

MPT

Modular Precision Tooling

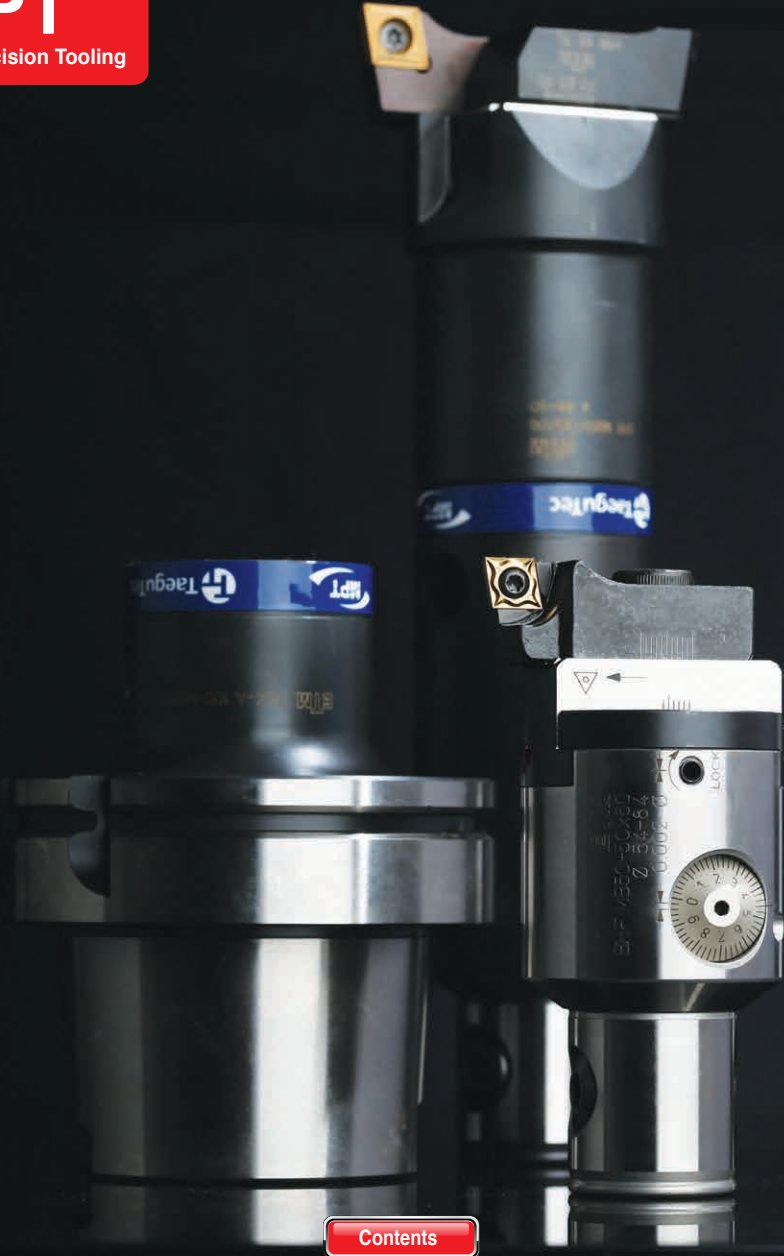

Contents

MPT

Modular Precision Tooling



contents

Tool Selection Guide	H4
Shanks	H6
Extensions and Reducers	H19
Toolholders	H22
Rough Boring Heads	H30
Combi Boring Heads	H36

• For more technical information, see TaeguTec technical guide part TH

Guide to Icons



➤ Insert page



➤ Spare parts page



➤ Toolholders page



➤ Slide page



➤ Cutting condition page



Fine Boring Heads

H38

Kits

H61

Spare Parts

H68

Cutting Conditions

H81

Tool Selection Guide

MPT system

Shanks

SKA/SKB

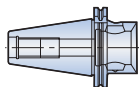

HSK

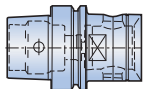

IM XMZ MB

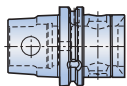

CATM

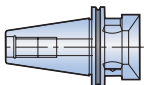

BT/BTB

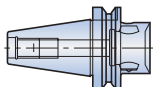

ISOM/ISO

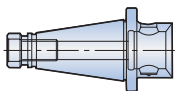

C MB

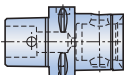

MTT

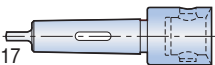

ST

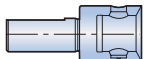

R-8

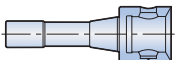

DIN2079



Extensions and reducers

EX  H19

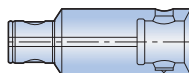

RE  H20

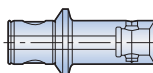

RE AVI  H21

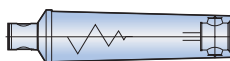

CHS  H21

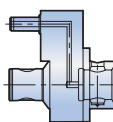

CHR  H21

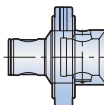

Tool Selection Guide

MPT system

Toolholders

EMH  H22

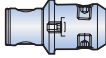

CC  H23

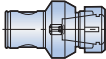

DC  H23



SMH  H24

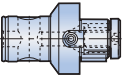

AMT  H28

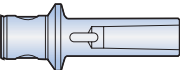

TP  H25

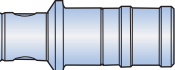

TCS/TCC  H26-H27

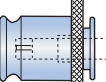

BLANK  H29



Rough boring heads

BHR  H30

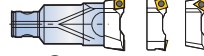

TCH  H31

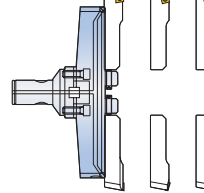

CHA  H34

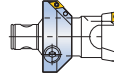

Combi boring heads

BHC  H36

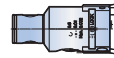

Fine boring heads

BHE  H38-H39

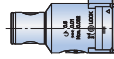

BHF  H43-45

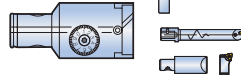

TCH  H57

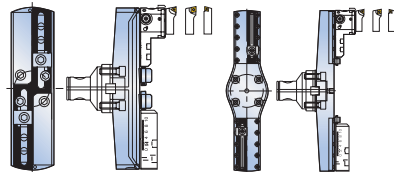

BHF 50,63,80

 H45

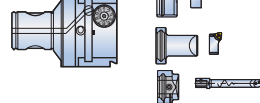

Taper shank with MB connection

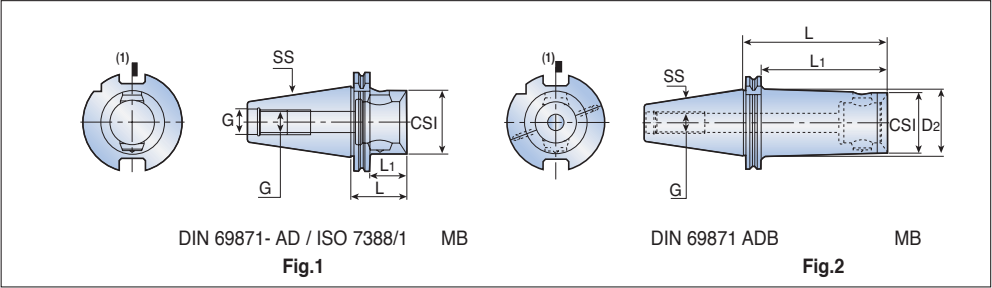

DIN 69871- AD / ISO 7388/1 MB

Fig.1

DIN 69871 ADB MB

MB

Fig.2

Designation	Dimension (mm)					G	Kg	Fig.
	SS	CSI	L	L1	D2			
SKA 30-MB32	30	MB32	30	10.5	-	M12	0.6	1
30-MB50	30	MB50	60	41	-	M12	0.7	1
40-MB40	40	MB40	45	26	-	M16	0.9	1
40-MB50	40	MB50	48	29	-	M16	1.2	1
40-MB63	40	MB63	80	61	-	M16	1.6	1
45-MB50	45	MB50	48	29	-	M20	1.9	1
45-MB63	45	MB63	60	41	-	M20	0.2	1
45-MB80	45	MB80	66	47	-	M20	2.3	1
50-MB50	50	MB50	48	29	-	M24	2.8	1
50-MB63	50	MB63	56	37	-	M24	3.0	1
50-MB80	50	MB80	62	43	-	M24	3.6	1
40 MB40x120 A/B	40	MB40	120	101	44.50	M16	1.7	2
40 MB50x120 A/B	40	MB50	120	101	-	M16	2.8	2
50 MB50x120 A/B	50	MB50	120	101	60.00	M24	4.0	2
50 MB63x150 A/B	50	MB63	150	131	70.00	M24	2.8	2
50 MB80x180 A/B	50	MB80	180	161	-	M24	7.9	2
50 MB110x150	50	MB110	150	131	-	M24	8.2	2
60 MB80x65	60	MB80	65	46	-	M30	10.7	2
60 MB110x100	60	MB110	100	81	-	M30	10.5	2
60 MB110x200	60	MB110	200	181	-	M30	18.0	2

• ⁽¹⁾Cutting edge position

Taper shank with MB connection

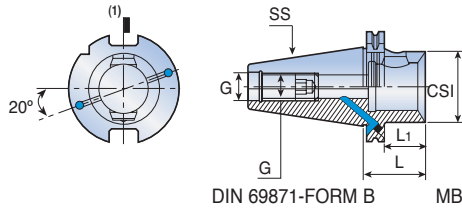

Designation	Dimension (mm)				G	 Kg
	SS	CSI	L	L1		
SKB 40-MB50	40	MB50	48	29	M16	0.9
40-MB63	40	MB63	80	-	M16	1.5
45-MB50	45	MB50	48	29	M20	1.7
45-MB63	45	MB63	60	41	M20	1.9
50-MB50	50	MB50	48	29	M24	2.7
50-MB63	50	MB63	56	37	M24	2.8
50-MB80	50	MB80	62	43	M24	3.4

• ⁽¹⁾Cutting edge position

Taper shank with MB connection

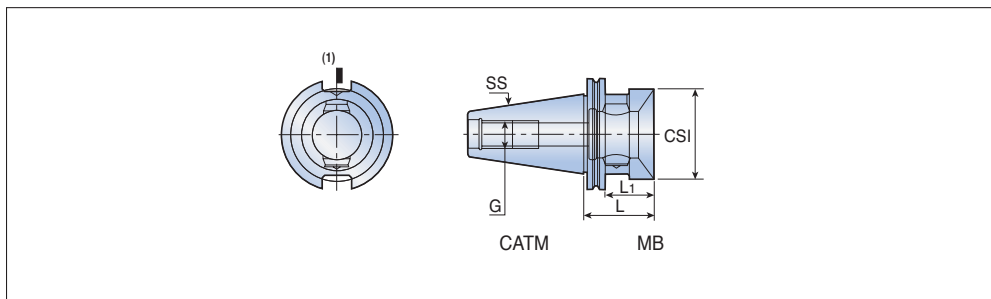

Designation	Dimension (mm)				G	Kg
	SS	CSI	L	L1		
CATM 40-MB50	40	MB50	66	47	M16	1.1
40-MB63	40	MB63	100	-	M16	1.9
45-MB50	45	MB50	48	29	M20	1.7
45-MB63	45	MB63	75	56	M20	2.1
45-MB80	45	MB80	80	-	M20	2.7
50-MB50	50	MB50	48	29	M24	2.9
50-MB63	50	MB63	56	37	M24	2.9
50-MB80	50	MB80	62	43	M24	3.2

• (1)Cutting edge position

ST-MB straight carbide shank with MB connection assembly options

ST16-ST32 MB16-MB32
Diameter range: 18-50 mm

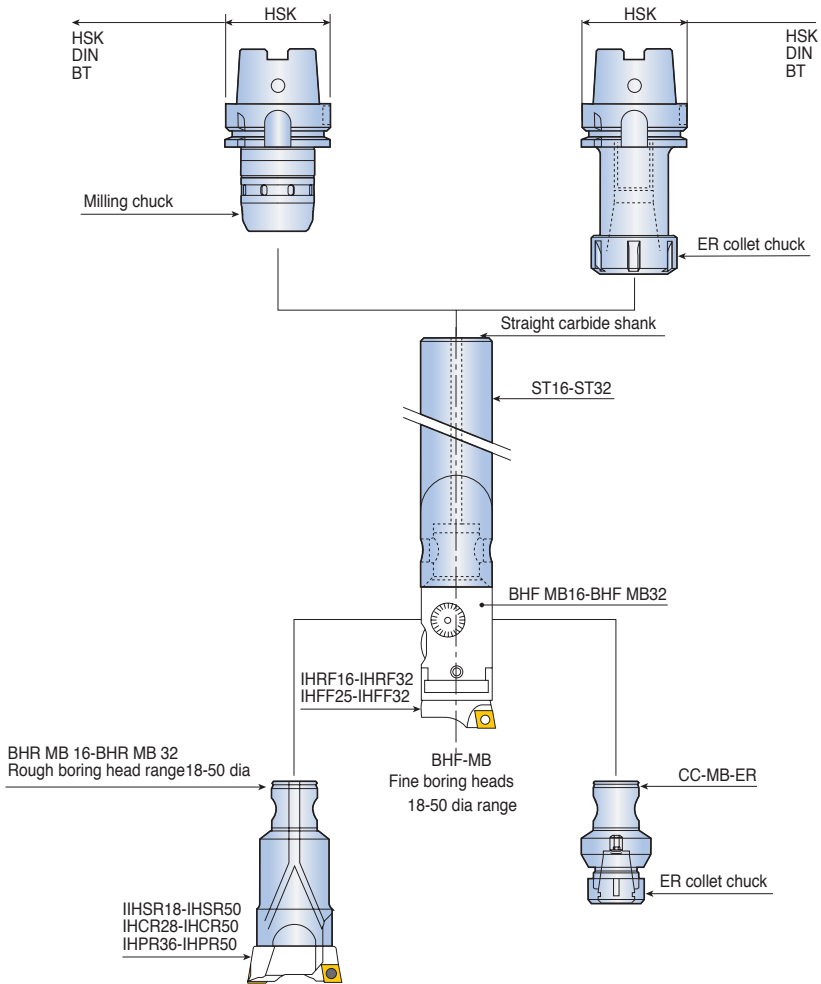

Bridgeport shanks with MB connection

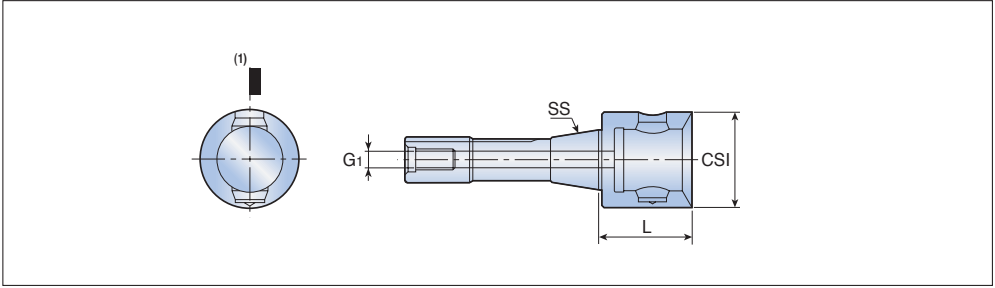

Designation	Dimension (mm)			G1	Kg
	SS	CSI	L		
R8 MB50	R8	MB50	50	UNF 7/16-20	0.8

• (1)Cutting edge position

MTT 5-MB63

Morse taper shanks with MB connection

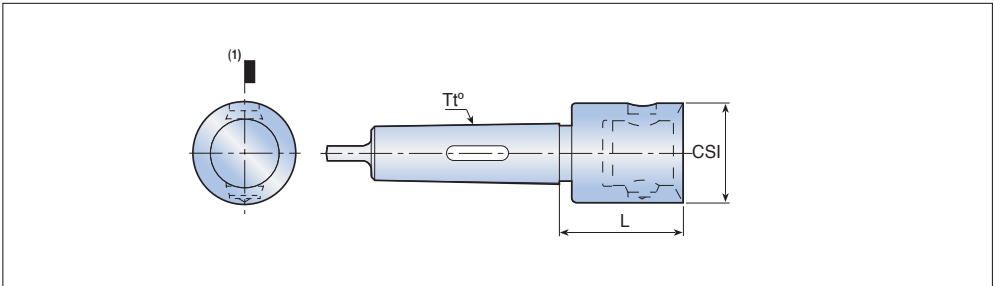

Designation	Dimension (mm)			Kg
	CSI	Tt°	L	
MTT 5-MB63	MB63	MT5	65	2.1

• (1)Cutting edge position

Connecting plates

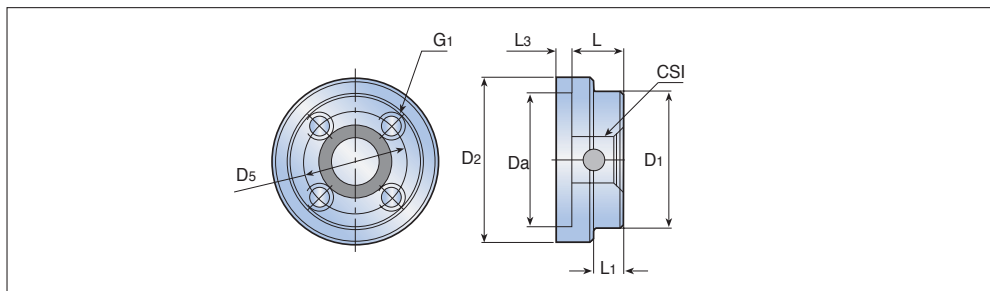

Designation	Dimension (mm)										Kg
	CSI	L	L3	L1	D1	D2	Da	D5	G1		
DIN 2079 MB50 40	MB50	35	10	21	90	110	88.89	66.7	M12	1.8	
MB63 40	MB63	45	10	31	90	110	88.89	66.7	M12	2.0	
MB63 50	MB63	45	12	31	135	150	128.57	101.6	M16	5.4	
MB80 50	MB80	45	12	31	135	150	128.57	101.6	M16	5.3	

- A standard connecting plate that can be assembled easily on most CNC spindle machines with a DIN 2079 interface. This connection plate enables the use of MPT components with the MB connection by using any standard adapter with four screws. It is fixed directly on the machine spindle.

Extensions for MB connection

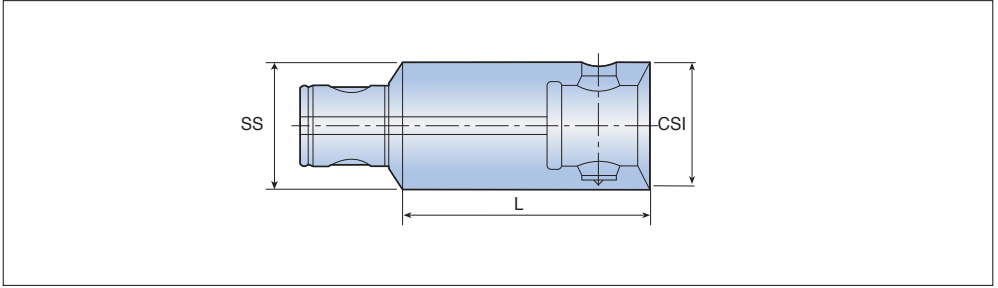

Designation	Dimension (mm)			 Kg
	SS	CSI	L	
EX 14x25-MB14	MB14	MB14	25	0.2
16x25-MB16	MB16	MB16	25	0.4
20x32-MB20	MB20	MB20	32	0.7
25x25-MB25	MB25	MB25	25	0.9
25x40-MB25	MB25	MB25	40	0.2
32x32-MB32	MB32	MB32	32	0.2
32x50-MB32	MB32	MB32	50	0.3
40x40-MB40	MB40	MB40	40	0.4
40x63-MB40	MB40	MB40	63	0.6
50x50-MB50	MB50	MB50	50	0.7
50x80-MB50	MB50	MB50	80	1.1
50x100-MB50	MB50	MB50	100	1.5
63x63-MB63	MB63	MB63	63	1.4
63x100-MB63	MB63	MB63	100	2.2
63x125-MB63	MB63	MB63	125	2.9
80x80-MB80	MB80	MB80	80	3.0
80x125-MB80	MB80	MB80	125	4.6
80x160-MB80	MB80	MB80	160	6.1
110x140-MB110	MB110	MB110	140	0.0
110x200-MB110	MB110	MB110	200	0.0

Reducers for MB connection

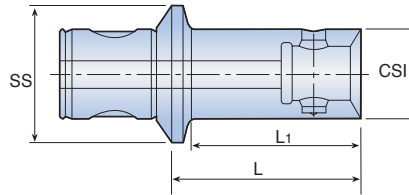

Designation	Dimension (mm)				Kg
	SS	CSI	L	L1	
RE MB16-MB14x24	MB16	MB14	24	19.5	0.3
MB20-MB14x19	MB20	MB14	19	13.5	0.4
MB20-MB16x20	MB20	MB16	20	16	0.5
MB25-MB14x19	MB25	MB14	19	13.5	0.6
MB25-MB16x20	MB25	MB16	20	15	0.8
MB25-MB20x25	MB25	MB20	25	20	0.9
MB32-MB14x25	MB32	MB14	25	17	1.0
MB32-MB16x24	MB32	MB16	24	18	1.3
MB32-MB20x25	MB32	MB20	25	20	1.6
MB32-MB25x28	MB32	MB25	28	23	2.1
MB40-MB14x23	MB40	MB14	23	16	2.8
MB40-MB16x24	MB40	MB16	24	17	3.5
MB40-MB20x26	MB40	MB20	26	20	0.4
MB40-MB25x28	MB40	MB25	28	22	0.5
MB40-MB32x32	MB40	MB32	32	27	0.6
MB50-MB14x23	MB50	MB14	23	14.5	0.8
MB50-MB14x39	MB50	MB14	39	30.5	0.9
MB50-MB16x24	MB50	MB16	24	15	1.0
MB50-MB16x40	MB50	MB16	40	31	1.3
MB50-MB16x74	MB50	MB16	74	65	1.6
MB50-MB20x26	MB50	MB20	26	18	3.5
MB50-MB20x70	MB50	MB20	70	62	0.4
MB50-MB20x93	MB50	MB20	93	85	0.5
MB50-MB25x28	MB50	MB25	28	21	0.6
MB50-MB25x87	MB50	MB25	87	80	0.8
MB50-MB25x117	MB50	MB25	117	110	3.5
MB50-MB32x32	MB50	MB32	32	25	0.4
MB50-MB32x87	MB50	MB32	87	80	0.5
MB50-MB32x144	MB50	MB32	144	137	0.6
MB50-MB40x36	MB50	MB40	36	30	0.8
MB50-MB40x87	MB50	MB40	87	80	0.9
MB50-MB40x176	MB50	MB40	176	170	1.0
MB63-MB50x40	MB63	MB50	40	34	1.3
MB80-MB50x45	MB80	MB50	45	36	1.6
MB80-MB63x60	MB80	MB63	60	52	1.6
MB110-MB80x70	MB110	MB80	70	52	0.0

Vibration dampening reducers

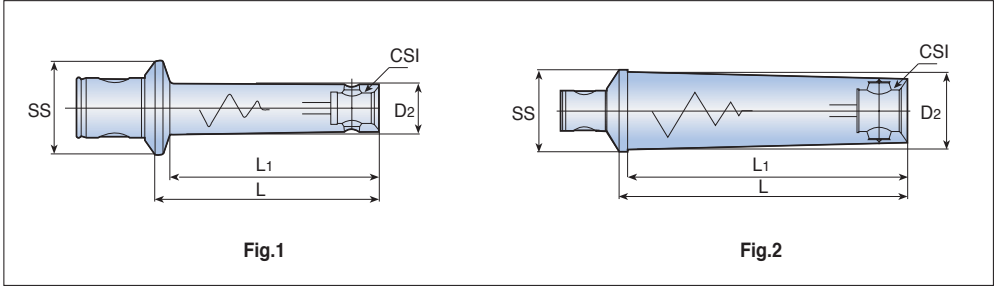

Designation	Dimension (mm)					Kg	Fig
	SS	CSI	D2	L	L1		
RE MB50-MB16x74-AVI	MB50	MB16	17.5	74	65	0.4	1
MB50-MB20x93-AVI	MB50	MB20	21.5	93	85	0.5	1
MB50-MB25x117-AVI	MB50	MB25	27	117	110	0.8	1
MB50-MB32x144-AVI	MB50	MB32	35	144	138	1.4	1
MB50-MB40x176-AVI	MB50	MB40	47	176	170	2.5	1
MB63-MB50x220-AVI	MB63	MB50	60	220	214	5.6	1
MB80-MB63x280-AVI	MB80	MB63	77	280	272	10.6	2

CHS MB-R/CHR MB

Extensions and Reducers

Coolant extensions for MB connection

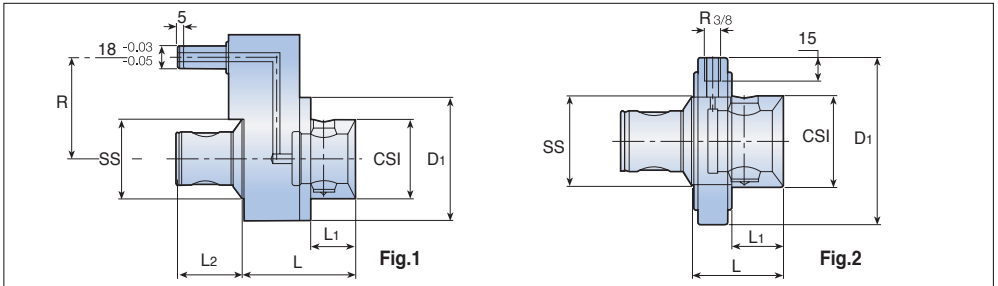

Designation	Dimension (mm)									Kg	Fig
	SS	CSI	R	D1	L	L1	L2	RPM _{Max}	Bar		
CHS MB50-R65	MB50	MB50	65	80	72	28.5	43	7000	10	1.9	1
MB50-R80	MB50	MB50	80	80	72	28.5	43	7000	10	2.5	1
MB63-R80	MB63	MB63	80	100	88	37.0	51	5600	10	5.0	1
CHR MB63	MB63	MB63	-	115	63	35	-	3500	10	5.0	2

- Important: Start coolant flow prior to rotating the spindle to avoid damage of the O rings.
- Use with stop block (not included)

Weldon holder with MB connection

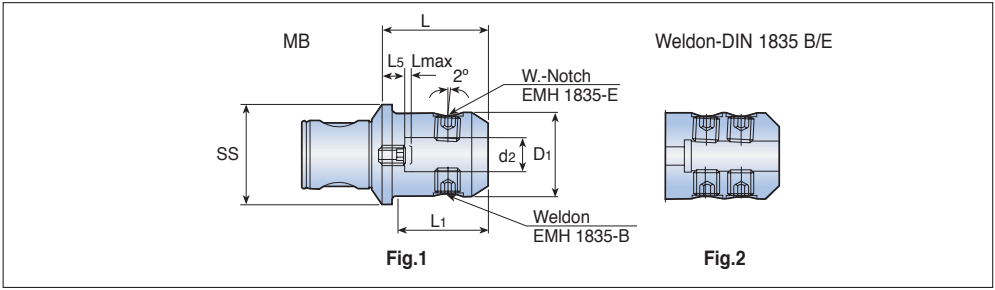

Designation	Dimension (mm)							Kg	Fig.
	SS	d2	D1	L	L1	L5	Lmax		
EMH MB50-8	MB50	8	28	44	33	7	2	0.5	1
MB50-10	MB50	10	35	52	42	11	3	0.7	1
MB50-12	MB50	12	42	57	48	11	3	0.8	1
MB50-14	MB50	14	42	57	48	11	3	0.8	1
MB50-16	MB50	16	48	67	61	17	4	1.1	1
MB50-20	MB50	20	51	67	-	16	4	1.2	1
MB63-16	MB63	16	48	64	53	14	4	1.4	1
MB63-20	MB63	20	52	66	56	14	4	1.5	1
MB63-25	MB63	25	64	74	-	16	4	2.1	2
MB63-32	MB63	32	72	76	-	14	4	2.5	2
MB80-40	MB80	40	80	83	-	12	4	3.2	2



ER Collet chucks with MB connection

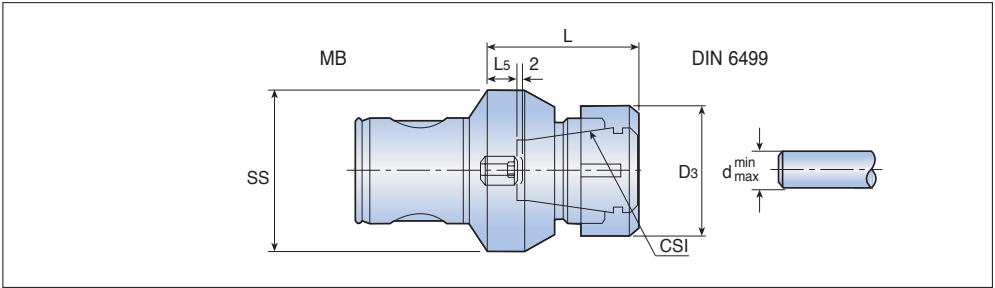

Designation	Dimension (mm)							Kg
	SS	CSI	d _{min}	d _{max}	D ₃	L	L ₅	
CC MB16 ER11M	MB16	ER11	0.5	7.0	16	25	2.5	0.03
MB20 ER16M	MB20	ER16	0.5	10.0	22	32	1.0	0.06
MB25 ER20M	MB25	ER20	1.0	13.0	28	40	2.5	0.15
MB32 ER25M	MB32	ER25	1.0	16.0	35	42	1.5	0.25
MB40 ER25	MB40	ER25	1.0	16.0	42	45	5.0	0.25
MB50 ER25	MB50	ER25	1.0	16.0	42	48	7.0	0.70
MB50 ER32	MB50	ER32	2.0	20.0	50	59	7.0	1.00
MB63 ER32	MB63	ER32	2.0	20.0	50	59	12	1.30
MB63 ER40	MB63	ER40	3.0	26.0	63	64	12	1.50

DC MB

Drill chucks with MB connection

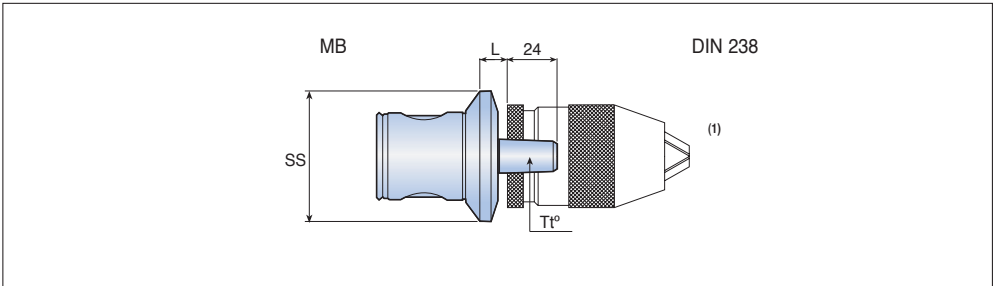

Designation	Dimension (mm)			Kg
	SS	L	Tt°	
DC MB50 B16	MB50	10.0	B16	0.4
MB63 B16	MB63	13.5	B16	0.8

Spare Parts • ⁽¹⁾Without drill chuck



H68-H80

Shell mill holders with MB connection

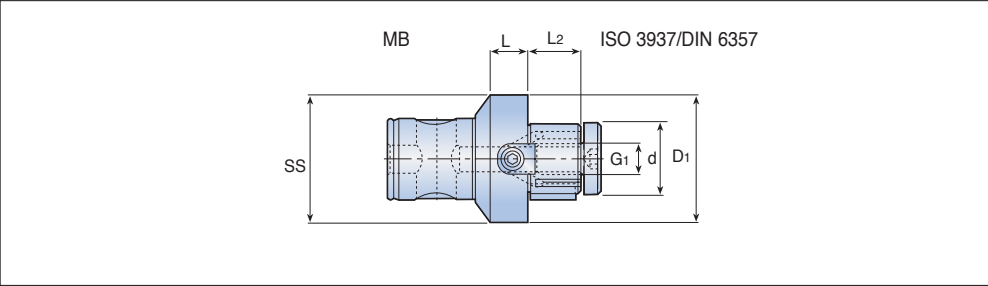

Designation	Dimension (mm)						Kg
	SS	d	D1	G1	L	L2	
SMH MB40-16	MB40	16	32	M8	15	17	0.5
MB40-22	MB40	22	40	M10	13	19	0.4
MB50-16	MB50	16	32	M8	15	17	0.5
MB50-22	MB50	22	40	M10	15	19	0.5
MB50-27	MB50	27	50	M12	15	21	0.6
MB50-32	MB50	32	70	M16	15	24	0.7
MB63-27	MB63	27	60	M12	15	21	1.1
MB63-32	MB63	32	70	M16	15	24	1.2
MB80-32	MB80	32	70	M16	15	24	1.9
MB80-40	MB80	40	88	M20	24	27	2.1
MB80-60	MB80	60	128.5	M30	31.5	40	3.5
MB110-60	MB110	60	128.5	M30	36.0	40	7.7



STUB 60 Holder with an MB80 connection

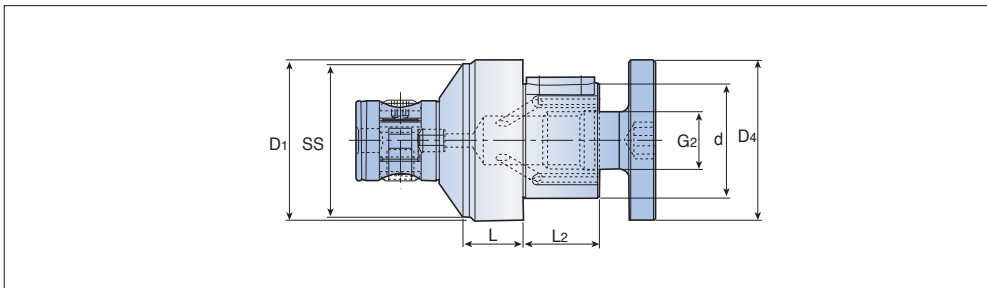

Designation	Dimension (mm)							Kg
	SS	d	D1	D4	G2	L	L2	
STUB MB80-60	MB80	60	84	84	M30	31.5	40	6.3

TP MB-M

Toolholders

Tapping chucks with MB modular system connection

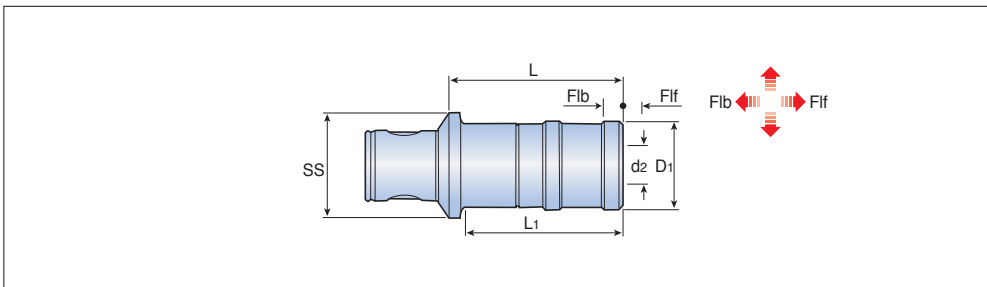

Designation	Dimension (mm)									Kg
	SS	TAP _{min}	TAP _{max}	L ₁	L	D ₁	d ₂	Flf	Flb	
TP MB50-M 3-12	MB50	M3	M12	60	72	36	19	7.5	7.5	0.8
MB50-M 8-20	MB50	M8	M20	-	106	53	31	12.5	12.5	1.6
MB63-M 3-12	MB63	M3	M12	58	70	36	19	7.5	7.5	1.2
MB63-M 8-20	MB63	M8	M20	93	104	53	31	12.5	12.5	1.9

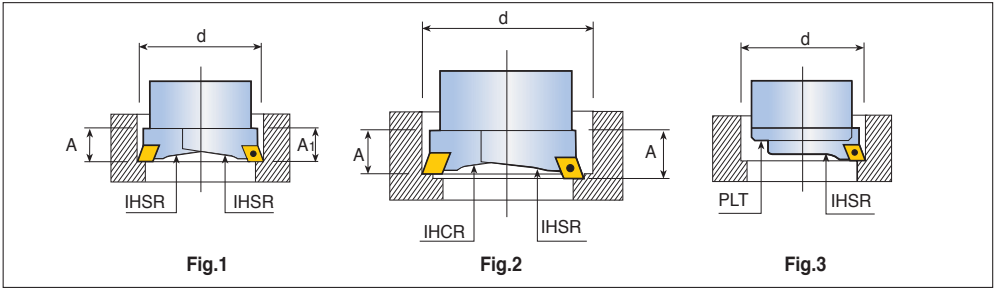

- When using the MPT system, it is strongly recommended that the user utilizes the tool pre-setting equipment provided to set the radial cutting edges. The boring bars that are equipped with two inserts holders are for rough machining and heavy stock removal.
- The bars are applicable to three types of machining scenarios:
 - When two IHSR insert holders are on the same plane, the two cutting edges are placed at identical radial distances for high feed rough machining (Fig. 1).
 - When each IHCR and IHSR insert is not set on the same plane, each of the two cutting edges is placed at a different radial distance for deep rough machining (Fig. 2).
 - If boring bars are set with a single insert holder it allows rough and finish machining with normal chip removal. In this situation, it is strongly recommended that a serrated surface protection plate (PLT) is used (Fig. 3).

BHR MB

Rough Boring Heads

Rough boring heads 18-200mm range with MB connection

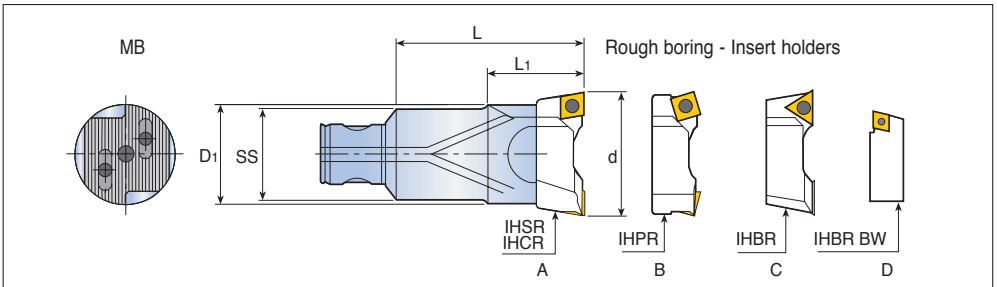

Designation	Dimension (mm)						Insert holders				Kg	
	SS	d _{min}	d _{max}	D1	L	L1	Insert holders	A	B	C		D
BHR MB16-16x34	MB16	18	22	16	34	-	IH...18-22	●			●	0.05
MB20-20x40	MB20	22	28	20	40	-	IH...22-28	●			●	0.09
MB25-25x50	MB25	28	38	25	50	-	IH...28-38	●			●	0.20
MB32-32x63	MB32	36	50	32	63	-	IH...36-50	●	●		●	0.35
MB40-40x80	MB40	50	68	40	80	-	IH...50-68	●	●		●	0.70
MB50-50x100	MB50	68	90	55	100	50	IH...68-90	●	●		●	1.50
MB50-63x80	MB50	90	120	72	80	60	IH...90-120	●	●	●	●	2.00
MB63-63x125	MB63	90	120	72	125	63	IH...90-120	●	●	●	●	3.00
MB80-80x140	MB80	120	200	95	140	75	IH...120-800	●	●	●	●	5.30



TCH

Rough Boring Heads

Rough boring aluminum body range: 200-500mm with MB connection

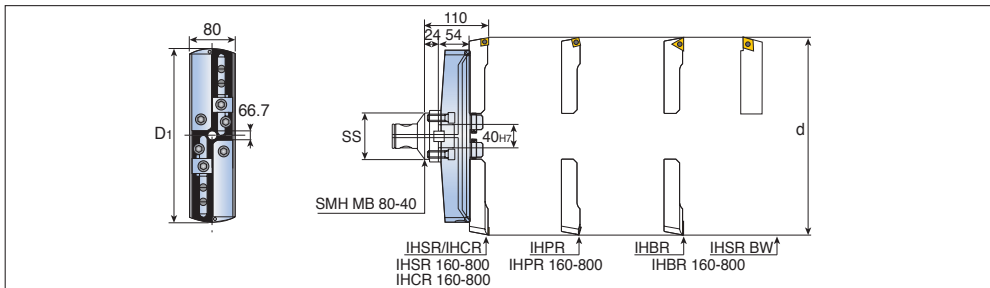

Designation	Dimension (mm)					Kg
	SS	d _{min}	d _{max}	D ₁	IH...160-800	
TCH 200	80	200	300	194	IHRS 160-800 IHCR 160-800	3.4
300	80	300	400	298	IHPR 160-800	4.3
400	80	400	500	398	IHBR 160-800	6.7

TCH A.L

Rough Boring Heads

Rough boring aluminum body range: 500-800mm with MB connection

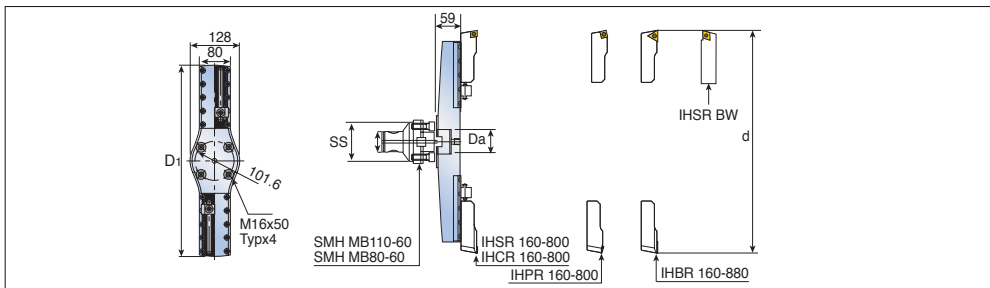

Designation	Dimension (mm)					Kg
	SS	d _{min}	d _{max}	D ₁	Da	
TCH A.L 500	80,110	500	600	494	60	8.7
600	80,110	600	700	594	60	8.34
700	80,110	700	800	694	60	8.34



• Aluminum body with steel serrated seats

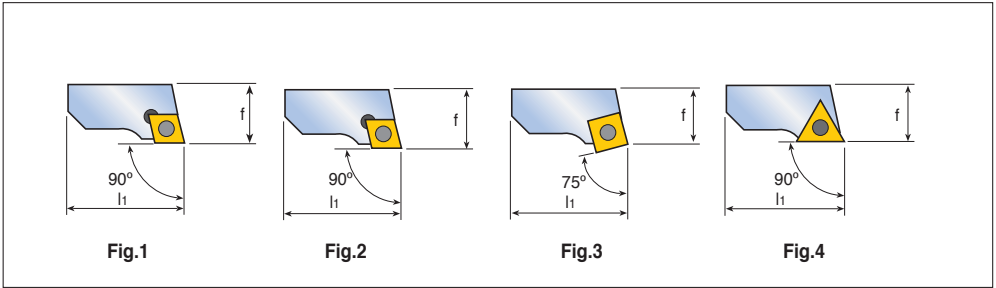

Designation	Dimension (mm)				Spare parts			Fig.
	d _{min}	d _{max}	f	l ₁	Insert	Insert screw	Torx key	
IHSR 18-22	18	22	8.0	15.0	CCMT 0602...	SR 14-548	T7/5	1
22-28	22	28	9.5	19.0	CCMT 0602...	SR 14-548	T7/5	1
28-38	28	38	12.5	23.0	CCMT 0602...	SR 14-548	T7/5	1
36-50	36	50	15.0	32.0	CCMT 0602...	SR 14-548	T7/5	1
50-68	50	68	19.0	40.0	CCMT 09T3...	TS 40097I	T15/5	1
50-68-12	50	68	19.0	40.0	CCMT 1204..	SR 16-212	T20/5	1
68-90	68	90	22.0	54.0	CCMT 1204..	SR 16-212	T20/5	1
90-120	90	120	27.0	70.5	CCMT 1204...	SR 16-212	T20/5	1
120-160	120	160	32.0	94.5	CCMT 1204..	SR 16-212	T20/5	1
160-800	160	800	32.0	130.0	CCMT 1204..	SR 16-212	T20/5	1
IHCR 28-38	28	38	12.3	23.0	CCMT 0602..	SR 14-548	T7/5	2
36-50	36	50	14.8	32.0	CCMT 0602...	SR 14-548	T7/5	2
36-50-09	36	50	14.8	32.0	CCMT 09T3..	TS 40097I	T15/5	2
50-68	50	68	18.7	40.0	CCMT 09T3..	TS 40097I	T15/5	2
50-68-12	50	68	18.7	40.0	CCMT 1204..	SR 16-212	T20/5	2
68-90	68	90	21.7	54.0	CCMT 1204..	SR 16-212	T20/5	2
90-120	90	120	26.7	70.5	CCMT 1204..	SR 16-212	T20/5	2
120-160	120	160	31.7	94.5	CCMT 1204..	SR 16-212	T20/5	2
160-800	160	800	31.7	130.0	CCMT 1204..	SR 16-212	T20/5	2
IHPR 36-50	36	50	15	32.0	SCMT 09T3..	TS 40097I	T15/5	3
50-68	50	68	19	40.0	SCMT 09T3...	TS 40097I	T15/5	3
68-90	68	90	22	54.0	SCMT 1204..	SR 16-212	T20/5	3
90-120	90	120	27	70.5	SCMT 1204..	SR 16-212	T20/5	3
120-160	120	160	32	94.5	SCMT 1204..	SR 16-212	T20/5	3
160-800	160	800	32	130.0	SCMT 1204..	SR 16-212	T20/5	3
IHBR 90-120	90	120	27	70.5	TCMT 2205..	SR 16-212	T20/5	4
120-160	120	160	32	94.5	TCMT 2205..	SR 16-212	T20/5	4
160-800	160	800	32	130.0	TCMT 2205..	SR 16-212	T20/5	4



Chamfering tools

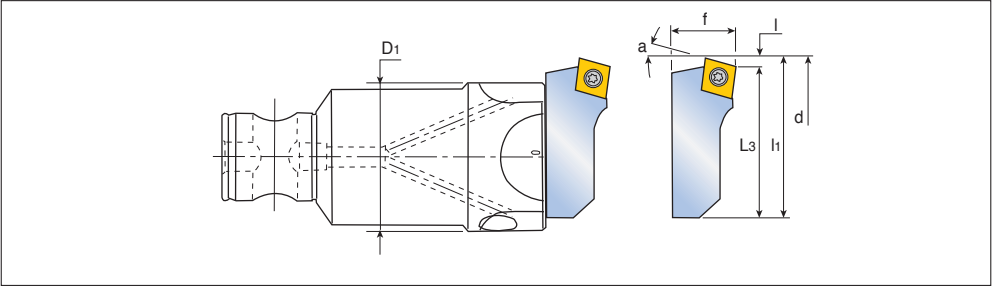

Designation	Dimension (mm)								Spare parts		
	d_{min}	d_{max}	a°	L_3	l_1	f	l	D_1	Insert	Insert screw	Torx key
IHSR 26-38 CH15	26.0	38.0	15	23	24.7	13.5	1.7	25	CCMT 0602..	SR 14-548	T-7/5
26-38 CH30	26.0	38.0	30	23	26.2	13.5	3.2	25	CCMT 0602..	SR 14-548	T-7/5
26-38 CH45	26.0	38.0	45	23	27.5	13.5	4.5	25	CCMT 0602..	SR 14-548	T-7/5
34.5-49 CH15	34.5	49.0	15	31	32.7	16.0	1.7	32	CCMT 0602..	SR 14-548	T-7/5
34.5-49 CH30	34.5	49.0	30	31	34.2	16.0	3.2	32	CCMT 0602..	SR 14-548	T-7/5
34.5-49 CH45	34.5	49.0	45	31	35.5	16.0	4.5	32	CCMT 0602..	SR 14-548	T-7/5
46.5-66 CH15	46.5	66.0	15	39	41.5	20.0	2.5	40	CCMT 09T3..	SR 16-236	T-15/5
46.5-66 CH30	46.5	66.0	30	39	43.8	20.0	4.8	40	CCMT 09T3..	SR 16-236	T-15/5
46.5-66 CH45	46.5	66.0	45	39	45.8	20.0	6.8	40	CCMT 09T3..	SR 16-236	T-15/5
65-88 CH15	65.0	88.0	15	53	55.5	23.0	2.5	50	CCMT 1204..	SR 16-236	T-15/5
65-88 CH30	65.0	88.0	30	53	57.8	23.0	4.8	50	CCMT 1204..	SR 16-236	T-15/5
65-88 CH45	65.0	88.0	45	53	59.8	23.0	6.8	50	CCMT 1204..	SR 16-236	T-15/5



Chamfering tools

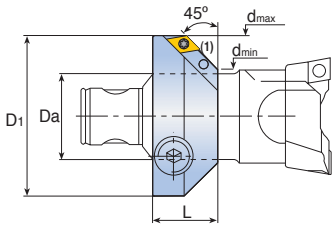

Designation	Dimension (mm)					Spare parts			
	d _{min}	d _{max}	Da	D ₁	L	Insert	Insert screw	Torx key	
CHA 16-45	18	28	16	28	13	DCMT 0702..	SR 14-548	T7/5	0.035
20-45	22	32	20	32	15	DCMT 0702..	SR 14-548	T7/5	0.045
25-45	28	43	25	43	18	DCMT 0702..	SR 14-548	T7/5	0.10
32-45	35	54	32	54	22	DCMT 0702..	SR 14-548	T7/5	0.20
40-45	46	72	40	72	30	DCMT 11T3..	SR 16-236P	T15/5	0.50
50-45	56	95	50	95	38	DCMT 11T3..	SR 16-236P	T15/5	1.10



- To minimize mismatch use insert radius 0.2 mm.
- (1) Only one insert can be mounted on either one of the two pockets simultaneously.

Back face for BHR and TCH rough boring heads

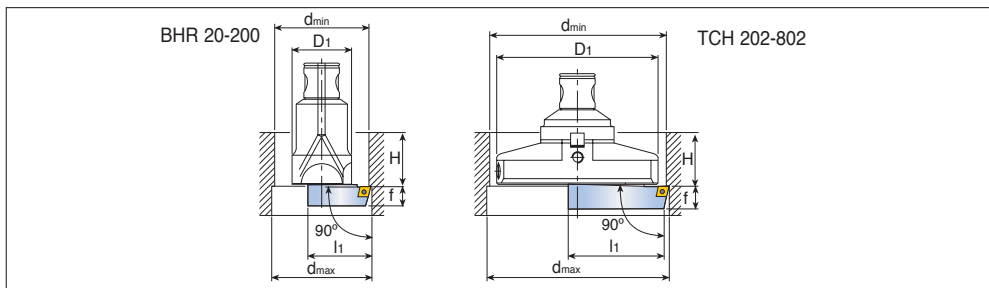

Designation	Dimension (mm)							Spare parts		
	SS	d _{min}	d _{max}	D ₁	H	f	l ₁	Insert	Insert screw	Torx key
IHSR 20-24 BW	BHR MB16-16	20.0	24	16	27.5	8.0	16.0	CCMT 0602..	SR 14-548	T7/5
23.5-30 BW	BHR MB20-20	23.5	30	20	32.5	9.5	19.5	CCMT 0602..	SR 14-548	T7/5
29.5-40 BW	BHR MB25-20	29.5	40	25	39.0	12.0	24.0	CCMT 0602..	SR 14-548	T7/5
39-52 BW	BHR MB32-32	39	52	32	50.0	14.0	32.0	CCMT 09T3..	TS 400971	T15/5
51-70 BW	BHR MB40-40	51	70	40	63.5	17.5	42.0	CCMT 1204..	SR 16-212	T20/5
69-92 BW	BHR MB50-50	69	92	55	80.5	21.0	57.0	CCMT 1204..	SR 16-212	T20/5
91-122 BW	BHR MB63-63	91	122	72	100.5	25.0	76.0	CCMT 1204..	SR 16-212	T20/5
121-162 BW	BHR MB80-80	121	162	95	110.5	28.0	101.0	CCMT 1204..	SR 16-212	T20/5
161-802 BW	BHR MB80-80	161	200	95	110.5	28.0	122.0	CCMT 1204..	SR 16-212	T20/5
	TCH200	202	302	198	56.5	28.0	122.0	CCMT 1204..	SR 16-212	T20/5
	TCH300	302	402	298	56.5	28.0	122.0	CCMT 1204..	SR 16-212	T20/5
	TCH400	402	502	398	61.5	28.0	122.0	CCMT 1204..	SR 16-212	T20/5
	TCH500	502	602	494	61.5	28.0	122.0	CCMT 1204..	SR 16-212	T20/5
	TCH600	602	702	594	61.5	28.0	122.0	CCMT 1204..	SR 16-212	T20/5
	TCH700	702	802	694	61.5	28.0	122.0	CCMT 1204..	SR 16-212	T20/5

-  • D₁ = Size of the boring head being used
- d_{min} = (min bore diameter) = (d_{max} + D₁ + 1) / 2

Combi rough and fine boring heads

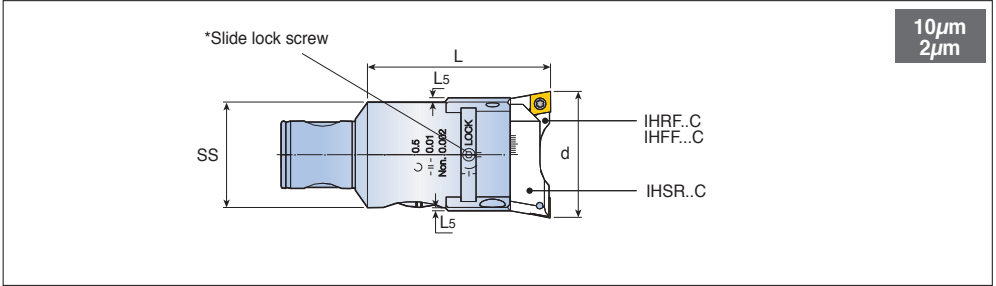

Designation	Dimension (mm)					Insert holder	Kg
	SS	d _{min}	d _{max}	L	L5		
BHC MB25-25-57	MB25	28	36	56.5	0.5	IH.. C	0.20
MB32-32-71	MB32	36	46	71.0	0.5	IH.. C	0.35
MB40-40-90	MB40	46	60	90.0	1.0	IH.. C	0.70
MB50-50-87	MB50	60	75	87.0	1.0	IH.. C	1.50
MB63-63-109	MB63	78	100	109.0	2.0	IH.. C	2.70
MB80-80-130	MB80	95	120	130.0	2.0	IH.. C	4.80



- The roughing head precedes the finishing head by 0.2 mm. Each head can be adjusted independently.
- The finishing insert holder can be radially adjusted within 5 microns.
- Insert radius for combi rough and fine boring must be the same size.
- Loosen the slide lock screw* before making any slide adjustment.

Insert holders for BHC combi boring heads

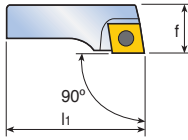

Fig.1

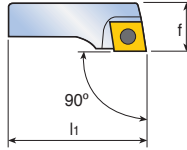

Fig.2

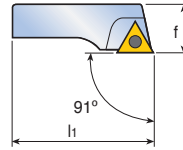
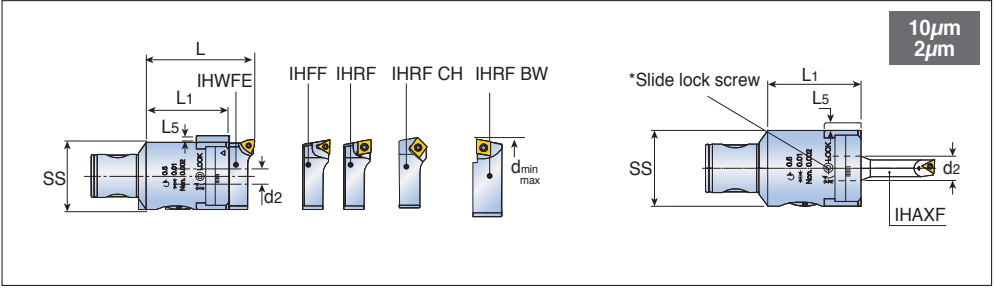



Fig.3

Designation	Dimension (mm)				Spare parts			Fig.
	d_{min}	d_{max}	f	l_1	Insert	Insert screw	Torx key	
IHRF 28-36 C⁽¹⁾	28	36	9.8	24.0	CCGT 0602..	SR 14-548	T7/5	1
36-46 C⁽¹⁾	36	46	11.3	30.0	CCGT 0602..	SR 14-548	T7/5	1
46-60 C⁽¹⁾	46	60	13.8	40.0	CCGT 09T3...	TS 40097I	T15/5	1
60-75 C⁽¹⁾	60	75	18.8	54.0	CCGT 09T3...	TS 40097I	T15/5	1
75-95 C⁽¹⁾	75	95	24.3	68.0	CCGT 09T3...	TS 40097I	T15/5	1
95-120 C⁽¹⁾	95	120	29.3	87.0	CCGT 09T3...	TS 40097I	T15/5	1
IHSR 28-36 C⁽²⁾	28	36	10.0	24.0	CCMT 0602..	SR 14-548	T7/5	2
36-46 C⁽²⁾	36	46	11.5	30.0	CCMT 0602..	SR 14-548	T7/5	2
46-60 C⁽²⁾	46	60	14.0	40.0	CCMT 09T3...	TS 40097I	T15/5	2
60-75 C⁽²⁾	60	75	19.0	54.0	CCMT 09T3...	TS 40097I	T15/5	2
75-95 C⁽²⁾	75	95	24.5	68.0	CCMT 09T3...	TS 40097I	T15/5	2
95-120 C⁽²⁾	95	120	29.5	87.0	CCMT 09T3...	TS 40097I	T15/5	2
IHFF 28-36 C⁽¹⁾	28	36	9.8	24.0	TPGX 0902...	SO 25061I	T8/5	3
36-46 C⁽¹⁾	36	46	11.3	30.0	TPGX 0902...	SO 25061I	T8/5	3
46-60 C⁽¹⁾	46	60	13.8	40.0	TPGX 1103...	SO 30081I	T8/5	3
60-75 C⁽¹⁾	60	75	18.8	54.0	TPGX 1103...	SO 30081I	T8/5	3
75-95 C⁽¹⁾	75	95	24.3	68.0	TPGX 1103...	SO 30081I	T8/5	3
95-120 C⁽¹⁾	95	120	29.3	87.0	TPGX 1103...	SO 30081I	T8/5	3

A248, A263 • (1) For finishing, (2) For roughing
A257

10μm direct diametric adjustment and 2μm with the vernier scale



Designation	Dimension (mm)							 kg
	SS	d _{min}	d _{max}	L	L ₁	L ₅	d ₂	
BHE MB14-14-30	MB14	14.5	18	30.0	22.0	1.0	-	0.09
MB16-16-34	MB16	18	24	34.0	26.0	2.0	-	0.10
MB20-20-40	MB20	22	30	40.0	31.5	3.0	-	0.15
MB25-25-50	MB25	28	40	50.0	40.0	3.0	-	0.23
MB32-32-63	MB32	35	53	63.0	51.5	4.0	-	0.42
MB40-40-80	MB40	48	66	80.0	66.0	5.0	-	0.83
MB50-50-80	MB50	6.0	110	80.0	61.0	5.0	16.0	1.15
MB63-63-89	MB63	6.0	125	89.0	69.5	10.0	-	2.13
MB80-80-104	MB80	6.0	200	104.0	85.0	12.0	-	3.83

Fine boring heads for high rotation speed

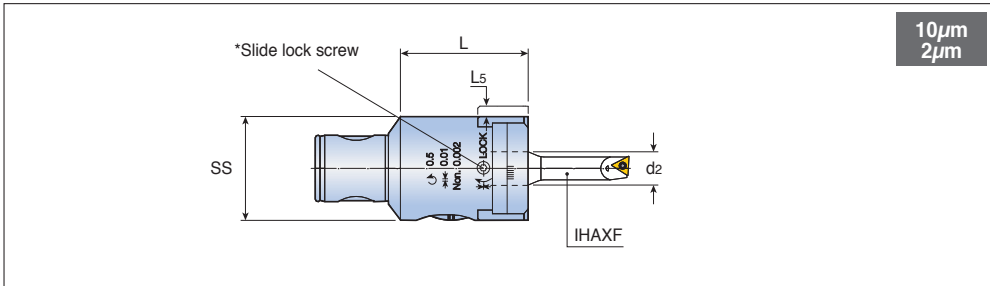

Designation	Dimension (mm)							Kg
	SS	d _{min}	d _{max}	d ₂	L	L ₅	RPM max	
BHE MB32-32-53H	MB32	2.5	12	8	53	0.5	12,000	0.35
MB50-50-60H	MB50	6.0	22	16	60	1.0	12,000	1.50

• Important: Loosen the slide lock screw* before making any slide adjustment.

Fine boring head range: 10 μ m direct diametric adjustment and 2 μ m with the vernier scale

10 μ m
2 μ m

BHE MB50-50x80
Ø6-113.5

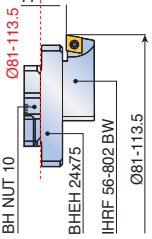
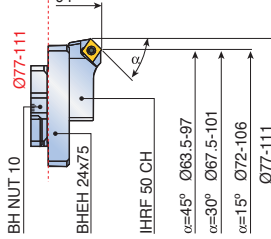
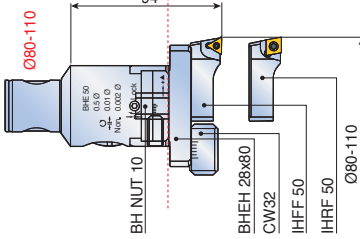
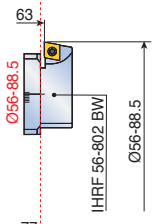
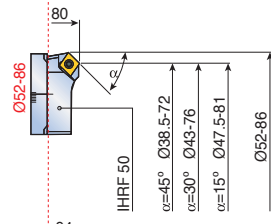
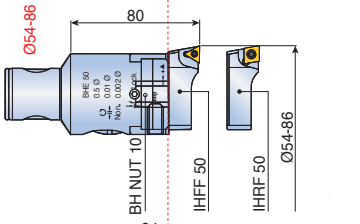
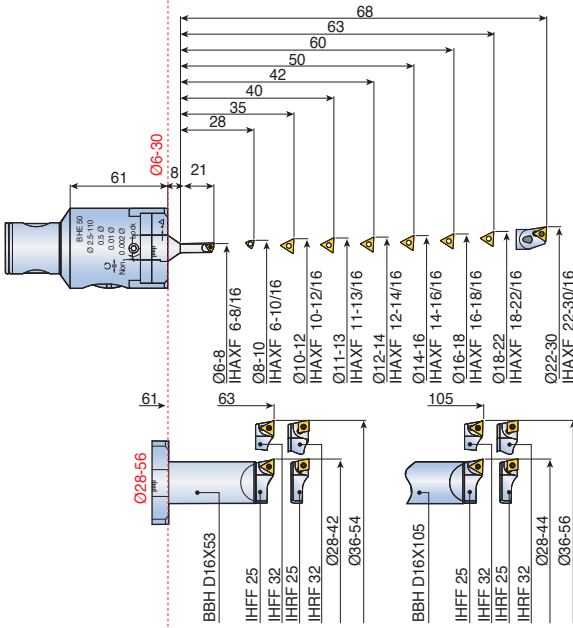

Fine boring head range: 10µm direct diametric adjustment and 2µm with the vernier scale

BHE MB60-63x89
ø6-129.5

10µm
2µm

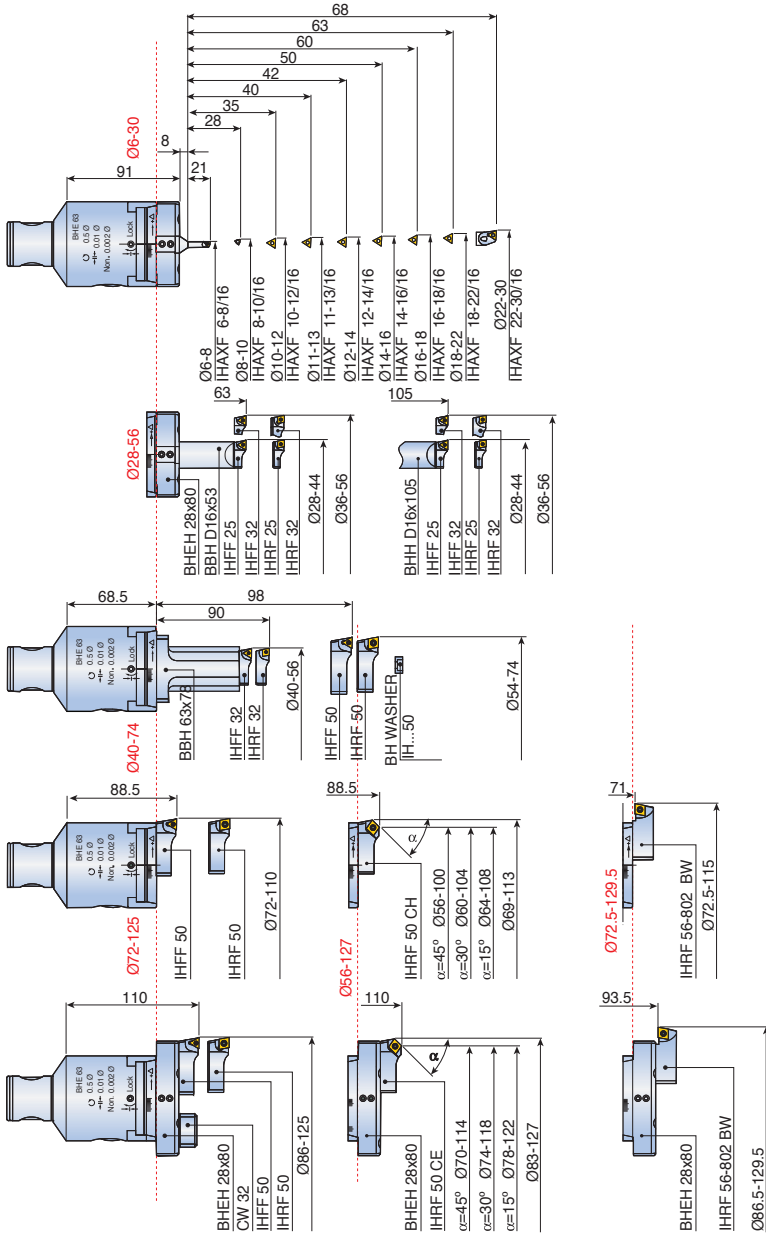

Fine boring head range: 10 μ m direct diametric adjustment and 2 μ m with the vernier scale

10 μ m
2 μ m

BHE MB80-80x104
Ø6-202.5

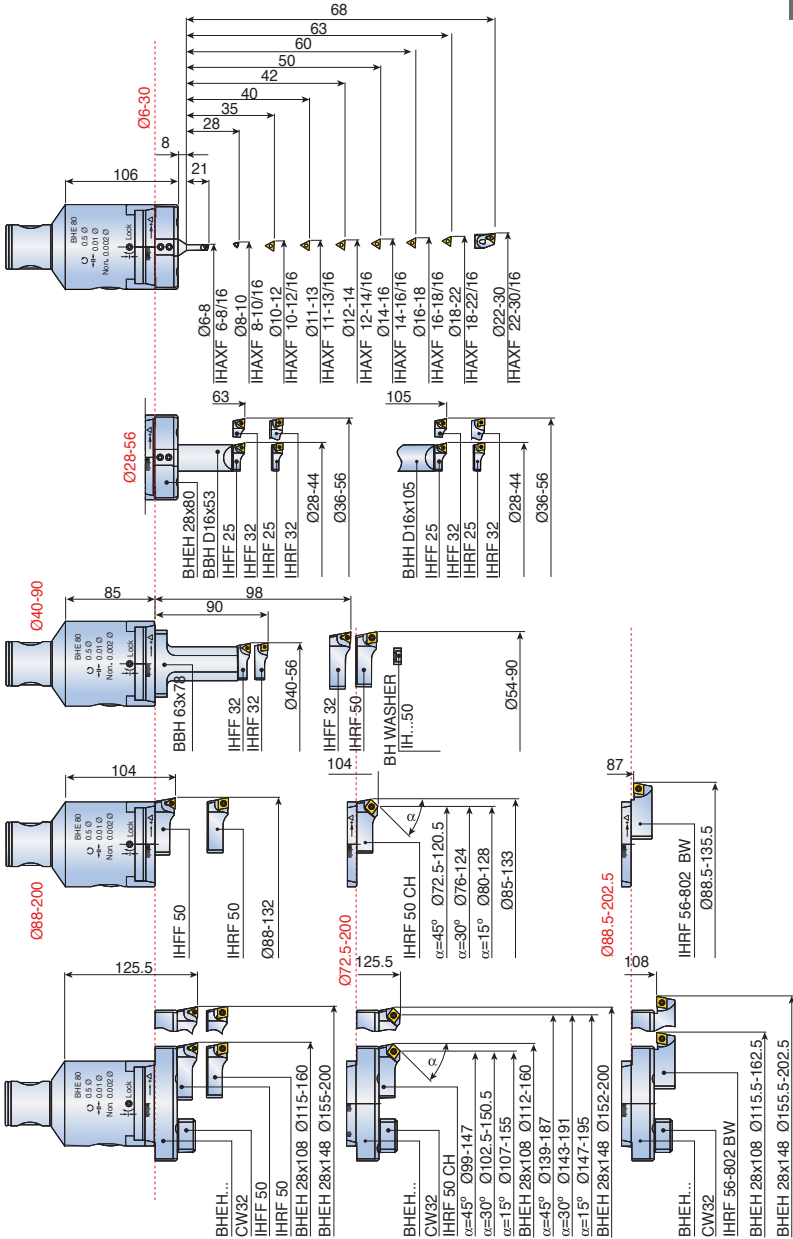

BHF fine boring heads

These intricate boring heads enable fine radial adjustments as small as 0.002mm whilst accomplishing high precision machining to the strictest of tolerances with a superb surface finish.

2µm



BHF MB16-MB40 Diameter range: 18-63

BHF MB16-16x34 RV

18-23

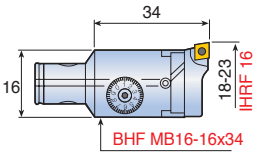

BHF MB16-16x34

BHF MB20-20x40 RV

22-29

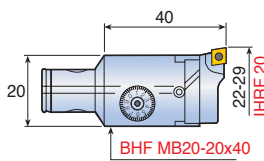

BHF MB20-20x40

BHF MB25-25x50

28-38

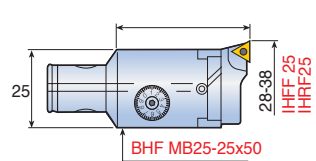

BHF MB25-25x50

BHF MB32-32x63

36-50

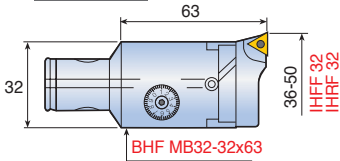

BHF MB32-32x63

BHF MB40-40x80

48-63

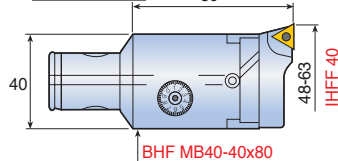

BHF MB40-40x80

Fine boring head diameter range

	0	10	20	30	40	50	60	70	80	90	100	110	120	130	150	180	280	400	600	700	800	
BHF MB 50-32x60 BL			2.5-12																			
50-50x68 BL				2.5-20																		
50-50x60											2.5-84											
50-63x87																	2.5-160					
80-80x94																		2.5-220				
16-16x34 RV								18-23														
20-20x40 RV									22-29													
25-25x50										28-38												
32-32x63											36-50											
40-40x80												48-63										
80-125x114																						36-500
TCH																						
200																						200-300
300																						300-400
400																						400-500
A.L 500																						500-600
A.L 600																						600-700
A.L 700																						700-800

Fine boring heads with balancing rings

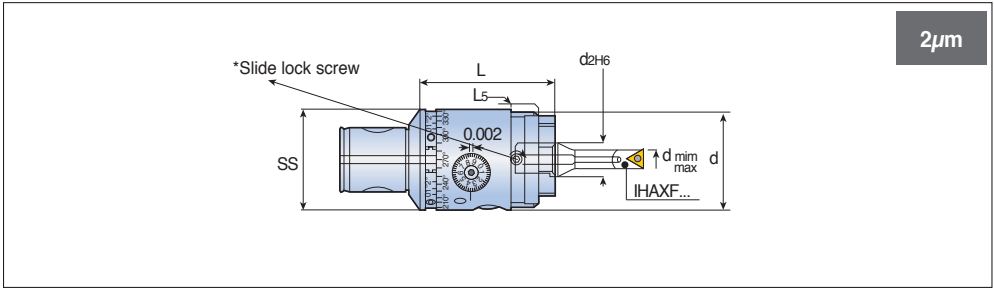

Designation	Dimension (mm)							Kg
	SS	d _{min}	d _{max}	d ₂	d	L	L ₅	
BHF MB50-32x60 BL	MB50	2.5	12.0	8	32	60.0	3	0.8
MB50-50x68 BL	MB50	6.0	22.0	16	50	68.5	4	1.1

BHF MB16-MB50, Dia.6-108

Fine Boring Heads

BHF MB: Fine boring heads

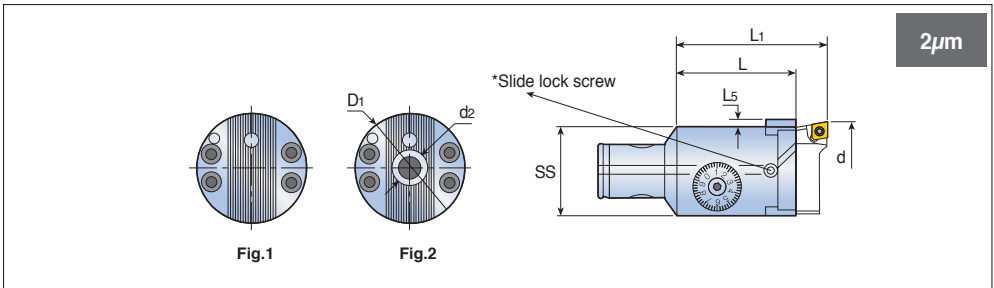

Designation	Dimension (mm)								Insert holder	Kg	Fig
	SS	d _{min}	d _{max}	D ₁	L	L ₁	L ₅	d ₂			
BHF MB16-16x34 RV	MB16	18	23	16	26.0	34	1	-	IH..16	0.05	1
MB20-20x40 RV	MB20	22	29	20	32.5	40	2	-	IH..20	0.1	1
MB25-25x50	MB25	28	38	25	40.0	50	2	-	IH..25	0.2	1
MB32-32x63	MB32	36	50	32	51.5	63	3	-	IH..32	0.35	1
MB40-40x80	MB40	48	63	40	66.0	80	4	-	IH..40	0.7	1
MB50-50x60	MB50	6	108	50	60	79	4	16	IH..50	1.0	2



• Important: Loosen the slide lock screw* before making any slide adjustment.

Fine boring heads with balancing rings

2 μ m

BHF MB50-32x60 BL Diameter range: 2.5-12

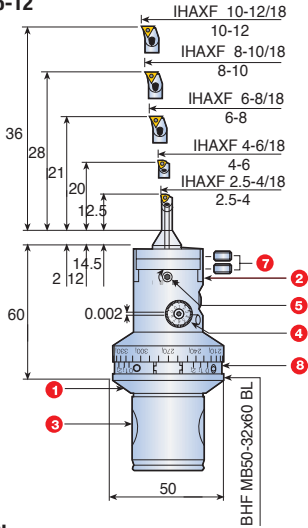

- 1 Body
- 2 Tool slide
- 3 Expanding pin
- 4 Graduated dial
- 5 Slide locking screw
- 6 Coolant nozzle
- 7 Boring bar locking screws
- 8 Balancing rings



BHF MB50-50x68 BL Diameter range: 6-12

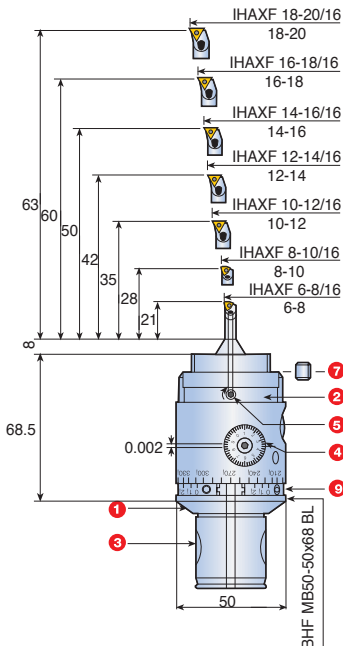

- 1 Body
- 2 Tool slide
- 3 Expanding pin
- 4 Graduated dial
- 5 Slide locking screw
- 6 Coolant nozzle
- 7 Boring bar locking screws
- 8 Oiling nipple
- 9 Balancing rings

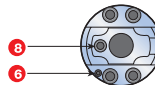

Fine boring head range: 2 μ m direct diametric adjustment

BHF MB50-50x60
Diameter range: 6-111

2 μ m

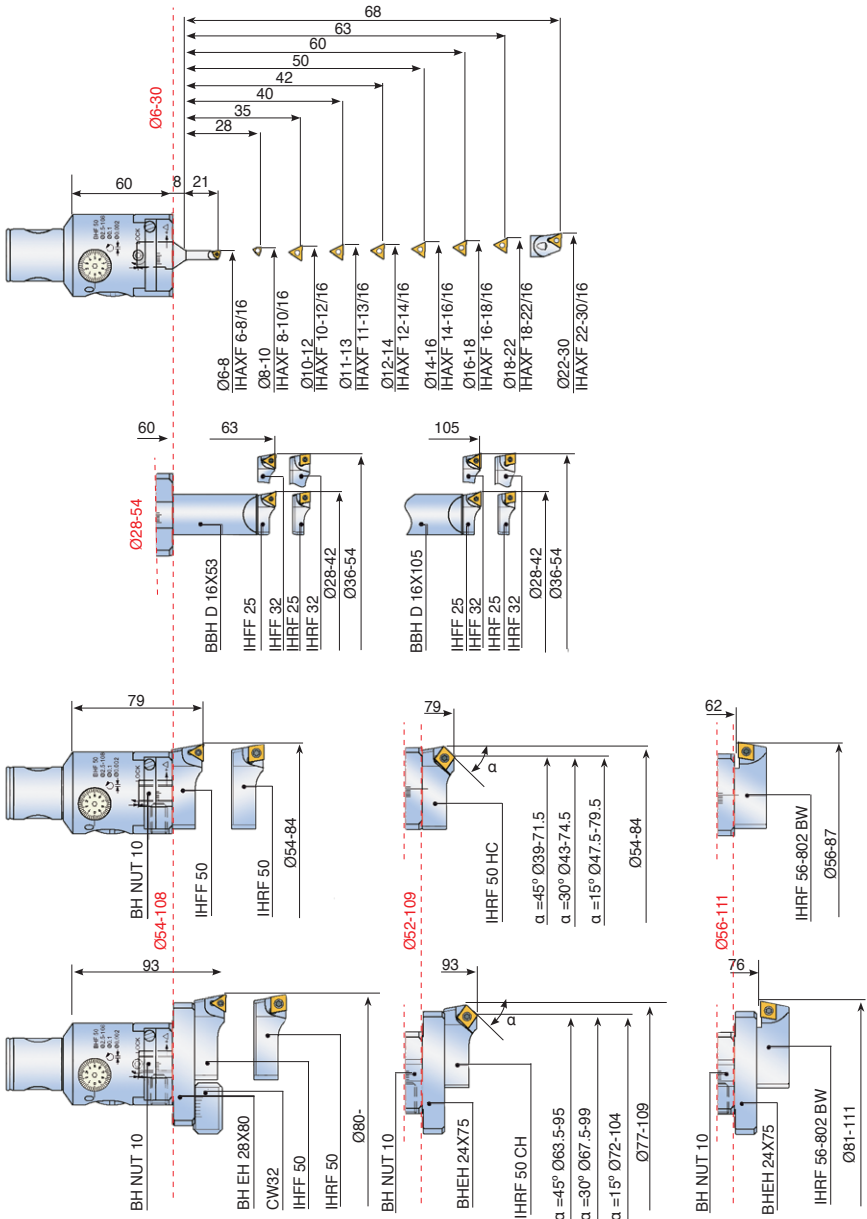

Fine boring head range: 2 μ m direct diametric adjustment

2 μ m

BHF MB50-63x87
BHF MB63-63x87
 Diameter range: 2.5-160

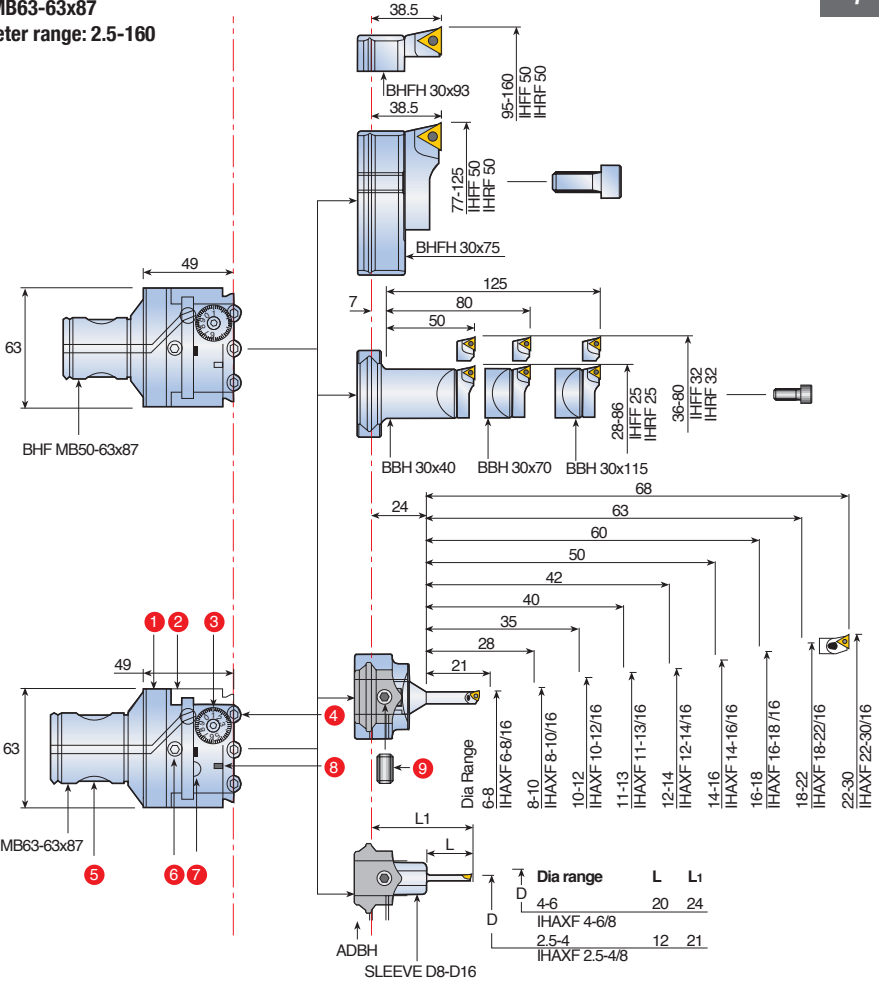

- 1 Body
- 2 Tool slide
- 3 Graduated dial
- 4 Toolholder locking screw
- 5 Expanding pin
- 6 Slide locking screw
- 7 Coolant nozzle
- 8 Oiling nipple
- 9 Toolholder locking screw

Fine boring head range: 2 μ m direct diametric adjustment

BHF MB50-80x94
BHF MB80-80x94
 Diameter range: 2.5-220

2 μ m

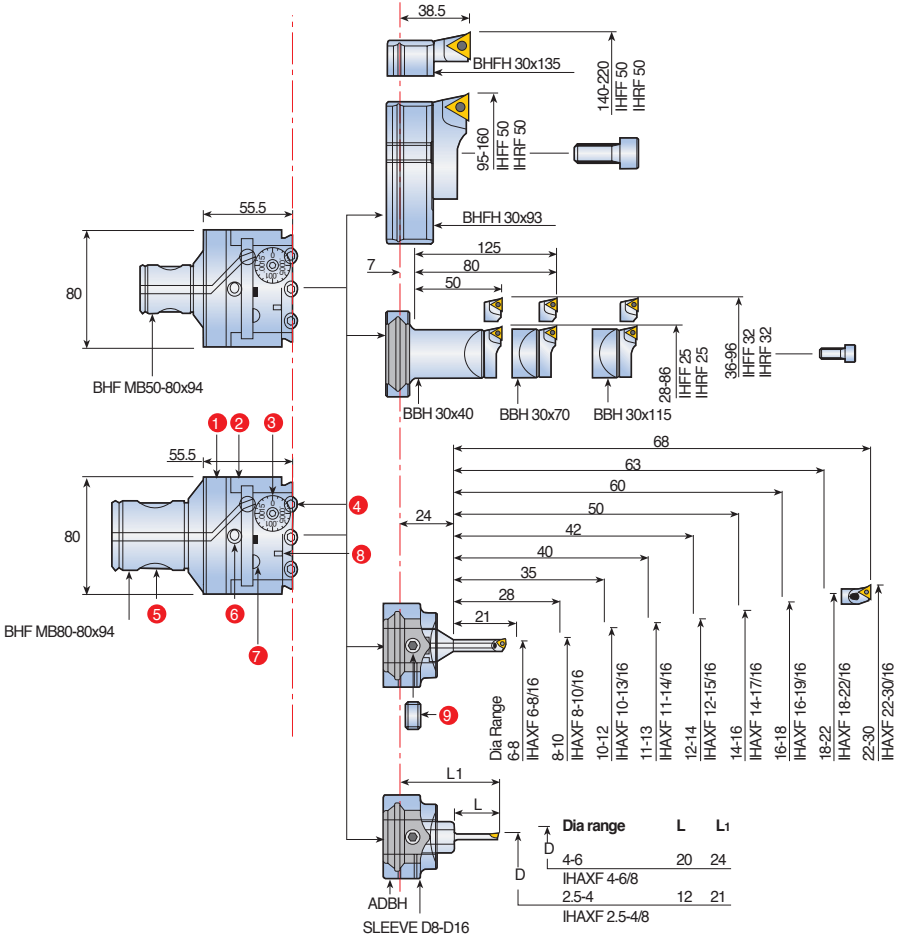

- 1 Body
- 2 Tool slide
- 3 Graduated dial
- 4 Toolholder locking screw
- 5 Expanding pin
- 6 Slide locking screw
- 7 Coolant nozzle
- 8 Oiling nipple
- 9 Toolholder locking screw

Fine boring head range: 2 μ m direct diametric adjustment

2 μ m

BHF MB80-125x114
Diameter range:36-500

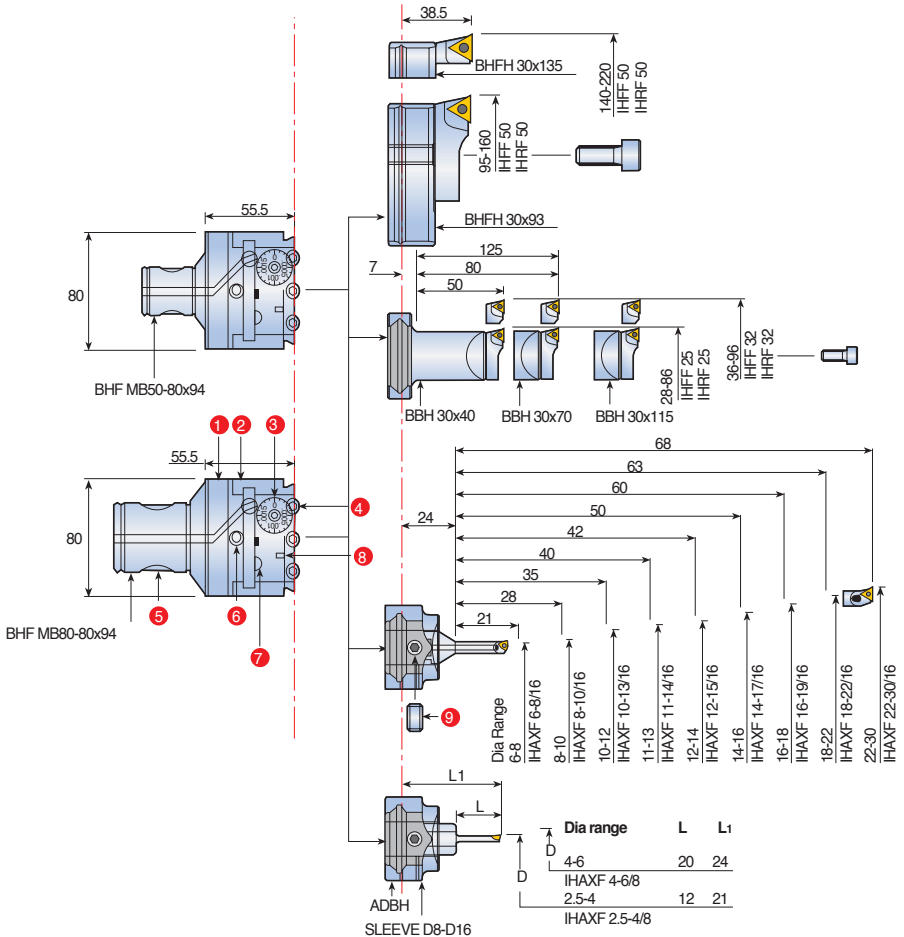

- ① Body
- ② Tool slide
- ③ Graduated dial
- ④ Toolholder locking screw
- ⑤ Expanding pin
- ⑥ Slide locking screw
- ⑦ Coolant nozzle
- ⑧ Oiling nipple

8mm boring bar for 2.5-12mm fine boring heads

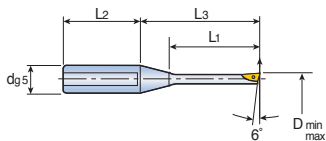

Fig.1

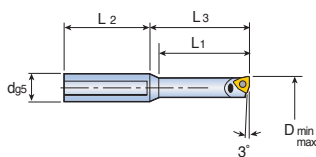

Fig.2

Designation	Dimension (mm)						Spare parts			Fig.
	D _{min}	D _{max}	L ₁	L ₃	L ₂	d	Insert	Screw	Key	
IHAXF2.5-4/8⁽¹⁾	2.5	4	12.5	21	22	8	Solid	-	-	1
4-6/8⁽¹⁾	4	6	20.0	24	24	8	Solid	-	-	1
6-8/8	6	8	21.0	21	16	8	WCGT 0201	SR 14-299	T-6/5	2
8-10/8	8	10	-	28	16	8	WCGT 0201	SR 14-299	T-6/5	2
10-12/8	10	12	-	36	16	8	TPGX 0902	SR 14-299	T-6/5	2

• ⁽¹⁾ Brazed tool

IHAXF

Fine Boring Bar

16mm bars for 6-30mm fine boring heads

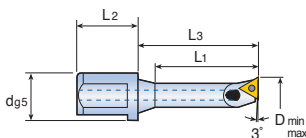

Designation	Dimension (mm)						Spare parts		
	D _{min}	D _{max}	L ₁	L ₃	L ₂	d	Insert	Screw	Key
IHAXF6-8/16	6	8	21.0	29	22	16	WCGT 0201	SR 14-299	T-6/5
8-10/16	8	10	28.0	36	22	16	WCGT 0201	SR 14-299	T-6/5
10-12/16	10	12	35.0	43	22	16	TPGX 0902	SO 25061I	T-8/5
11-13/16	11	13	40.0	48	22	16	TPGX 0902	SO 25061I	T-8/5
12-14/16	12	14	42.0	48	22	16	TPGX 0902	SO 25061I	T-8/5
14-16/16	14	16	50.0	52	22	16	TPGX 0902	SO 25061I	T-8/5
16-18/16	16	18	50.0	58	22	16	TPGX 0902	SO 25061I	T-8/5
18-22/16	18	22	60.0	63	22	16	TPGX 0902	SO 25061I	T-8/5
22-30/16	22	30	60.0	68	22	16	TPGX 0902	SO 25061I	T-8/5



SLEEVE

Fine Boring Bar

Reducers for fine boring heads

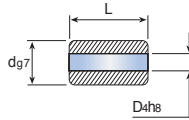

Designation	Dimension (mm)		
	d	D4	L
SLEEVE D8-D16	16	8	23

BBH D16

Fine Boring Bar

Extension for BHF 50x50x63

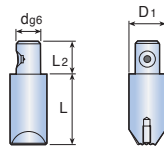

Designation	Dimension (mm)				kg
	D1	L	d	L2	
BBH D16x53	25	53	16	21.5	0.3

Vibration damping for fine boring bars – Heavy metal shank

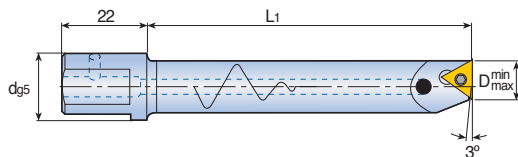

Designation	Dimension (mm)				Spare parts		
	D _{min}	D _{max}	L ₁	d	Insert	Screw	Key
IHAXF6-9-AVI	6	9	36	16	WCGT 0201..	SR 14-299	T-6/5
8-10-AVI	8	10	48	16	WCGT 0201..	SR 14-299	T-6/5
10-12-AVI	10	12	60	16	TPGX 0902..	SO 250611	T-8/5
12-14-AVI	12	14	72	16	TPGX 0902..	SO 250611	T-8/5
14-16-AVI	14	16	84	16	TPGX 0902..	SO 250611	T-8/5
16-18-AVI	16	18	96	16	TPGX 0902..	SO 250611	T-8/5

• Note: Not recommended to be used on balanceable BHF-BL fine boring heads.

IHAXF-E

Fine Boring Bar

Vibration damping for fine boring bars – Carbide shank

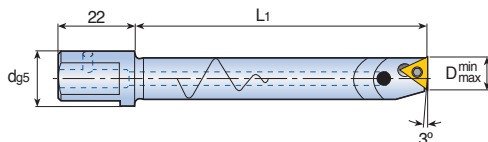

Designation	Dimension (mm)				Spare parts		
	D _{min}	D _{max}	L ₁	d	Insert	Screw	Key
IHAXF6-8-E	6	8	45	16	WCGT 0201..	SR 14-299	T-6/5
8-10-E	8	10	60	16	WCGT 0201..	SR 14-299	T-6/5
10-12-E	10	12	75	16	TPGX 0902..	SO 250611	T-8/5
12-14-E	12	14	90	16	TPGX 0902..	SO 250611	T-8/5
14-16-E	14	16	105	16	TPGX 0902..	SO 250611	T-8/5
16-18-E	16	18	120	16	TPGX 0902..	SO 250611	T-8/5

• Note: Not recommended to be used on balanceable BHF-BL fine boring heads.



Insert holders for mounting on the MB fine boring heads

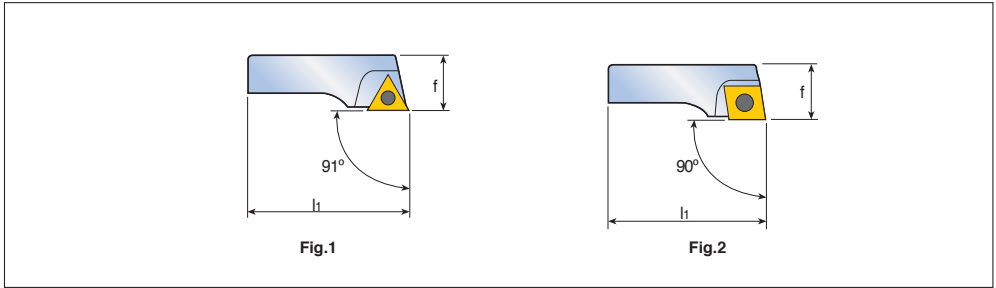

Designation	Dimension (mm)				Spare parts			Fig.	
	d _{min}	d _{max}	f	l ₁	Insert	Insert screw	Torx key		
IHFF 25	28	40	10.0	26.5	TPGX 0902...	SO 250611	T8/5	1	
	32	53	11.5	34.5	TPGX 0902...	SO 250611	T8/5	1	
	40	66	14.0	44.0	TPGX 1103...	SO 300811	T8/5	1	
	50	86	19.0	52.0	TPGX 1103...	SO 300811	T8/5	1	
IHRF 16	18	24	8.0	17	CCGT 0602..	SR 14-548	T-7/5	2	
	20	22	30	8.5	21.0	CCGT 0602..	SR 14-548	T-7/5	2
	25	28	40	10.0	26.5	CCGT 0602..	SR 14-548	T-7/5	2
	32	35	53	11.5	34.5	CCGT 0602..	TS 400971	T-7/5	2
	40	48	66	14.0	44.0	CCGT 09T3...	TS 400971	T-15/5	2
	50	54	86	19.0	52.0	CCGT 09T3...	TS 400971	T-15/5	2

IHWF

Fine Boring Insert Holders

Insert holders for mounting on the MB fine boring heads

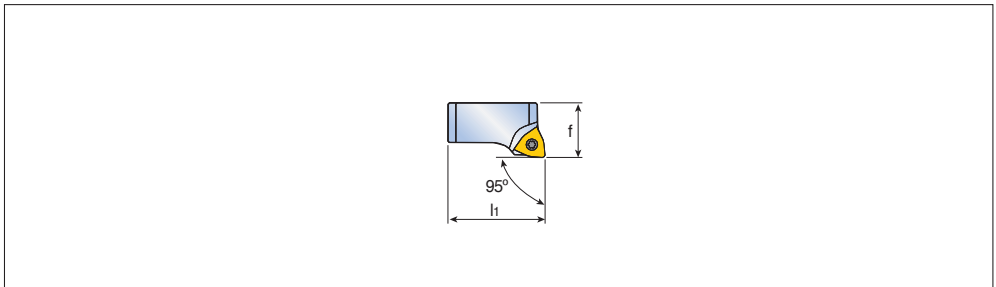

Designation	Dimension (mm)				Spare parts		
	d _{min}	d _{max}	f	l ₁	Insert	Insert screw	Torx key
IHWF 14E	14.5	18	8.0	14.0	WCGT 0201...	SR 14-299	T6/5



Slide extensions for fine boring holders

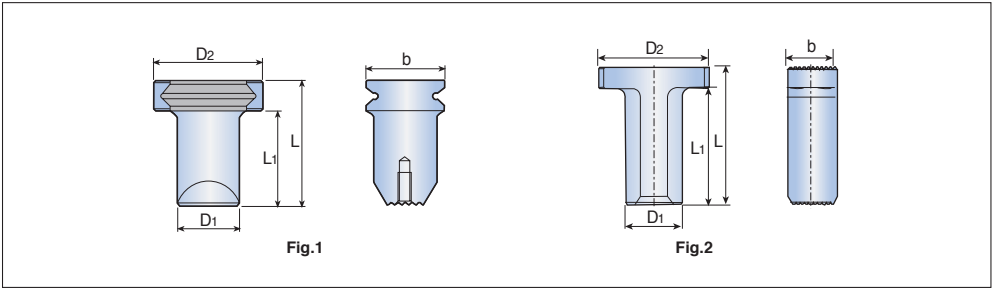

Designation	Dimension (mm)					Kg	Fig.
	D1	L1	L	D2	b		
BBH 30x40	25	40	52.5	43	30.5	0.3	1
30x70	25	70	82.5	43	30.5	0.4	1
30x115	27	115	127.5	43	30.5	0.7	1
40x69	32	69	86	56	40	0.7	1
40x114	32	114	131	56	40	1.0	1
40x189	38	189	206	56	40	2.0	1
63x78	32	66	78	63	28	0.7	2

Sleeve for fine boring holders

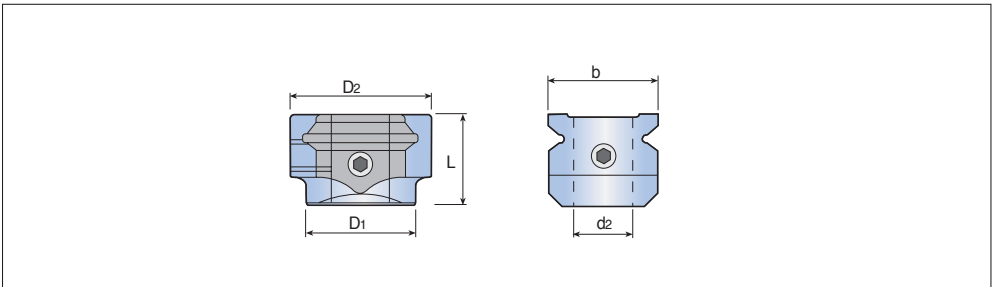

Designation	Dimension (mm)					Kg
	D1	D2	L	b	d2	
ADBH 30xD16	30	39	25	30.5	16	0.2

Slide for BHF & BHE fine boring holders

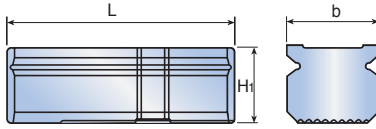

Fig.1

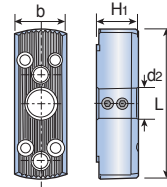

Fig.2

Designation	Dimension (mm)				Kg	Fig.
	H1	L	d2	b		
BHFH 30X75	25	75	-	30.5	0.4	1
30X93	25	93	-	30.5	0.5	1
30X135	25	135	-	30.5	0.7	1
40X133	40	133	-	40	1.5	1
40X200	40	200	-	40	2.4	1
40X300	40	300	-	40	3.5	1
40X400	40	400	-	40	4.6	1
BHEH 24X75	14.5	75	-	24	0.2	2
28X80	22.5	80	16	28	0.3	2
28X108	22.5	108	-	28	0.5	2
28X148	22.5	148	-	28	0.6	2

CW32

Fine Boring Insert Holders & Slides

Counter balancing weight

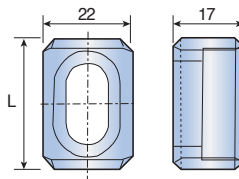

Designation	Dimension (mm)		Kg
	L		
CW 32	31.5		0.5

TCH

Fine Boring Heads

Fine boring aluminum body range: 200-500mm with MB connection

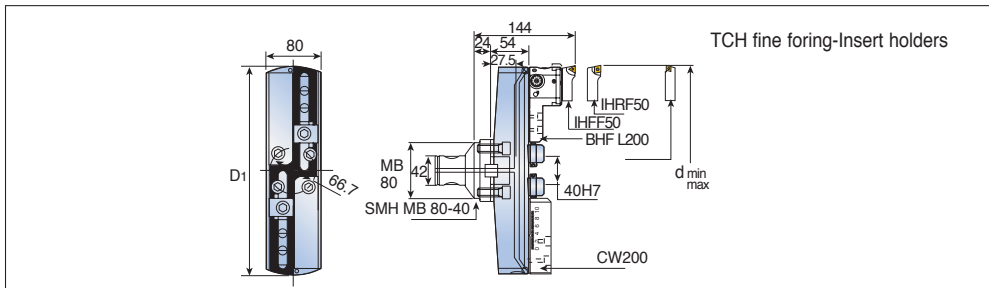

Designation	Dimension (mm)			Kg
	d _{min}	d _{max}	D1	
TCH 200	200	300	198	2.6
300	300	400	298	3.5
400	400	500	398	4.1

TCH A.L

Fine Boring Heads

Fine boring aluminum body range: 500-800mm with MB connection

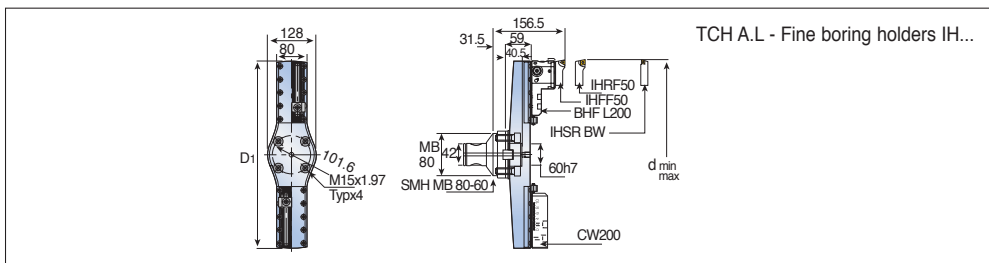

Designation	Dimension (mm)			Kg
	d _{min}	d _{max}	D1	
TCH A.L 500	500	600	494	7.5
600	600	700	594	9.0
700	700	800	694	10.5

Spare Parts



H68-H80



H32

BHF L200

Fine Boring Heads & Tool Holders

(200-800) Fine boring slide heads for TCH

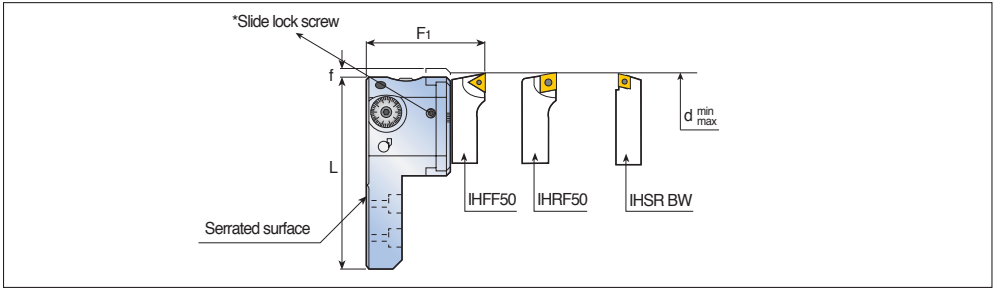

Designation	Dimension (mm)					Kg
	d _{min}	d _{max}	L	F ₁	f	
BHF L200	200	800	110	67	5	1.3

CW200

Fine Boring Heads & Tool Holders

Counter balancing weight for TCH

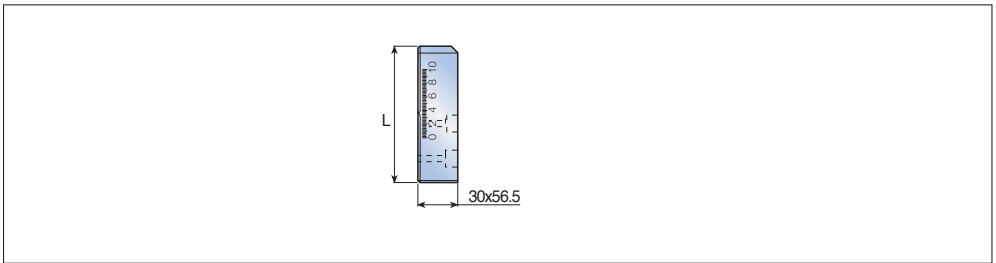

Designation	Dimension (mm)	Kg
	L	
CW 200	105	1.3



• Important: Loosen the slide lock screw* before making any slide adjustment.

KIT BHE MB50-50x80

Kits

Boring kit BHE MB50-50 ($\phi 6-110\text{mm}$) with fine boring head

10 μm
2 μm

Ø6-30
 8-110
 8
 21
 28
 40
 68
 Ø6-8
 IHAXF 6-8/16
 Ø8-12
 IHAXF 8-10/16
 Ø11-17
 IHAXF 11-13/16
 Ø16-23
 IHAXF 16-18/16
 Ø22-30
 IHAXF 22-30/16

Ø28-56
 8-110
 81
 8
 21
 28
 40
 68
 BH NUT 10
 BBH D16x53
 Ø28-44
 IHFF 25
 Ø36-56
 IHFF 32

Ø54-86
 8-110
 80
 8
 21
 28
 40
 68
 IHFF 50
 Ø54-86
 BHEH 24x75
 Ø80-110
 IHFF 50

Ø80-110
 8-110
 94
 8
 21
 28
 40
 68
 CW 32
 BHEH 24x75
 Ø92-110
 IHFF 50

Ø92-110
 8-110
 94
 8
 21
 28
 40
 68
 CW 32
 BHEH 24x75
 Ø92-110
 IHFF 50

1 BHE MB50-50x80
 1 IHFF 25
 1 IHFF 32
 1 IHFF 50
 1 IHAXF 6-8/16
 1 IHAXF 8-10/16
 1 IHAXF 11-13/16
 1 IHAXF 16-18/16
 1 IHAXF 22-30/16
 1 BH NUT 10
 1 CW 32
 1 IHAXF 22-30/16
 1 IHAXF 16-18/16
 1 IHAXF 22-30/16
 1 BH D16x53
 1 BHEH 24x75
 1 BH NUT 10
 1 CW 32

Designation	Dimension (mm)	
	MB d1	Boring range
KIT BHE MB50-50x80	50	6-110

• 10 μm direct diametric adjustment and 2 μm by a vernier scale

KIT BHE MB63-63x89

Kits

Boring kit BHE MB63-63 ($\phi 6-125\text{mm}$) with fine boring head

10 μm
2 μm

Ø6-30
 8-110
 8
 21
 28
 40
 68
 BHEH 28x80
 Ø6-8
 IHAXF 6-8/16
 Ø8-10
 IHAXF 8-10/16
 Ø11-13
 IHAXF 11-13/16
 Ø16-18
 IHAXF 16-18/16
 Ø22-30
 IHAXF 22-30/16

Ø40-90
 8-110
 85
 8
 21
 28
 40
 68
 BHH 63x78
 Ø40-56
 Ø54-74
 IHFF 32
 IHFF 50

Ø88-132
 8-110
 104
 8
 21
 28
 40
 68
 SFTP 50
 Ø88-132
 BHEH...
 CW 32
 SFTP 50

Ø115-200
 8-110
 125.5
 8
 21
 28
 40
 68
 Ø115-160 BHEH 28x108
 Ø155-200 BHEH 28x148

1 BHE MB63-63x89
 1 IHFF 32
 1 IHFF 50
 1 IHFF 6-8/16
 1 IHAXF 8-10/16
 1 IHAXF 11-13/16
 1 IHAXF 16-18/16
 1 IHAXF 22-30/16
 1 BH WASHER IH..50
 1 CW 32
 1 IHAXF 11-13/16
 1 IHAXF 16-18/16
 1 IHAXF 22-30/16
 1 BHEH 28x80
 1 BHEH 28x108
 1 BH NUT 10
 1 CW 32

Designation	Dimension (mm)	
	MB d1	Boring range
KIT BHE MB63-63x89	63	6-125

KIT BHE MB80-80x104

Kits

Boring kit BHE MB80-80 (ø6-200 mm) with fine boring head

10µm
2µm

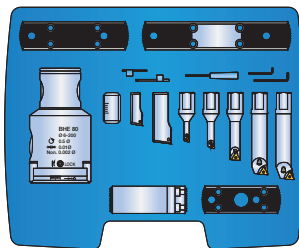
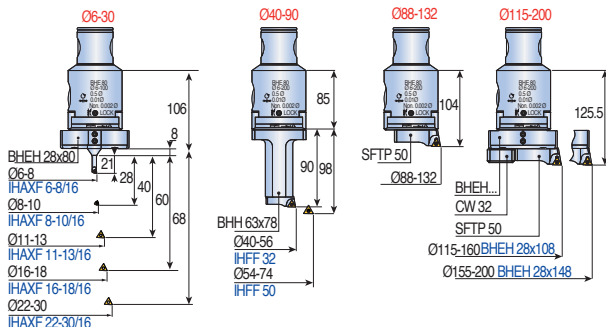

- 1 BHE MB80-80x104
- 1 IHFF 32
- 1 IHFF 50
- 1 IHFF 6-8/16
- 1 IHAXF 8-10/16
- 1 IHAXF 11-13/16
- 1 IHAXF 16-18/16
- 1 IBH 63x78
- 1 BHEH 28x80
- 1 BHEH 28x108
- 1 BH WASHER IH..50
- 1 CW 32

Designation	Dimension (mm)	
	MB d1	Boring range
KIT BHE MB80-80x104	80	6-200

KIT BHE MB32-32x53 H

Kits

Boring kit BHE MB32-32x53 H (ø2.5-12mm) with fine boring head

G2.5
12,000 RPM



10µm
2µm

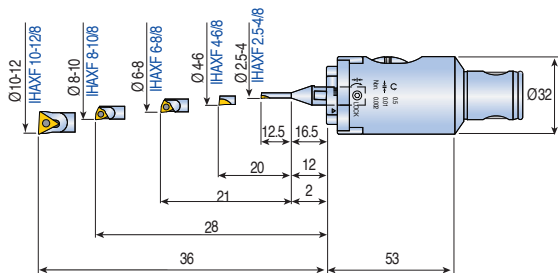

- Boring tools:
- 1 BHF MB32-32X53 H
 - 1 IHAXF 2.5-4/8
 - 1 IHAXF 4-6/8
 - 1 IHAXF 6-8/8
 - 1 IHAXF 8-10/8
 - 1 IHAXF 10-12/8
- Inserts:
- 5 TPGX 090202L
 - 2 WCGT 020102L

Designation	Dimension (mm)	
	MB d1	Boring range
KIT BHE MB32-32X53 H	32	2.5-12

KIT BHE MB50-50x60 H

Kits

Boring kit BHE MB50-50x60 H (ø6-22mm) with fine boring head

G2.5		10µm 2µm
12,000 RPM		

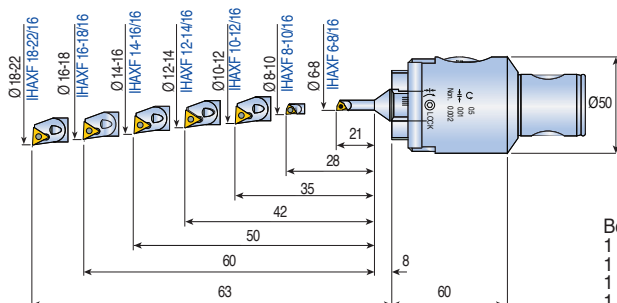

- Boring tools:**
- 1 BHE MB50-50x60 H
 - 1 IHAXF 6-8/16
 - 1 IHAXF 8-10/16
 - 1 IHAXF 10-12/16
 - 1 IHAXF 12-14/16
 - 1 IHAXF 14-16/16
 - 1 IHAXF 16-18/16
 - 1 IHAXF 18-22/16
- Inserts:**
- 5 TPGX 090202L
 - 2 WCGT 020102L

Designation	Dimension (mm)	
	MB d1	Boring range
KIT BHE MB50-50x60 H	50	6-22

• 10µm direct diametric adjustment and 2µm by a vernier scale

KIT BHF MB50-80/80-80

Kits

Kit BHF MB50-80 / Kit BHF MB80-80 6-220mm diameter range

2µm

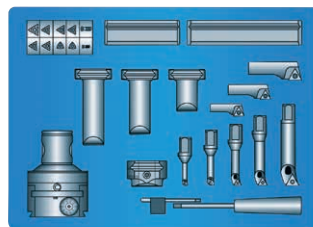
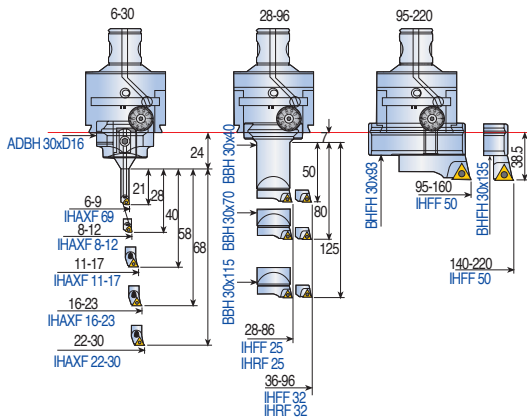

- 1 BHF MB.-80x94
- 1 IHAXF 6-8/16
- 1 IHAXF 8-10/16
- 1 IHAXF 11-13/16
- 1 IHAXF 16-18/16
- 1 IHAXF 22-30/16
- 1 ADBH 30xD16
- 1 BBH 30x40
- 1 BBH 30x70
- 1 BBH 30x115
- 1 BHFH 30x93
- 1 BHFH 30x135
- 1 IHFF 25
- 1 IHFF 32
- 1 IHFF 50
- 5 TPGX 090202L
- 1 TPGX 110302L
- 2 WCGT 020102L
- T-8/5
- T-6/5

Designation	Dimension (mm)	
	MB d1	Diameter range
KIT BHF MB50-80	50	6-220
MB80-80	80	6-220

KIT MOLD BH F/R 28-50

Kits

Kit mold MB25-32, 28-50mm diameter range kit composed of fine and rough boring heads

2µm

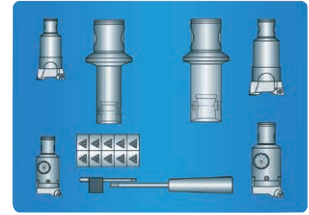
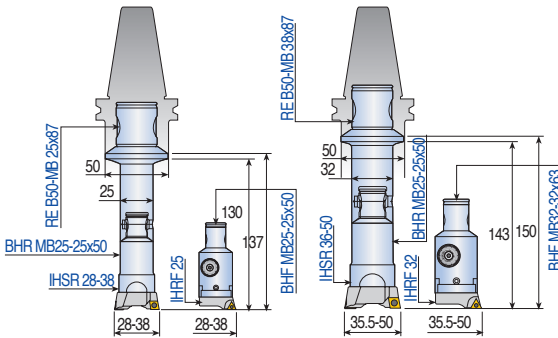

- 1 RE MB50-MB25X87
- 1 RE MB50-MB32X87
- 1 BHR MB25-25X50
- 1 BHR MB32-32X63
- 1 BHF MB25-25X50
- 2 IHSR 28-38
- 1 IHSR 36-50
- 1 IHFF 25
- 10 INSERTS
- 1 IHFF 32
- TPGX 090202L
- T-8/5

Designation	Dimension (mm)	
	MB d1	Diameter range
KIT MOLD BH F/R 28-50	25, 32	28-50

KIT BL BHF MB 50-32

Kits

Boring kit 2.5-12mm diameter range with BHF fine boring balanceable head

G2.5
20,000 RPM



2µm

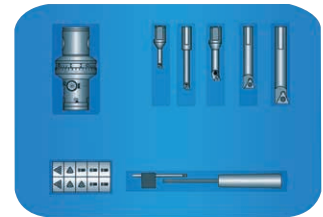
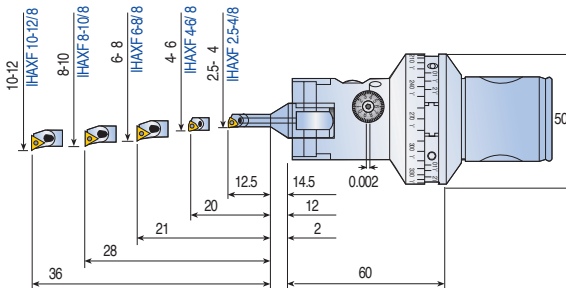

- 1 BHF MB50-32X60 BL
- 1 IHAXF 2.5-4/8
- 1 IHAXF 4-6/8
- 1 IHAXF 6-8/8
- 1 IHAXF 8-10/8
- 1 IHAXF 10-12/8
- 5 TPGX 090202L
- 2 WCGT 020102L

Designation	Dimension (mm)	
	MB d1	Diameter range
KIT BL BHF MB50-32	50	2.5-12

KIT BHF MB50-63/MB63-63

Kits

6-125mm diameter range

2µm

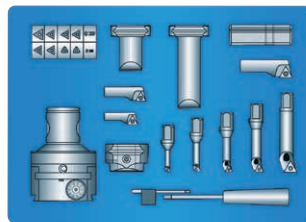
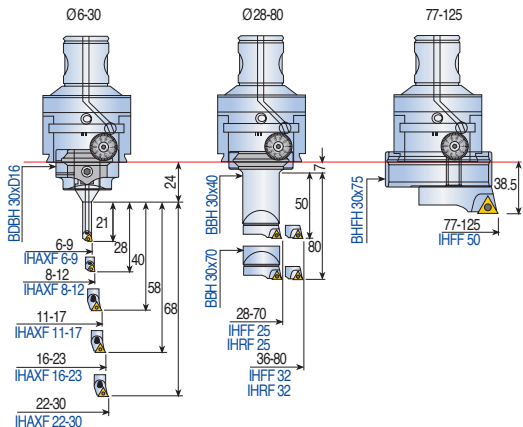

- 1 BHF MB...-63x87
- 1 IHAXF 6-8/16
- 1 IHAXF 8-10/16
- 1 IHAXF 11-13/16
- 1 IHAXF 16-18/16
- 1 IHAXF 22-30/16
- 1 ADBH 30xD16
- 1 BBH 30x40
- 1 BBH 30x70
- 1 BHFH 30x75
- 1 IHFF 25
- 1 IHFF 32
- 1 IHFF 50
- 5 TPGX 090202L
- 1 TPGX 110302L
- 2 WCGT 020102L
- T-8/5
- T-6/5

Designation	Dimension (mm)	
	MB d1	Diameter range
KIT BHF MB50-63	50	6-125
MB63-63	63	6-125

KIT MOLD BH F/R 18-28

Kits

Kit mold MB 16, 20, 18-28mm diameter range kit composed of fine and rough boring heads

2µm

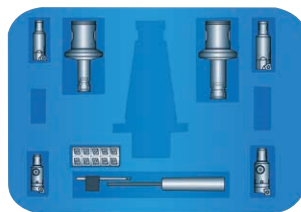
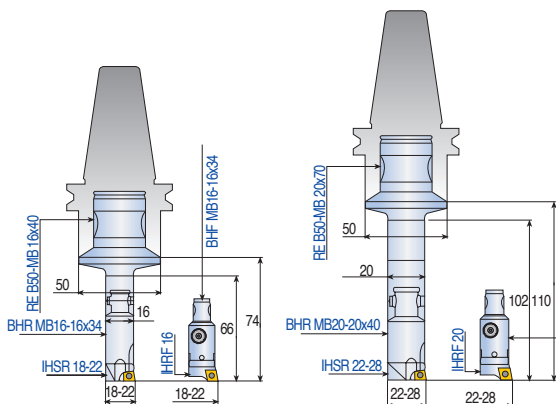

- 1 RE MB50-MB16x40
- 1 RE MB50-MB20x70
- 1 BHF MB16-16x34
- 1 BHF MB20-20x40
- 1 IHRF 16
- 1 IHRF 20
- 1 BHR MB16-16x34
- 1 BHR MB20-20x40
- 2 IHSR 18-22
- 2 IHSR 22-28
- 10 CCGT 060202L
- T-8/5
- T-6/5

Designation	Dimension (mm)	
	MB d1	Diameter range
KIT MOLD BH F/R 18-28	16,20	18-28

KIT BHFH MB80-125

Kits

Kit BHFH MB80-125 holder for BHF MB80-125x114,36-410mm diameter range

2µm

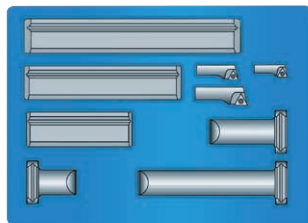
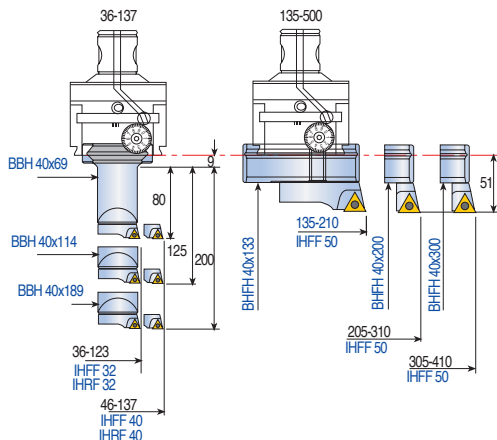

- 1 BBH 40x69
- 1 BBH 40x114
- 1 BBH 40x189
- 1 BHFH 40x133
- 1 BHFH 40x200
- 1 BHFH 40x300
- 1 IHFF 25
- 1 IHFF 40
- 1 IHFF 50

Designation	Dimension (mm)	
	MB d1	Diameter range
KIT BHFH MB80-125	50	6-20

• 10µm direct diametric adjustment and 2µm by a vernier scale

KIT IHAXF 6-30

Kits

Kit IHAXF 6-30,6-30mm diameter range

2µm

- 1 IHAXF 6-8/16
- 1 IHAXF 8-10/16
- 1 IHAXF 11-13/16
- 1 IHAXF 16-18/16
- 1 IHAXF 22-30/16
- 5 TPGX 090202L
- 3 WCGT 020102L
- T-8/5
- T-6/5

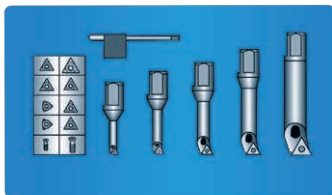

Designation	Dimension (mm)	
	Diameter range	
KIT IHAXF 6-30	6-30	

MB system clamp set

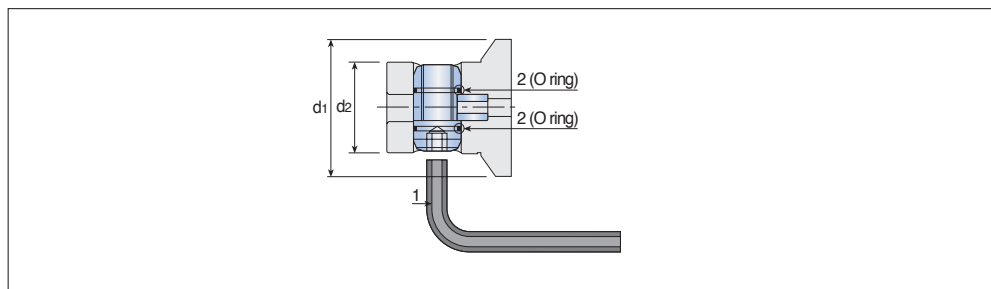

Designation	Dimension (mm)			
	d1	d2	1	2
MB CLAMP 16	16	10	2.5	-
20	20	13	3	-
25	25	16	3	-
32	32	20	4	ORM 0100-10
40	40	25	5	ORM 0130-10
50	50	32	6	ORM 0140-10
63-80	63-80	42	8	OR 2075

PLT

Spare Parts

Cover plate

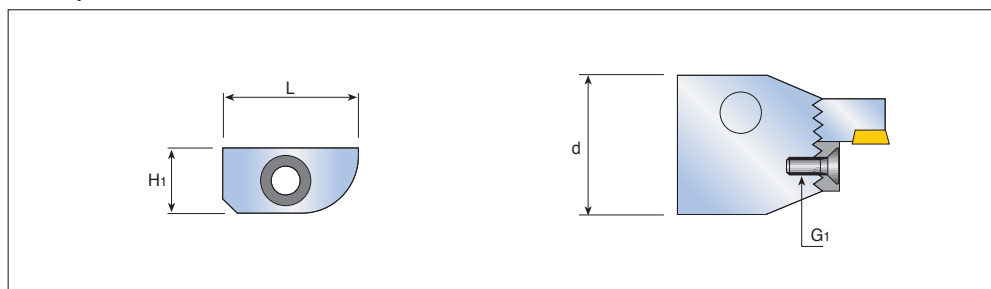

Designation	Dimension (mm)			
	d	H1	L	G1
PLT 16	16	7	14	M 3x8
20	20	8.5	17	M 4x10
25	25	10.2	21	M 4x16
32	32	13.9	28	M 5x20
40	40	17.4	35	M 6x25
50	50	21.4	47.5	M 8x25
63	63	26.4	62	M 10x30
80	80	33.9	82.5	M 12x35

- Protects the serrated faces when a single toolholder is being used.

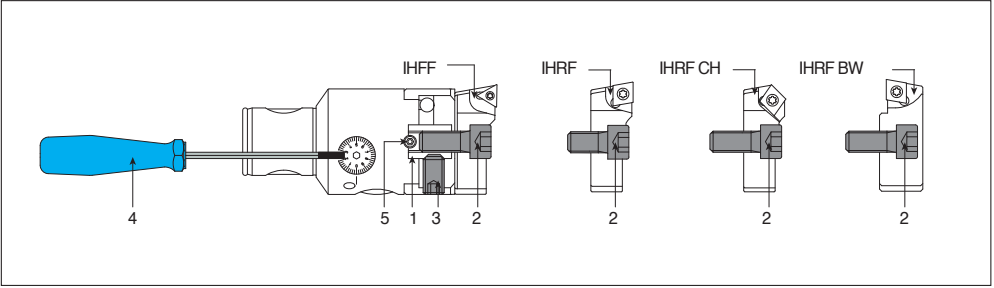

Designation	1	2	3	4	5
BHF...- 16...	-	SR M3x6 DIN 912	-	BH SR 1.5 HANDLE SR M3x4.5 DIN 913	
20...	-	SR M4x8 DIN 912	-	BH SR 1.5 HANDLE SR M3x4.5 DIN 913	
25...	-	SR M5x10 DIN 912	-	BH SR 2.0 HANDLE SR M4x4 DIN 913	
32...	-	SR M6x12 DIN 912	-	BH SR 2.0 HANDLE SR M4x5 DIN 913	
40...	-	SR M8x14 DIN 912	-	BH SR 2.5 HANDLE SR M5x6 DIN 913 SR	
50-60	BH NUT 10	SR M10x25 DIN 912 SR M10x16 DIN 913		BH SR 2.5 HANDLE SR M5x8 DIN 913	

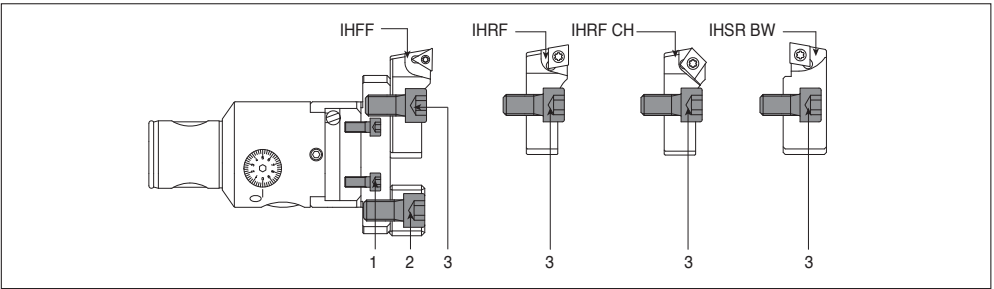

Designation	1	2	3
BHF...- 50...	SR M5x10 DIN 912	SR M10x20 DIN 912	SR M10x25 DIN 912

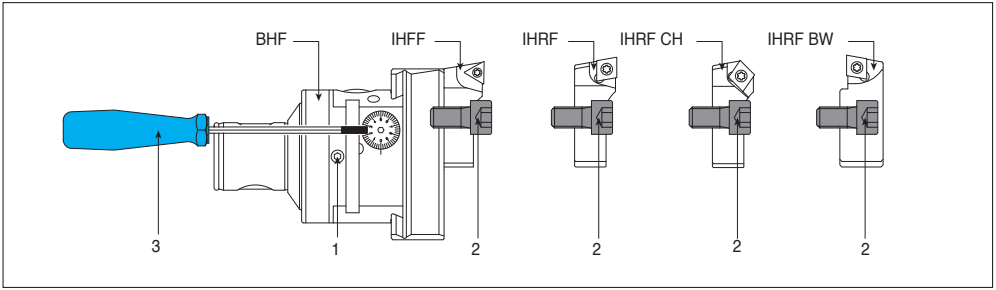

Designation	1	2	3
BHF...- 63...	SR M6x10 DIN 915	SR M10x25 DIN 912	BH SR 3.0 HANDLE
80...	SR M6x14 DIN 915	SR M10x25 DIN 912	BH SR 3.0 HANDLE
125...	SR M6x22 DIN 915	SR M10x25 DIN 912	BH SR 3.0 HANDLE

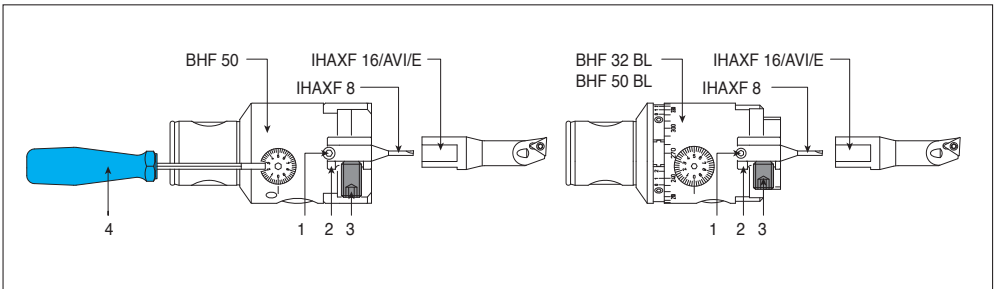

Designation	1	2	3	4
BHF...- 50...	SR M5x8 DIN 913	SLEEVE D 8-D16	SR M10x10 DIN 912	BH SR 2.5 HANDLE
32... BL	SR M4x5 DIN 913	-	SR M5x8 DIN 913 SR M5x12 DIN 913	BH SR 2.0 HANDLE
50... BL	SR M5x8 DIN 913	SLEEVE D 8-D16	SR M10x10 DIN 913 SR	BH SR 2.5 HANDLE

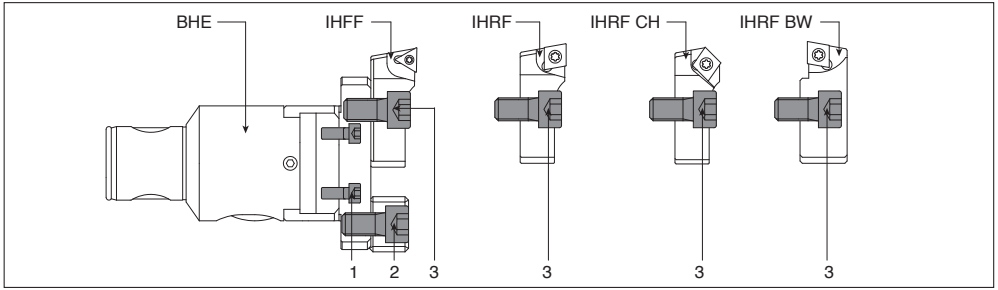

Designation	1	2	3
BHE MB50-50x80	SR M5x12 DIN 912	SR M10x20 DIN 912	SR M10x25 DIN 912
MB63-63x89	SR M5x25 DIN 912	SR M10x20 DIN 912	SR M10x25 DIN 912
MB80-80x104	SR M5x25 DIN 912	SR M10x20 DIN 912	SR M10x25 DIN 912

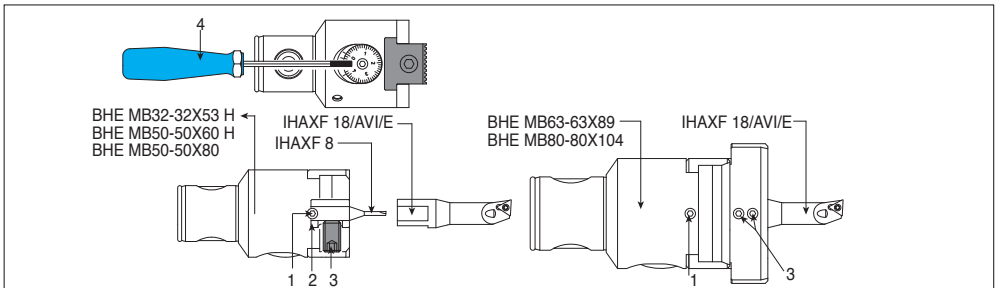

Designation	1	2	3	4
BHE MB32-32x53 H	SR M5x5 DIN 913	-	SR M5x8 DIN 913	BH SR 2.5 HANDLE
	SR M5x5 DIN 913	-	SR M5x12 DIN 913	BH SR 2.5 HANDLE
MB50-50x60 H	SR M6x8 DIN 913	SLEEVE D 8-D16	SR M10x10 DIN 913	BH SR 3.0 HANDLE
MB50-50x8	SR M6x8 DIN 913	-	SR M10x10 DIN 913	BH SR 3.0 HANDLE
MB63-63x89	SR M6x8 DIN 913	-	SR M6x6 DIN 913	BH SR 3.0 HANDLE
MB80-80x104	SR M6x12 DIN 913	-	SR M6x6 DIN 913	BH SR 3.0 HANDLE

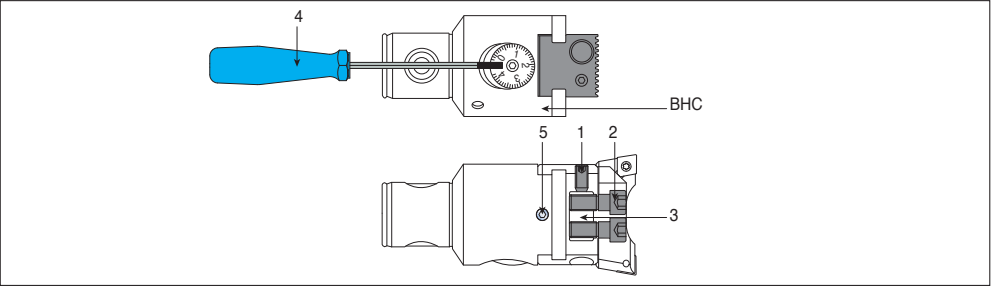

Designation	1	2	3	4	5
BHC MB25-25x57	SR M4x8 DIN 913	BH SR M4x11 DIN 912 PT	BH NUT-BHC MB25	BH SR 2.0 HANDLE	SR M4x5 DIN 913
MB32-32x71	SR M5x10 DIN 913	BH SR M5x12.5 DIN 912 PT	BH NUT-BHC MB32	BH SR 2.5 HANDLE	SR M5x5 DIN 913
MB40-40x90	SR M6x12 DIN 913	BH SR M6x16 DIN 912 PT	BH NUT-BHC MB40	BH SR 3.0 HANDLE	SR M6x6 DIN 913
MB50-50x87	SR M6x14 DIN 913	BH SR M8x20 DIN 912 PT	BH NUT-BHC MB50	BH SR 3.0 HANDLE	SR M6x8 DIN 913
MB63-63x109	SR M6x16 DIN 913	BH SR M10x26 DIN 912 PT	BH NUT-BHC MB63	BH SR 3.0 HANDLE	SR M6x8 DIN 913
MB80-80x130	SR M6x20 DIN 913	BH SR M12x30 DIN 912 PT	BH NUT-BHC MB80	BH SR 3.0 HANDLE	SR M6x12 DIN 913

BHR

Spare Parts

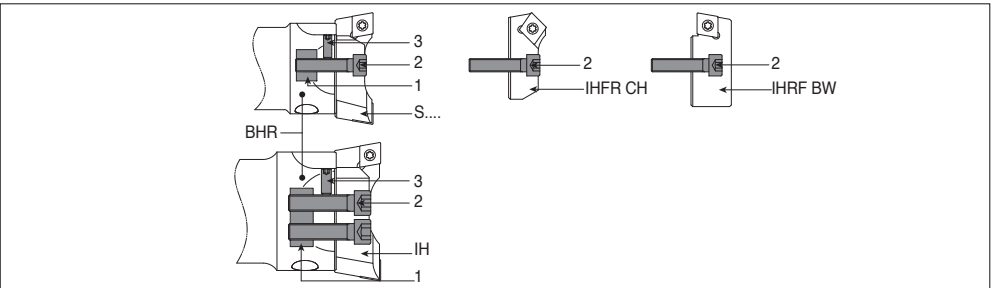

Designation	1	2	3
BHR MB16...16	BH NUT BHR MB16	SR M3x14 DIN 912	SR M3x4 DIN 913
MB20...20	BH NUT BHR MB20	SR M4x15 DIN 912	SR M3x5 DIN 913
MB25...25	BH NUT BHR MB25	SR M4x20 DIN 912	SR M3x8 DIN 913
MB32...32	BH NUT BHR MB32	SR M5x25 DIN 912	SR M4x12 DIN 913
MB40...50	BH NUT BHR MB40	SR M6x30 DIN 912	SR M5x14 DIN 913
MB50...50	BH NUT BHR MB50	SR M8x35 DIN 912	SR M5x12 DIN 913
MB50...63	BH NUT BHR MB63	SR M10x40 DIN 912	SR M6x16 DIN 913
MB63...63	BH NUT BHR MB63	SR M10x40 DIN 912	SR M6x16 DIN 913
MB80...80	BH NUT BHR MB80	SR M12x45 DIN 912	SR M8x25 DIN 913

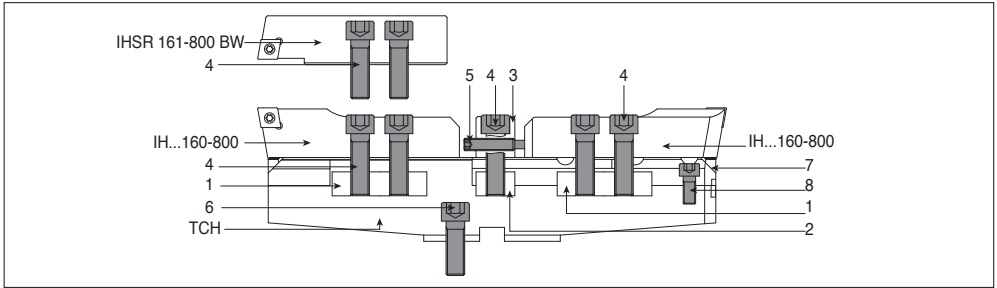

Designation	1	2	3	4
TCH 200-300-400	BH TCH NUT A	BH TCH NUT B	BH TCH NUT C	SR M12x40 DIN 912
500-600-700	BH TCH NUT A	BH TCH NUT B	BH TCH NUT C	SR M12x40 DIN 912

Designation	5	6	7	8
TCH 200-300	SR M8x40 DIN 915	SR M12x35 DIN 912	BH SERRATED PLATE 200-300	SR M8x25 DIN 912
400	SR M8x40 DIN 915	SR M12x35 DIN 912	BH SERRATED PLATE 400-700	SR M8x20 DIN 912
500-600-700	SR M8x40 DIN 915	SR M16x50 DIN 912	BH SERRATED PLATE 400-700	SR M8x25 DIN 912

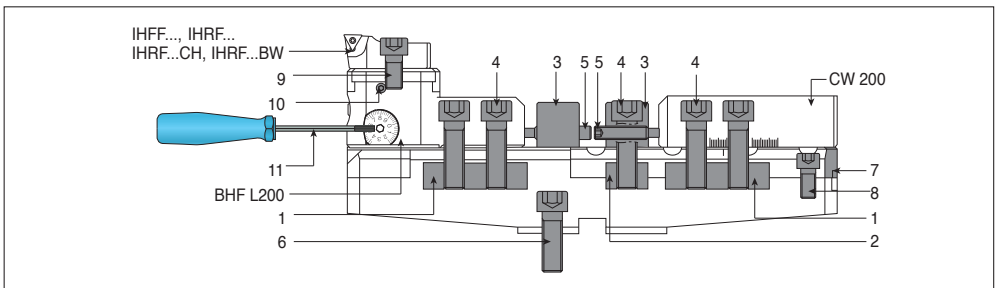

Designation	1	2	3	4	5
TCH 200-300-400	BH TCH NUT A	BH TCH NUT B	BH TCH NUT C	SR M12x40 DIN 912	SR M8x40 DIN 915
500-600-700	BH TCH NUT A	BH TCH NUT B	BH TCH NUT C	SR M12x40 DIN 912	SR M8x40 DIN 915

Designation	6	7	8	9	10	11
TCH 200-300	SR M12x35 DIN912	BH SERRATED PLATE 200-300	SR M8x25 DIN912	SR M10x20 DIN912	SR M6x8 DIN915	BH SR 3.0 HANDLE
400	SR M12x35 DIN912	BH SERRATED PLATE 400-700	SR M8x20 DIN912	SR M10x20 DIN912	SR M6x8 DIN915	BH SR 3.0 HANDLE
500-600-700	SR M16x50 DIN912	BH SERRATED PLATE 400-700	SR M8x25 DIN912	SR M10x20 DIN912	SR M6x8 DIN915	BH SR 3.0 HANDLE

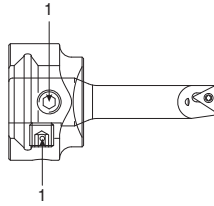

Designation	1
ADBH 30xD16	SR M45x8 DIN 913

BBH-D

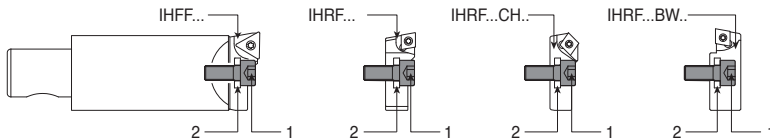

Designation	1	2
BBH D16x63	SR M5x12 DIN 912	WASHER DIN 125A M5
D16x105	SR M5x12 DIN 912	WASHER DIN 125A M5

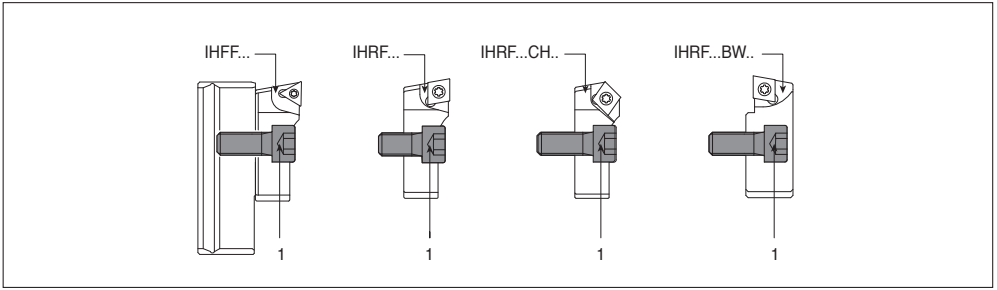

Designation	1
BHFH 30x75	SR M10x18 DIN 912
40x133	SR M10x18 DIN 912
30x93	SR M10x18 DIN 912
40x200	SR M10x25 DIN 912
30x135	SR M10x25 DIN 912
40x300	SR M10x25 DIN 912
40x400	SR M10x25 DIN 912

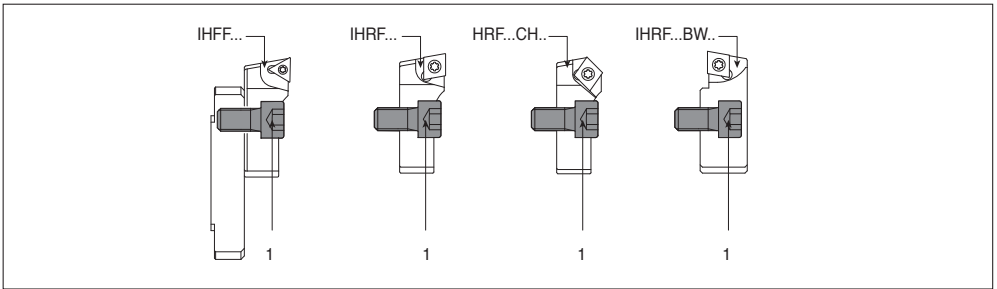

Designation	1
BHEH 24x75	SR M10x20 DIN 912
28x80	SR M10x25 DIN 912
28x108	SR M10x25 DIN 912
28x148	SR M10x25 DIN 912

Components for CC

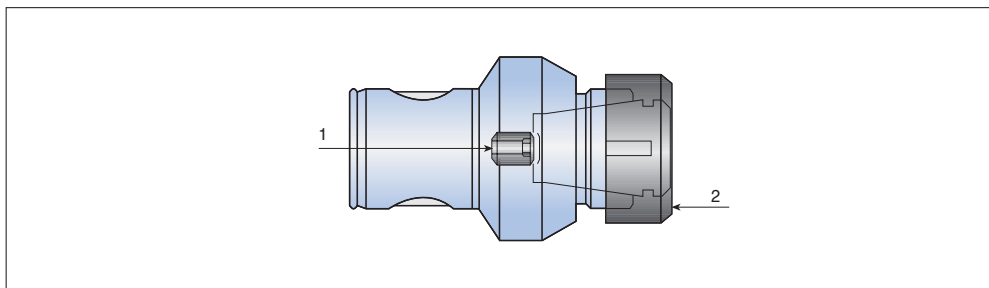

Designation	1	2	Wrench
CC MB16-ER11M	CC MB16 SCREW	NUT ER11 MINI	WRENCH ER11 MINI
MB20-ER16M	CC MB20 SCREW	NUT ER16 MINI	WRENCH ER16 MINI
MB25-ER20M	CC MB25 SCREW	NUT ER20 MINI	WRENCH ER20 MINI
MB32-ER25M	CC MB32 SCREW	NUT ER25 MINI	WRENCH ER25 MINI
MB40-ER25	CC MB40 SCREW	NUT ER25 TOP	WRENCH ER25
MB50-ER25	CC MB50 SCREW	NUT ER25 TOP	WRENCH ER25
MB50-ER32	CC MB50 SCREW	NUT ER32 TOP	WRENCH ER32
MB63-ER32	CC MB63 SCREW	NUT ER32 TOP	WRENCH ER32
MB63-ER40	CC MB63 SCREW	NUT ER40 TOP	WRENCH ER40

AMT MB...-MT

Spare Parts

Screw for shanks: Morse taper tang AMT

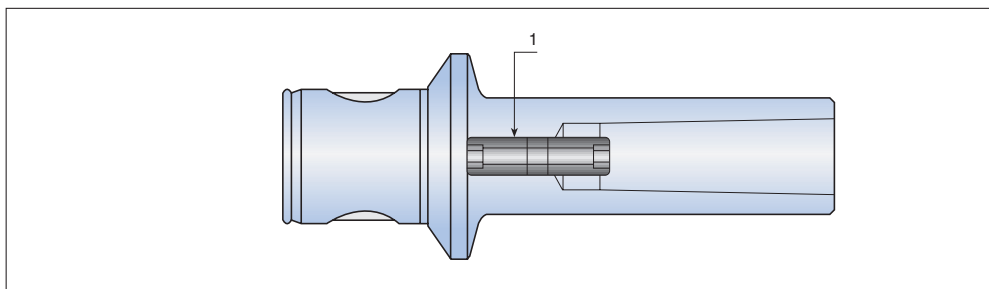

Designation	1
AMT MB50-MT2	AMT MT2-SCREW
MB50-MT3	AMT MT3-SCREW
MB63-MT3	AMT MT3-SCREW
MB63-MT4	AMT MT4-SCREW

Screw for shell mill holders SMH

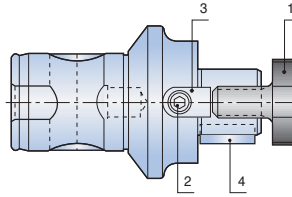

Designation	1	2	3	4
SMH MB40-22	M10 CLAMP SCREW SEM 22	DOG DRIVE SMH 22	KEY SMH 22	M4x10 SMH KEY SCREW
MB50-16	M 8 CLAMP SCREW SEM 16	DOG DRIVE SMH 16	KEY SMH 16	M3x 8 SMH KEY SCREW
MB50-22	M10 CLAMP SCREW SEM 22	DOG DRIVE SMH 22	KEY SMH 22	M4x10 SMH KEY SCREW
MB50-27	M12 CLAMP SCREW SEM 27	DOG DRIVE SMH 27	KEY SMH 27	M5x12 SMH KEY SCREW
MB50-32	M16 CLAMP SCREW SEM 32	DOG DRIVE SMH 32	KEY SMH 32	M6x16 SMH KEY SCREW
MB63-27	M12 CLAMP SCREW SEM 27	DOG DRIVE SMH 27	KEY SMH 27	M5x12 SMH KEY SCREW
MB63-32	M16 CLAMP SCREW SEM 32	DOG DRIVE SMH 32	KEY SMH 32	M6x16 SMH KEY SCREW
MB80-32	M16 CLAMP SCREW SEM 32	DOG DRIVE SMH 32	KEY SMH 32	M6x16 SMH KEY SCREW
MB80-40	M20 CLAMP SCREW SEM 40	DOG DRIVE SMH 40	KEY SMH 40	M6x18 SMH KEY SCREW

NUT ER ... TOP

ER - Top™ clamping nut

DIN 6499

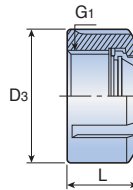

Designation	Dimension (mm)		
	D3	L	G1
NUT ER16 TOP	28	17	M22x1.5
ER20 TOP	34	19	M25x1.5
ER25 TOP	42	20	M32x1.5
ER32 TOP	50	22	M40x1.5
ER40 TOP	63	25	M50x1.5

Cutting Conditions

BHR rough boring heads

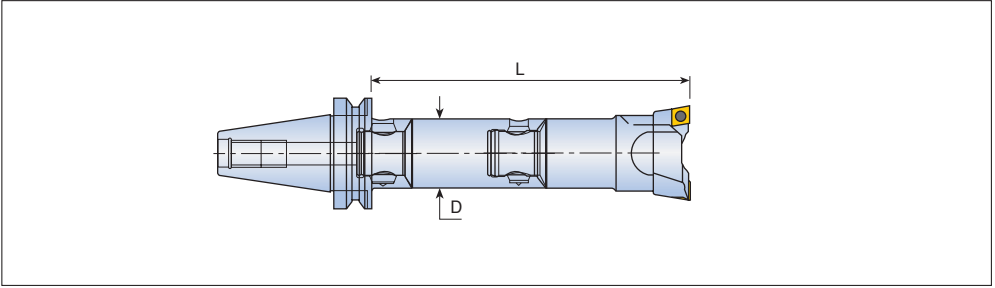

Cutting depth

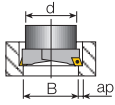

It's advisable to start with B hole boring bar diameter d

B Working range	ap (mm) Steel	ap (mm) Cast iron, Aluminum
18-28	1.5-2	2-2.5
28-50	2-3	2.5-3.5
50-68	3-4	3.5-5
68-200	4-5	5-7
200-500	5-6	6-8

• In case of a single or a stepped boring cutter configuration, only half the feed should be applied

Fine boring heads

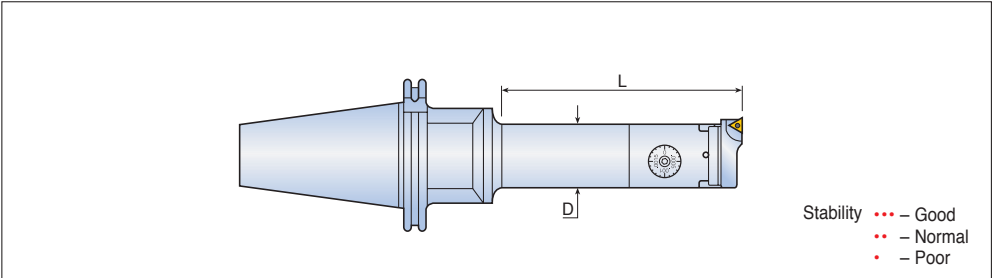

Stability ... – Good
 .. – Normal
 . – Poor

Material	L/D	Stability	Cutting speed (Vc=m/min)	Feed f=mm/rev		Cutting depth (ap)
				Insert radius		
				R=0.2	R=0.4	
Carbon steel HB≤200	L/D=2.5	...	200-300	0.05-0.08	0.08-0.10	
	L/D=4	..	160-250	0.05-0.08	0.08-0.10	
	L/D=6.3	.	70-100	0.05-0.08	-	
Carbon steel HB>200	L/D=2.5	...	160-250	0.05-0.08	0.08-0.10	
	L/D=4	..	150-200	0.05-0.08	0.08-0.10	
	L/D=6.3	.	70-100	0.05-0.08	-	
Stainless steel	L/D=2.5	...	150-200	0.05-0.08	0.08-0.10	
	L/D=4	..	120-180	0.08-0.10	0.08-0.10	
	L/D=6.3	.	70-80	0.05-0.08	0.08-0.10	
Alloyed steel HB 480-550	L/D=2.5	...	120-160	0.05-0.08	0.08-0.10	
	L/D=4	..	100-140	0.05-0.08	0.08-0.10	
	L/D=6.3	.	70-100	0.05-0.08	-	
Cast iron	L/D=2.5	...	120-160	0.05-0.08	0.08-0.10	
	L/D=4	..	100-140	0.05-0.08	0.08-0.10	
	L/D=6.3	.	70-100	0.05-0.08	-	
Aluminum	L/D=2.5	...	300-400	0.05-0.08	0.08-0.10	
	L/D=4	..	250-350	0.05-0.08	0.08-0.10	
	L/D=6.3	.	100-150	0.05-0.08	-	

Cutting Conditions

Stability ••• – Good
•• – Normal
• – Poor

Boring operations with BHC combi rough and fine

Material	L/D	Stability	Cutting speed (Vc=m/min)	Feed f=mm/rev		Cutting depth (mm)			
				Insert radius					
				R=0.2	R=0.4				
Carbon steel HB<200	L/D=2.5	•••	160-250	0.1-0.2	0.1-0.2	0.15-0.3	1.5	2	2.5
	L/D=4	••	120-180	0.1-0.2	0.1-0.2				
	L/D=6.3	•	70-100	* 0.1-0.15	0.1-0.2				
Carbon steel HB>200	L/D=2.5	•••	140-200	0.1-0.2	0.1-0.2	0.15-0.3	1.5	2	2.5
	L/D=4	••	100-160	0.1-0.2	0.1-0.2				
	L/D=6.3	•	70-100	* 0.1-0.15	0.1-0.2				
Stainless steel AISI 304-316	L/D=2.5	•••	100-140	0.1-0.2	0.1-0.2	0.15-0.3	1.5	2	2.5
	L/D=4	••	80-110	0.1-0.2	0.1-0.2				
	L/D=6.3	•	60-90	* 0.1-0.15	0.1-0.2				
Cast iron	L/D=2.5	•••	120-160	0.1-0.2	0.1-0.2	0.15-0.3	2	2.5	3
	L/D=4	••	90-120	0.1-0.2	0.1-0.2				
	L/D=6.3	•	60-90	* 0.1-0.15	0.1-0.2				
Aluminum	L/D=2.5	•••	250-350	0.1-0.2	0.1-0.2	0.15-0.3	2	2.5	3
	L/D=4	••	160-250	0.1-0.2	0.1-0.2				
	L/D=6.3	•	100-150	* 0.1-0.15	0.1-0.2				

* Only for finishing Inserts.

** Use inserts with the same corner radii for both roughing and finishing inserts.

VC Cutting speed (m/min)
D Diameter of workpiece (m/min)
n Number of revolutions / min' (rev./min)
Vf Feed rate (mm/min.)
Fn Feed (mm/rev)
 π 3.14

$$VC = \frac{\pi \cdot D \cdot n}{1000}$$

$$n = \frac{VC \cdot 1000}{\pi \cdot D}$$

$$Vf = n \cdot fn$$

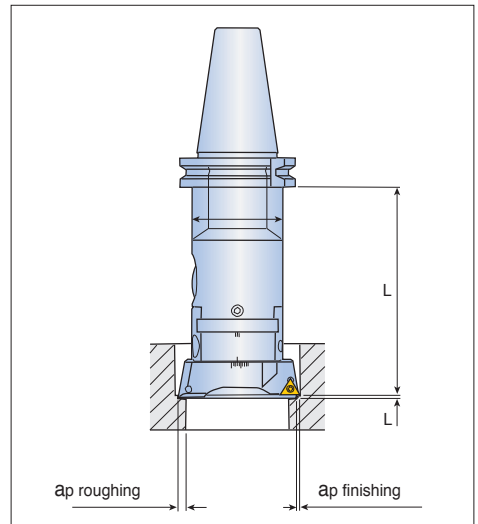

BHR Rough Boring Cutting Data

Stability *** – Good
** – Normal
* – Poor

ap(mm), R(radius), Vc(m/min), f(mm/rev)

ISO	Workpiece material	Hardness HB	Overhang L/D	Boring range						
				D18-28		D28-50		D50-68		
				ap (mm)	0.5-1.2	1.2-2.5	0.8-1.5	1.5-2.5	0.8-1.5	1.5-3.0
R (Radius)	0.2	0.4	0.2-0.4	0.4	0.2-0.4	0.4-0.8				
P	Carbon steel	HB<200	2.5 ***	Vc	150-180	120-150	160-200	140-170	160-200	140-180
				f	0.1-0.2	0.08-0.2	0.15-0.2	0.1-0.175	0.15-0.25	0.08-0.2
			4 ***	Vc	140-160	100-140	160-180	120-150	160-180	120-150
				f	0.1-0.18	0.08-0.15	0.1-0.12	0.08-0.1	0.1-0.12	0.08-0.1
			6.3 ***	Vc	60-80	40-60	60-90	50-60	70-90	50-70
				f	0.06-0.12	0.06-0.1	0.06-0.12	0.06-0.1	0.06-0.1	0.06-0.1
	Carbon steel	HB>200	2.5 ***	Vc	130-160	100-130	140-180	120-160	140-180	120-160
				f	0.08-0.15	0.08-0.12	0.08-0.2	0.06-0.12	0.08-0.25	0.08-0.18
			4 ***	Vc	110-140	80-110	100-140	80-120	100-140	80-120
				f	0.08-0.12	0.08-0.1	0.08-0.15	0.06-0.15	0.08-0.2	0.06-0.15
			6.3 ***	Vc	70-90	60-70	80-100	60-80	80-100	60-80
				f	0.08-0.1	0.06-0.08	0.06-0.1	0.06-0.08	0.08-0.15	0.06-0.1

ISO	Workpiece material	Hardness HB	Overhang L/D	Boring range						
				D68-120		D120-200		D200-500		
				ap (mm)	0.8-1.5	1.5-3.5	0.8-2.0	2.0-3.5	0.8-1.5	2.0-4.0
R (Radius)	0.2-0.4	0.4-0.8	0.2-0.4	0.4-0.8	0.2-0.4	0.4-0.8				
P	Carbon steel	HB<200	2.5 ***	Vc	160-220	150-180	180-250	160-200	220-280	200-220
				f	0.15-0.25	0.08-0.2	0.15-0.3	0.1-0.2	0.15-0.3	0.1-0.15
			4 ***	Vc	140-180	120-150	160-200	140-180	N.R.	N.R.
				f	0.08-0.2	0.08-0.15	0.1-0.2	0.08-0.15		
			6.3 ***	Vc	70-100	50-70	N.R.	N.R.	N.R.	N.R.
				f	0.06-0.1	0.06-0.1				
	Carbon steel	HB>200	2.5 ***	Vc	140-180	120-160	150-170	100-140	100-140	80-120
				f	0.15-0.3	0.12-0.2	0.15-0.25	0.1-0.2	0.15-0.3	0.1-0.2
			4 ***	Vc	120-150	100-140	100-130	80-110	N.R.	N.R.
				f	0.1-0.2	0.1-0.18	0.08-0.2	0.08-0.12		
			6.3 ***	Vc	80-100	60-80	N.R.	N.R.	N.R.	N.R.
				f	0.08-0.12	0.08-0.12				

- N.R. = Not recommended
- In case of a single or a stepped boring cutter configuration, only half the feed should be applied

BHR Rough Boring Cutting Data

Stability ••• – Good
•• – Normal
• – Poor

ap(mm), R(radius), Vc(m/min), f(mm/rev)

ISO	Workpiece material	Hardness HB	Overhang L/D	Boring range D18-28		Boring range D28-50		Boring range D50-68		
				ap (mm)	0.5-1.0	1.0-1.8	0.5-1.0	1.0-1.8	0.5-1.2	1.2-2.0
				R (Radius)	0.2	0.4	0.2-0.4	0.4	0.2-0.4	0.4-0.8
P	Alloyed steel	HB<200	2.5 •••	Vc	140-160	90-120	150-180	100-130	160-200	140-180
				f	0.08-0.18	0.08-0.15	0.08-0.2	0.08-0.18	0.1-0.25	0.1-0.15
			4 ••	Vc	100-130	70-100	110-150	90-120	140-180	100-130
				f	0.08-0.15	0.06-0.12	0.08-0.18	0.08-0.15	0.8-0.18	0.08-0.12
			6.3 •	Vc	80-100	60-90	80-100	70-90	100-140	80-120
				f	0.08-0.15	0.06-0.1	0.06-0.12	0.06-0.12	0.6-0.15	0.08-0.1
	Alloyed steel	HB>200	2.5 •••	Vc	130-150	120-140	130-150	120-140	140-170	120-150
				f	0.08-0.18	0.06-0.15	0.08-0.18	0.06-0.15	0.08-0.2	0.08-0.18
			4 ••	Vc	100-130	100-120	100-130	100-120	120-150	100-120
				f	0.08-0.15	0.06-0.13	0.08-0.15	0.06-0.13	0.08-0.18	0.08-0.15
			6.3 •	Vc	80-100	70-90	80-100	70-90	100-120	70-90
				f	0.08-0.12	0.06-0.11	0.08-0.12	0.06-0.11	0.08-0.12	0.06-0.11

ISO	Workpiece material	Hardness HB	Overhang L/D	Boring range D68-120		Boring range D120-200		Boring range D200-500		
				ap (mm)	0.8	2.5	0.8-2.0	2.0-3.5	0.8-2.0	2.0-4.0
				R (Radius)	0.2-0.4	0.4-0.8	0.2-0.4	0.4-0.8	0.2-0.4	0.4-0.8
P	Alloyed steel	HB<200	2.5 •••	Vc	160-220	140-180	160-220	140-180	160-220	140-180
				f	0.1-0.3	0.1-0.25	0.1-0.3	0.1-0.25	0.1-0.35	0.1-0.3
			4 ••	Vc	150-200	120-160	120-160	120-160	N.R.	N.R.
				f	0.1-0.2	0.08-0.18	0.1-0.2	0.08-0.18		
			6.3 •	Vc	100-140	100-140	N.R.	N.R.	N.R.	N.R.
				f	0.08-0.18	0.08-0.15				
	Alloyed steel	HB>200	2.5 •••	Vc	160-200	140-180	140-200	140-180	140-200	140-180
				f	0.1-0.3	0.01-0.25	0.01-0.35	0.01-0.3	0.01-0.35	0.01-0.3
			4 ••	Vc	140-160	120-140	150-180	120-140	N.R.	N.R.
				f	0.08-0.2	0.08-0.15	0.08-0.12	0.08-0.12		
			6.3 •	Vc	100-120	70-90	N.R.	N.R.	N.R.	N.R.
				f	0.08-0.16	0.08-0.12				

- N.R. = Not recommended
- In case of a single or a stepped boring cutter configuration, only half the feed should be applied

BHR Rough Boring Cutting Data

Stability *** – Good
** – Normal
* – Poor

ap(mm), R(radius), Vc(m/min), f(mm/rev)

ISO	Workpiece material	Hardness HB	Overhang L/D	Boring range D18-28		Boring range D28-50		Boring range D50-68		
				ap (mm)	0.5-1.0	1.0-1.8	0.5-1.0	1.0-1.8	0.5-1.2	1.2-2.0
				R (Radius)	0.2	0.4	0.2-0.4	0.4	0.2-0.4	0.4-0.8
M	Stainless steel	Ferritic & martensitic	2.5 ***	Vc	100-150	110-130	120-160	100-150	120-160	110-160
				f	0.08-0.15	0.06-0.12	0.08-0.18	0.06-0.12	0.08-0.25	0.08-0.18
			4 **	Vc	90-130	90-120	100-140	90-140	100-150	80-120
				f	0.08-0.12	0.06-0.1	0.08-0.12	0.06-0.1	0.08-0.18	0.08-0.12
			6.3 *	Vc	60-90	50-70	60-90	50-70	70-100	50-70
				f	0.06-0.1	0.06-0.1	0.06-0.12	0.06-0.1	0.06-0.15	0.08-0.1
	Stainless steel	Austenitic	2.5 ***	Vc	110-130	100-130	120-150	110-140	110-160	100-150
				f	0.08-0.15	0.06-0.12	0.08-0.18	0.06-0.12	0.08-0.25	0.06-0.12
			4 **	Vc	80-110	80-110	90-130	90-120	100-150	90-130
				f	0.08-0.12	0.06-0.1	0.08-0.12	0.06-0.1	0.08-0.18	0.06-0.1
			6.3 *	Vc	60-90	50-70	60-90	50-70	70-100	50-70
				f	0.06-0.1	0.06-0.1	0.06-0.12	0.06-0.1	0.06-0.15	0.06-0.1
Stainless steel cast	Ferritic & martensitic	2.5 ***	Vc	90-130	100-130	120-150	110-140	120-160	100-150	
			f	0.08-0.15	0.06-0.12	0.08-0.18	0.06-0.12	0.08-0.25	0.06-0.12	
		4 **	Vc	70-110	80-110	90-130	90-120	100-150	90-130	
			f	0.08-0.12	0.06-0.1	0.08-0.12	0.06-0.1	0.08-0.18	0.06-0.1	
		6.3 *	Vc	60-90	50-70	60-90	50-70	70-100	50-70	
			f	0.06-0.1	0.06-0.1	0.06-0.12	0.06-0.1	0.06-0.15	0.06-0.1	
Stainless steel cast	Austenitic	2.5 ***	Vc	80-120	70-110	100-150	90-140	110-150	100-150	
			f	0.08-0.15	0.06-0.12	0.08-0.18	0.06-0.12	0.08-0.25	0.06-0.12	
		4 **	Vc	70-100	70-100	80-130	70-120	90-140	90-130	
			f	0.08-0.12	0.06-0.1	0.08-0.12	0.06-0.1	0.08-0.18	0.06-0.1	
		6.3 *	Vc	60-90	50-70	60-90	50-70	70-100	50-70	
			f	0.06-0.1	0.06-0.1	0.06-0.12	0.06-0.1	0.06-0.15	0.06-0.1	

ISO	Workpiece material	Hardness HB	Overhang L/D	Boring range D68-120		Boring range D120-200		Boring range D200-500		
				ap (mm)	0.8-1.8	1.8-2.5	0.8-2.0	2.0-3.0	0.8-2.0	2.0-3.5
				R (Radius)	0.2-0.4	0.4-0.8	0.2-0.4	0.4-0.8	0.2-0.4	0.2-0.4
M	Stainless steel	Ferritic & martensitic	2.5 ***	Vc	130-220	120-200	140-220	120-180	150-220	120-200
				f	0.08-0.3	0.08-0.25	0.08-0.3	0.08-0.25	0.08-0.3	0.08-0.25
			4 **	Vc	100-160	90-140	120-180	90-140	N.R.	N.R.
				f	0.08-0.25	0.08-0.18	0.08-0.25	0.08-0.18		
			6.3 *	Vc	70-100	50-70	N.R.	N.R.	N.R.	N.R.
				f	0.08-0.2	0.08-0.15				
	Stainless steel	Austenitic	2.5 ***	Vc	120-200	100-160	120-200	100-160	120-200	100-180
				f	0.08-0.3	0.08-0.25	0.08-0.3	0.08-0.25	0.08-0.3	0.08-0.25
			4 **	Vc	100-150	90-140	100-160	90-140	N.R.	N.R.
				f	0.08-0.25	0.08-0.18	0.08-0.25	0.08-0.18	0.08-0.18	0.06-0.1
			6.3 *	Vc	70-100	50-70	N.R.	N.R.	N.R.	N.R.
				f	0.08-0.2	0.08-0.15				
Stainless steel cast	Ferritic & martensitic	2.5 ***	Vc	130-200	120-180	140-200	120-160	140-200	120-180	
			f	0.08-0.3	0.08-0.25	0.08-0.3	0.08-0.25	0.08-0.3	0.08-0.25	
		4 **	Vc	110-150	90-150	100-160	90-140	N.R.	N.R.	
			f	0.08-0.25	0.08-0.18	0.08-0.25	0.08-0.18			
		6.3 *	Vc	70-100	50-70	N.R.	N.R.	N.R.	N.R.	
			f	0.08-0.2	0.08-0.15					
Stainless steel cast	Austenitic	2.5 ***	Vc	130-180	120-180	120-200	100-160	120-200	100-180	
			f	0.08-0.3	0.08-0.25	0.08-0.3	0.08-0.25	0.08-0.3	0.08-0.25	
		4 **	Vc	100-140	90-140	100-160	90-140	N.R.	N.R.	
			f	0.08-0.25	0.08-0.18	0.08-0.25	0.08-0.18			
		6.3 *	Vc	70-190	50-70	N.R.	N.R.	N.R.	N.R.	
			f	0.08-0.2	0.08-0.15					

- N.R. = Not recommended
- In case of a single or a stepped boring cutter configuration, only half the feed should be applied

BHR Rough Boring Cutting Data

Stability ••• – Good
•• – Normal
• – Poor

ap(mm), R(radius), Vc(m/min), f(mm/rev)

ISO	Workpiece material	Hardness HB	Overhang L/D	Boring range D18-28			Boring range D28-50		Boring range D50-68	
				ap (mm)	0.5-1.0	1.0-1.8	0.5-1.0	1.0-1.8	0.5-1.2	1.2-2.0
				R (Radius)	0.2-0.4	0.4	0.2-0.4	0.4	0.2-0.4	0.4-0.8
K	Gray cast iron GG 10-25	HB<200	2.5 •••	Vc	120-160	100-140	120-180	110-150	120-180	110-150
				f	0.06-0.15	0.06-0.18	0.06-0.15	0.06-0.12	0.08-0.2	0.08-0.12
			4 ••	Vc	100-140	80-120	100-150	80-120	100-150	80-120
				f	0.06-0.12	0.06-0.1	0.06-0.12	0.06-0.1	0.08-0.12	0.08-0.1
			6.3 •	Vc	70-100	60-90	70-100	60-90	70-100	60-90
				f	0.06-0.1	0.06-0.1	0.06-0.1	0.06-0.1	0.08-0.1	0.08-0.1
	Gray cast iron GG 25-40		2.5 •••	Vc	140-200	140-200	140-220	160-250	180-220	200-280
				f	0.06-0.15	0.06-0.18	0.06-0.15	0.06-0.18	0.08-0.2	0.1-0.25
			4 ••	Vc	120-160	120-160	120-180	140-200	140-180	180-220
				f	0.06-0.12	0.06-0.14	0.06-0.12	0.06-0.14	0.08-0.12	0.08-0.2
			6.3 •	Vc	70-100	60-90	70-100	60-90	60-100	60-120
				f	0.06-0.1	0.06-0.1	0.06-0.1	0.06-0.1	0.08-0.1	0.08-0.1
Cast iron GGG	Spheroidal & graphite	2.5 •••	Vc	120-180	120-180	120-200	140-220	180-220	180-240	
			f	0.06-0.15	0.06-0.18	0.06-0.15	0.06-0.18	0.08-0.18	0.1-0.2	
		4 ••	Vc	120-160	120-160	120-180	140-200	140-200	160-220	
			f	0.06-0.12	0.06-0.14	0.06-0.12	0.06-0.14	0.08-0.12	0.08-0.18	
		6.3 •	Vc	60-100	60-90	60-100	60-90	60-90	60-100	
			f	0.06-0.1	0.06-0.1	0.06-0.1	0.06-0.1	0.08-0.1	0.08-0.1	

ISO	Workpiece material	Hardness HB	Overhang L/D	Boring range D18-28		Boring range D28-50		Boring range D50-68		
				ap (mm)	0.8-1.8	1.8-2.5	0.8-2.0	2.0-3.0	0.8-2.0	2.0-3.5
				R (Radius)	0.2-0.4	0.4-0.8	0.2-0.4	0.4-0.8	0.2-0.4	0.4-0.8
K	Gray cast iron GG 10-25	HB<200	2.5 •••	Vc	120-200	110-150	150-250	180-280	150-250	180-280
				f	0.08-0.25	0.08-0.3	0.08-0.25	0.08-0.35	0.08-0.25	0.08-0.35
			4 ••	Vc	100-150	80-120	120-170	120-170	N.R.	N.R.
				f	0.08-0.18	0.08-0.2	0.08-0.18	0.08-0.25		
			6.3 •	Vc	70-100	60-90	N.R.	N.R.	N.R.	N.R.
				f	0.08-0.15	0.08-0.12				
	Gray cast iron GG 25-40		2.5 •••	Vc	50-300	250-350	250-350	250-350	250-350	250-350
				f	0.12-0.35	0.12-0.35	0.15-0.3	0.15-0.4	0.15-0.3	0.15-0.4
			4 ••	Vc	200-270	230-300	200-300	200-270	N.R.	N.R.
				f	0.1-0.25	0.12-0.3	0.15-0.3	0.15-0.35		
			6.3 •	Vc	70-150	60-120	N.R.	N.R.	N.R.	N.R.
				f	0.1-0.15	0.12-0.25				
Cast iron GGG	Spheroidal & graphite	2.5 •••	Vc	200-240	200-280	200-280	220-300	220-300	220-300	
			f	0.12-0.3	0.12-0.3	0.15-0.3	0.15-0.35	0.15-0.3	0.15-0.35	
		4 ••	Vc	160-220	180-240	180-250	200-270	N.R.	N.R.	
			f	0.1-0.2	0.12-0.25	0.15-0.25	0.15-0.35			
		6.3 •	Vc	60-100	60-100	N.R.	N.R.	N.R.	N.R.	
			f	0.1-0.15	0.12-0.2					

- N.R. = Not recommended
- In case of a single or a stepped boring cutter configuration, only half the feed should be applied

BHR Rough Boring Cutting Data

Stability *** – Good
** – Normal
• – Poor

ap(mm), R(radius), Vc(m/min), f(mm/rev)

ISO	Workpiece material	Hardness HB	Overhang L/D	Boring range D18-28		Boring range D28-50		Boring range D50-68		
				ap (mm)	0.5-1.5	1.5-2.5	0.5-1.5	1.5-2.5	0.5-2.0	1.2-3.0
				R (Radius)	0.2-0.4	0.4	0.2-0.4	0.4	0.2-0.4	0.4-0.8
N	Aluminum/ Cast	>12si	2.5 ***	Vc	200-300	240-350	200-300	240-350	200-300	240-350
				f	0.06-0.2	0.06-0.25	0.06-0.2	0.06-0.25	0.06-0.25	0.06-0.3
			4 **	Vc	150-220	150-220	150-220	150-220	150-220	150-220
				f	0.06-0.2	0.06-0.2	0.06-0.2	0.06-0.2	0.06-0.2	0.06-0.2
			6.3 •	Vc	60-100	60-100	60-100	60-100	60-100	60-100
				f	0.06-0.1	0.06-0.1	0.06-0.1	0.06-0.1	0.06-0.1	0.06-0.1
	Aluminum/ Cast	<12si	2.5 ***	Vc	180-250	220-280	180-250	220-280	180-250	220-280
				f	0.06-0.2	0.06-0.25	0.06-0.25	0.06-0.25	0.06-0.25	0.06-0.3
			4 **	Vc	120-220	120-220	120-220	120-220	120-220	120-220
				f	0.06-0.2	0.06-0.2	0.06-0.2	0.06-0.2	0.06-0.2	0.06-0.25
			6.3 •	Vc	60-100	60-100	60-100	60-100	60-100	60-100
				f	0.06-0.1	0.06-0.1	0.06-0.1	0.06-0.1	0.06-0.1	0.06-0.1
ISO	Workpiece material	Hardness HB	Overhang L/D	Boring range D68-120		Boring range D120-200		Boring range D200-500		
				ap (mm)	0.8-3.0	1.8-4.0	0.8-3.0	2.0-4.0	0.8-3.0	2.0-4.5
				R (Radius)	0.2-0.4	0.4-0.8	0.2-0.4	0.4-0.8	0.2-0.4	0.4-0.8
N	Aluminum/ Cast	>12si	2.5 ***	Vc	200-300	240-350	200-300	240-350	200-300	240-350
				f	0.06-0.25	0.06-0.3	0.06-0.25	0.06-0.4	0.06-0.25	0.06-0.4
			4 **	Vc	150-220	150-220	150-220	150-220	N.R.	N.R.
				f	0.06-0.2	0.06-0.2	0.06-0.2	0.06-0.2		
			6.3 •	Vc	60-100	60-100	N.R.	N.R.	N.R.	N.R.
				f	0.06-0.1	0.06-0.1				
	Aluminum/ Cast	<12si	2.5 ***	Vc	180-250	220-280	180-250	220-280	180-250	220-280
				f	0.06-0.25	0.06-0.3	0.06-0.3	0.06-0.4	0.06-0.3	0.06-0.4
			4 **	Vc	120-220	120-220	120-220	120-220	N.R.	N.R.
				f	0.06-0.2	0.06-0.25	0.06-0.2	0.06-0.25		
			6.3 •	Vc	60-100	60-100	N.R.	N.R.	N.R.	N.R.
				f	0.06-0.1	0.06-0.1				

- N.R. = Not recommended
- In case of a single or a stepped boring cutter configuration, only half the feed should be applied