







Inhalt
Contents
Содержание

<p>Drehen</p> <ul style="list-style-type: none"> • Außenbearbeitung • Innenbearbeitung • Wendeschneidplatten • Gewindedrehen 		<p>Turning</p> <ul style="list-style-type: none"> • External machining • Internal machining • Indexable inserts • Thread turning 	<p>Точение</p> <ul style="list-style-type: none"> • Наружная обработка 1.1 - 1.18 • Внутренняя обработка 1.19 - 1.42 • Сменные пластины 1.43 - 1.90 • Резьбонарезание 1.91 - 1.110 	<p>1</p>
<p>DECO-CUT</p> <ul style="list-style-type: none"> • Grundhalter • Schneideinsätze • Information 		<p>DECO-CUT</p> <ul style="list-style-type: none"> • Holders • Inserts • Information 	<p>DECO-CUT</p> <ul style="list-style-type: none"> • Державки 2.2 - 2.6 • Пластины 2.7 - 2.16 • Информация 2.17 - 2.19 	<p>2</p>
<p>Stechen</p> <ul style="list-style-type: none"> • Inhalt • CLIP-GROOVE ° • NC-Stechdrehsystem • SHORT-CUT ° • DROP-CUT ° 		<p>Grooving</p> <ul style="list-style-type: none"> • Contents • CLIP-GROOVE ° • NC-grooving and copy turning • SHORT-CUT ° • DROP-CUT ° 	<p>Обработка канавок</p> <ul style="list-style-type: none"> • Содержание • CLIP-GROOVE ° 3.5 - 3.8 • NC-grooving и копировальное точение 3.9 - 3.12 • SHORT-CUT ° 3.13 - 3.14 • DROP-CUT ° 3.15 - 3.16 	<p>3</p>
<p>MICRO-Werkzeuge</p> <ul style="list-style-type: none"> • Schneideinsätze • VHM-Axialstechwerkzeug 		<p>MICRO-Tools</p> <ul style="list-style-type: none"> • Inserts • Solid carbide face grooving tools 	<p>МИКРО ИНСТРУМЕНТ</p> <ul style="list-style-type: none"> • П л а с т и н ы 4.1 - 4.12 • Твердосплавный инструмент для аксиальной обработки 4.13 - 4.15 	<p>4</p>
<p>Bohren SHARK-CUT °</p> <ul style="list-style-type: none"> • Inhalt • Grundhalter • Wendeschneidplatten • SHARK-CUT ° - Mini 		<p>Drilling SHARK-CUT °</p> <ul style="list-style-type: none"> • Contens • Holders • Indexable inserts • SHARK-CUT ° - Mini 	<p>Сверление SHARK-CUT °</p> <ul style="list-style-type: none"> • Содержание 5.3 • Державки 5.4 - 5.5 • Сменные пластины 5.6 - 5.9 • SHARK-CUT ° - Mini 5.10 	<p>5</p>
<p>Informationen</p>		<p>Information</p>	<p>Информация</p> <p>i.1 - i.16</p>	<p>i</p>
<p>Alphanumerischer Index</p>		<p>Alphanumerical index</p>	<p>Алфавитный указатель</p> <p>A.1 - A.2</p>	<p>A</p>



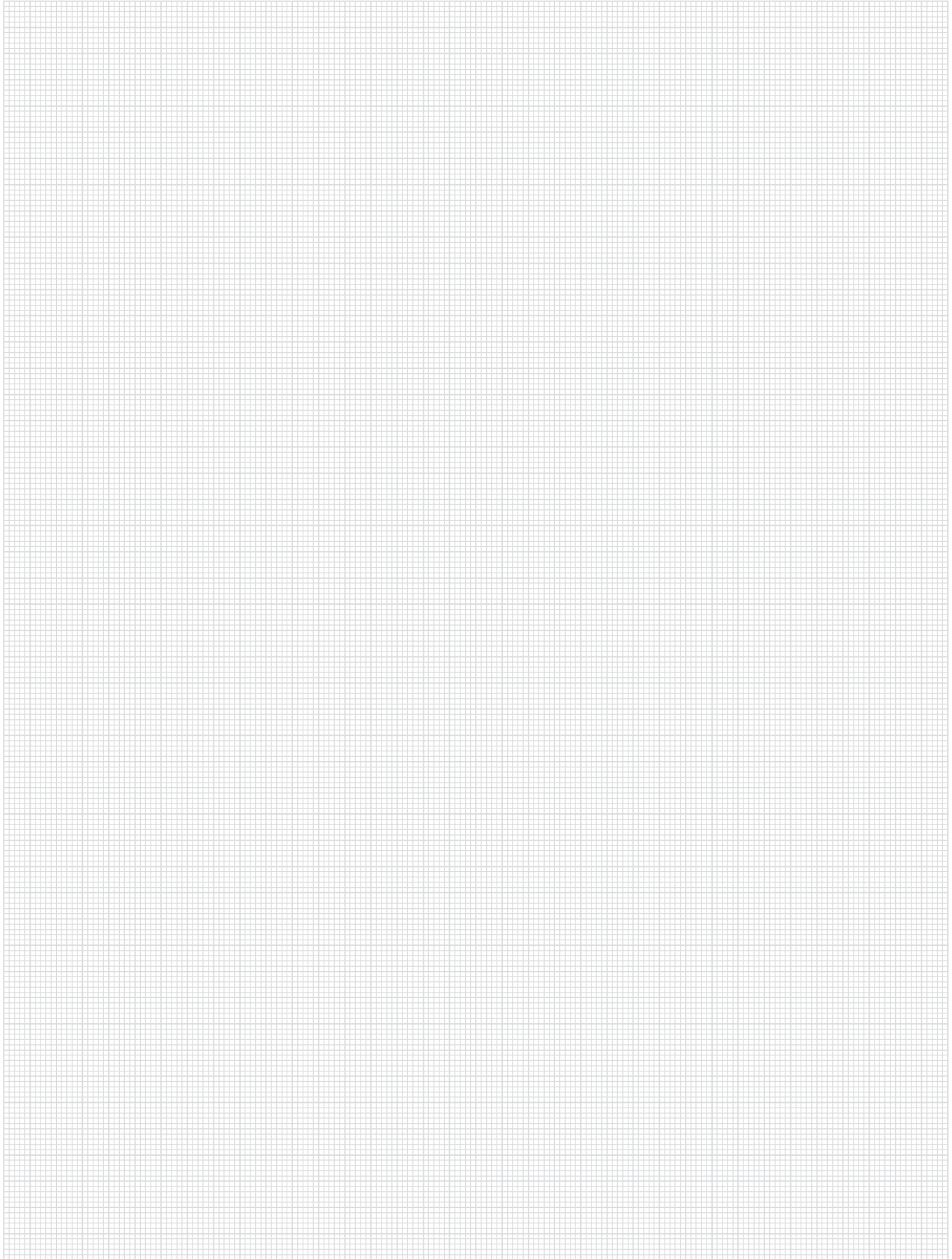

Außenbearbeitung External machining Наружная Обработка

1





ARNO[®]
WERKZEUGE

ISO-Bezeichnungssystem für Klemmhalter

ISO designation system for toolholder

Система обозначений ISO державок для наружной обработки

1

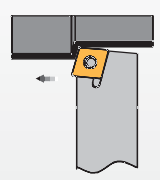
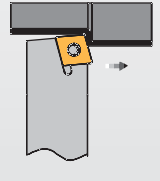
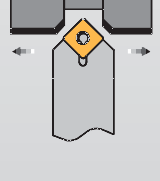
 <p>C Von oben geklemmt Top clamping Прижим сверху</p> <p>D Von oben und über Bohrung geklemmt Top and hole clamping Прижим повышенной жёсткости</p> <p>M Von oben und über Bohrung geklemmt Top and hole clamping Прижим сверху и прижим за отверстие</p> <p>P Über Bohrung geklemmt Hole clamping Прижим рычагом за отверстие</p> <p>S Durch Bohrung aufgeschraubt With screw through hole Закрепление винтом</p>	<p>80° C 55° D 75° E 86° M 35° V</p> <p>85° A 82° B 55° K</p> <p>H L O P R S T W</p>	<p>A B C D E F G H J K L M N R S T U V W Y</p>	 <p>3° A 5° B 7° C 15° D 20° E 25° F 30° G 0° N 11° P</p> <p>Sonstige Others Другие типы ⇨ O</p>	<p>R</p>  <p>L</p>  <p>N</p> 
<p>P</p>	<p>C</p>	<p>L</p>	<p>N</p>	<p>L</p>
<p>Klemmsystem Clamping method Система крепления</p>	<p>Plattenform Shape Форма пластины</p>	<p>Halterform Style Тип державки</p>	<p>Freiwinkel Clearance angle Задний угол</p>	<p>Halter- ausführung Holder execution Исполнение</p>



ISO-Bezeichnungssystem für Klemmhalter
 ISO designation system for toolholder
 Система обозначений ISO державок для наружной обработки

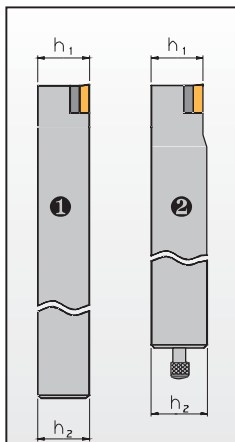

Höhe der Schneidecke „h₁“ in mm.
 Bei Klemmhaltern ① ist die Höhe der Schneidecke „h₁“ gleich und bei Kurzklemmhaltern ② in der Regel ungleich der Schaft-höhe „h₂“.

Height of cutting edge „h₁“ in mm.
 For toolholders the height of the cutting edge „h₁“ is equal to the height of shank. For cartridges the height of cutting edge „h₁“ is unequal to the height of shank.

Высота режущей кромки «h₁» в мм.
 Для державок высота «h₁» равна высоте стержня державки.
 Для картриджей высота «h₁» не равна высоте стержня державки

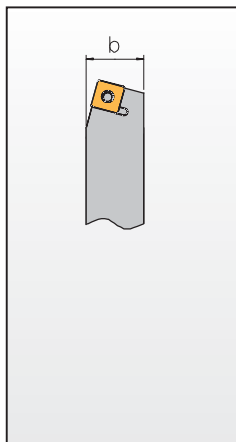

Schaftbreite „b“ in mm.
 Bei Kurzklemmhaltern entfällt die Angabe der Schaftbreite. Sie ist durch die Buchstaben „CA“ ersetzt.

Width „b“ in mm.
 Cartridges do not show any width. The width is replaced by the letters „CA“.

Ширина державки «b».
 Для картриджей ширина не указывается. Она заменена на параметр «CA».

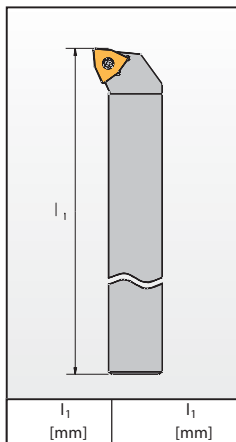

	l ₁ [mm]		l ₁ [mm]
A	32	M	150
B	40	N	160
C	50	P	170
D	60	Q	180
E	70	R	200
F	80	S	250
G	90	T	300
H	100	U	350
J	110	V	400
K	125	W	450
L	140	Y	500

Sonderlänge
 Special length ⇔ X
 Специальная длина

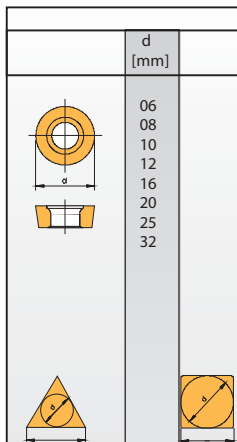

		d [mm]		
		06		
		08		
		10		
		12		
		16		
		20		
		25		
		32		
[mm]	[inch]	[mm]	[mm]	
06	5/32	3,97	03	
08	3/16	4,76	04	
09	7/32	5,56	05	
11	1/4	6,35	06	
16	3/8	9,525	09	
22	1/2	12,7	12	
27	5/8	15,875	15	
33	3/4	19,05	19	
44	1	25,4	25	

Für besondere Produktmerkmale kann an der 10. Stelle ein firmeninterner Code angeführt werden.

Special product information can be indicated by an internal company coding system at the 10th position.

Дополнительную информацию изготовитель может заложить в соответствие с внутренней системой кодирования на 10-ой позиции

20	20	K	12	...
Schafthöhe Height of shank Высота державки	Schaftbreite Width Ширина державки	Halterlänge Length Общая длина державки	Schneidenlänge Edge length Длина режущей кромки	Zusatzangabe Additional coding system Дополнительная информация





Außenbearbeitung - Übersicht

External machining - Program overview

Наружная обработка - обзор программы

1

Schraubenklemmung - positiv
Screw clamping - positive
Закрепление винтом - позитивные

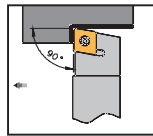

SCAC
R/L
Seite
Page 1.5
Страница

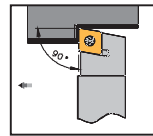

SCAP
R/L
Seite
Page 1.6
Страница

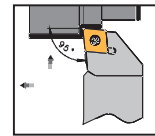

SCLC
R/L
Seite
Page 1.7
Страница

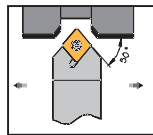

SCMC
N
Seite
Page 1.8
Страница

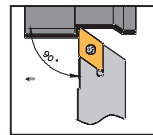

SDAC
R/L
Seite
Page 1.9
Страница

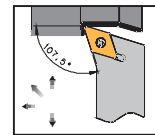

SDHC
R/L
Seite
Page 1.10
Страница

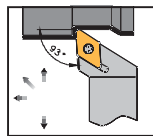

SDJC
R/L
Seite
Page 1.11
Страница

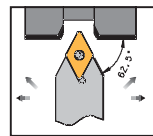

SDNC
N
Seite
Page 1.12
Страница

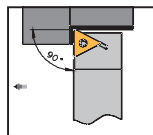

STAC
R/L
Seite
Page 1.13
Страница

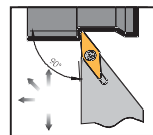

SVAC
R/L
Seite
Page 1.14
Страница

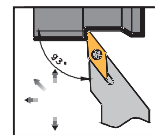

SVJC
R/L
Seite
Page 1.15
Страница

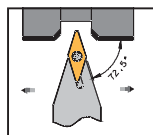

SVVC
N
Seite
Page 1.16
Страница

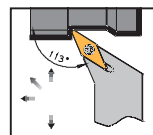

SVXC
R/L
Seite
Page 1.17
Страница

Set Drehmoment - Schraubendreher
Set Torque screwdriver
Наборы отверток



Seite
Page 1.18
Страница



Klemmhalter mit Schraubenklemmung
 Toolholder with screw clamping
 Закрепление винтом

SCAC R/L

Anstellwinkel / Approach angle / Угол в плане: **90°**

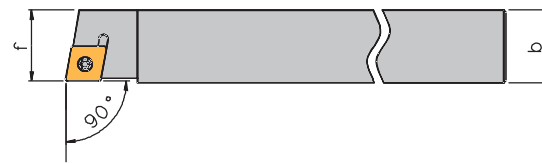
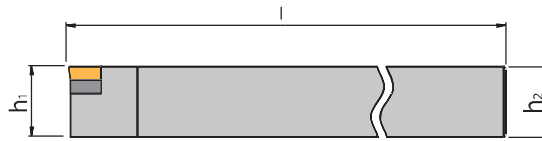
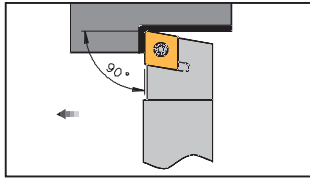

Rechte Ausführung abgebildet
 Right-hand execution shown
 Показано правостороннее исполнение

Halter / Holder / Державки

Bezeichnung Designation Обозначение	h_1 / h_2	b	l_1	l_2	f	Wendeschneidplatte Indexable insert Пластины
SCAC R/L 0808 D 06	8	8	60	9	8	CC.. 0602..
SCAC R/L 0808 K 06	8	8	125	9	8	CC.. 0602..
SCAC R/L 1010 E 06	10	10	70	9	10	CC.. 0602..
SCAC R/L 1010 M 06	10	10	150	9	10	CC.. 0602..
SCAC R/L 1212 F 09	12	12	80	13	12	CC.. 09T3..
SCAC R/L 1212 M 09	12	12	150	13	12	CC.. 09T3..
SCAC R/L 1414 M 09	14	14	150	13	14	CC.. 09T3..
SCAC R/L 1616 H 09	16	16	100	13	16	CC.. 09T3..
SCAC R/L 2020 K 12	20	20	125	17	20	CC.. 1204..
SCAC R/L 0808 X06-A	8	8	115	-	8	CC.. 0602...
SCAC R/L 1010 X06-A	10	10	115	-	10	CC.. 0602...
SCAC R/L 1212 X06-A	12	12	130	-	12	CC.. 0602...
SCAC R/L 1212 X09-A	12	12	130	-	12	CC.. 09T3...
SCAC R/L 1616 X09-A	16	16	130	-	16	CC.. 09T3...
SCAC R/L 2020 X09-A	20	20	120	-	20	CC.. 09T3...

Ersatzteile / Spare parts / Комплекующие

Für Halter For holder Для державки	Unterlage Support pad Опорная пластина	Büchse Bush Винт опорной пластины	Schraube Screw Винт	Schlüssel Key Ключ	Sortiment Spare part set Набор комплектующих
SC.. R/L..06	-	-	SS 1751	KS 1751	S 1751
SC.. R/L..1212 -1414.09	-	-	SS 1111	KS 1111	S 1111
SC.. R/L..1616.09	US 1111	GBS 1111	SS 1111	KS 1115	S 1116
SC.. R/L..12	US 1221	GBS 1221	SS 1221	KS 1115	S 1221
SCAC R/L... X06-A	-	-	SS 1751	KS 1751	-
SCAC R/L... X09-A	-	-	V-M4-2200	KS 1111	-

Sortiment besteht aus: 3 Schrauben, 1 Schlüssel und je nach Haltertyp 1 Unterlage, 1 Büchse.
 Complete set consists of: 3 Torx-screws, 1 Torx-screwdriver and depending on type of toolholder 1 support pad, 1 bush.
 Набор комплектующих включает: Винт - 3 шт., Отвертка - 1 шт., в зависимости от типа державки: опорная пластина 1 шт., винт опорной пластины - 1 шт..

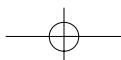



Klemmhalter mit Schraubenklemmung
 Toolholder with screw clamping
 Закрепление винтом

1

SCAP R/L

Anstellwinkel / Approach angle / Угол в плане: **90°**

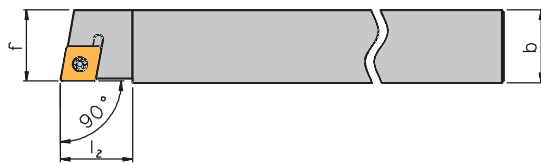
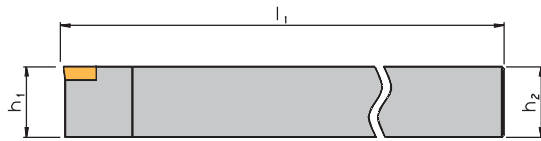
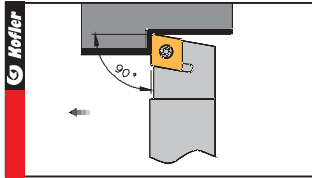

Rechte Ausführung abgebildet
 Right-hand execution shown
 Показано правостороннее исполнение

Halter / Holder / Державки

Bezeichnung Designation Обозначение	h_1 / h_2	b	l_1	l_2	f	Wendeschneidplatte Indexable insert Пластины
SCAP R/L 0808 K 05	8	8	125	10	8,5	CP. 05T1..
SCAP R/L 1010 M05	10	10	150	10	10,5	CP. 05T1..
SCAP R/L 1212 M05	12	12	150	12	12,5	CP. 05T1..

Ersatzteile / Spare parts / Комплекующие

Für Halter For holder Для державки	Unterlage Support pad Опорная пластина	Büchse Bush Винт опорной пластины	Schraube Screw ВИНТ	Schlüssel Key Ключ
SC.. R/L..05	-	-	T 2,2.04	KS 5151



Klemmhalter mit Schraubenklemmung
 Toolholder with screw clamping
 Закрепление винтом

SCLC R/L

Anstellwinkel / Approach angle / Угол в плане: **95°**

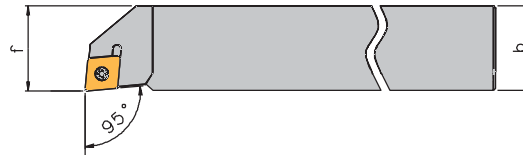
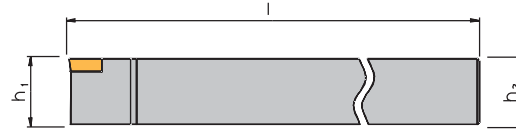
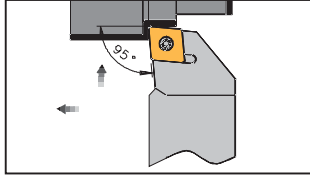

Rechte Ausführung abgebildet
 Right-hand execution shown
 Показано правостороннее исполнение

Halter / Holder / Державки

Bezeichnung Designation Обозначение	h_1 / h_2	b	l	f = b	Wendeschneidplatte Indexable insert Пластини
SCLC R/L 0808 X06-A	8	8	115	8	CC.. 0602...
SCLC R/L 1010 X06-A	10	10	115	10	CC.. 0602...
SCLC R/L 1212 X06-A	12	12	130	12	CC.. 0602...
SCLC R/L 1212 X09-A	12	12	130	12	CC.. 09T3...
SCLC R/L 1616 X09-A	16	16	130	16	CC.. 09T3...
SCLC R/L 2020 X09-A	20	20	120	20	CC.. 09T3...

Ersatzteile / Spare parts / Комплекующие

Für Halter For holder Для державки	Schraube Screw Винт	Schlüssel Key Ключ
SCLC R/L... X06-A	SS 1751	KS 1751
SCLC R/L... X09-A	V-M4-2200	KS 1111

Hinweis: Auflage- und Anlageflächen geschliffen.
 Remark: All flats ground.
 Примечания: Все поверхности шлифованные.

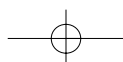



Klemmhalter mit Schraubenklemmung
 Toolholder with screw clamping
 Закрепление винтом

1

SCMC N

Anstellwinkel / Approach angle / Угол в плане: **90°**

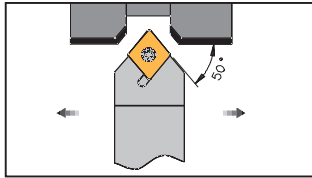

Rechte Ausführung abgebildet
 Right-hand execution shown
 Показано правостороннее исполнение

Halter / Holder / Державки

Bezeichnung Designation Обозначение	h ₁ / h ₂	b	l	f	Wendeschneidplatte Indexable insert Пластини
SCMC N 0808 X06-A	8	8	115	4	CC.. 0602...
SCMC N 1010 X06-A	10	10	115	5	CC.. 0602...
SCMC N 1212 X06-A	12	12	130	6	CC.. 0602...
SCMC N 1212 X09-A	12	12	130	6	CC.. 09T3...
SCMC N 1616 X09-A	16	16	130	8	CC.. 09T3...
SCMC N 2020 X09-A	20	20	120	10	CC.. 09T3...

Ersatzteile / Spare parts / Комплекующие

Für Halter For holder Для державки	Schraube Screw Винт	Schlüssel Key Ключ
SCMC N... X06-A	SS 1751	KS 1751
SCMC N... X09-A	V-M4-2200	KS 1111

Hinweis: Auflage- und Anlageflächen geschliffen.
 Remark: All flats ground.
 Примечание: Все поверхности шлифованные



Klemmhalter mit Schraubenklemmung
 Toolholder with screw clamping
 Закрепление винтом

SDAC R/L

Anstellwinkel / Approach angle / Угол в плане: **90°**

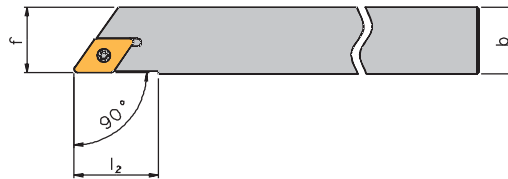
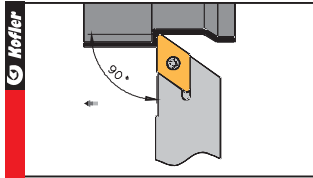

Rechte Ausführung abgebildet
 Right-hand execution shown
 Показано правостороннее исполнение

Halter / Holder / Державки

Bezeichnung Designation Обозначение	h ₁ / h ₂	b	l	f = b	Wendeschneidplatte Indexable insert Пластины
SDAC R/L 0808 X07-A	8	8	115	8	DC.. 0702...
SDAC R/L 1010 X07-A	10	10	115	10	DC.. 0702...
SDAC R/L 1212 X07-A	12	12	130	12	DC.. 0702...
SDAC R/L 1212 X11-A	12	12	130	12	DC.. 11T3...
SDAC R/L 1616 X11-A	16	16	130	16	DC.. 11T3...
SDAC R/L 2020 X11-A	20	20	120	20	DC.. 11T3...

Ersatzteile / Spare parts / Ricambi

Für Halter For holder Для державки	Schraube Screw Винт	Schlüssel Key Ключ
SDAC R/L... X07-A	SS 1751	KS 1751
SDAC R/L... X11-A	V-M4-2400	KS 1111

Hinweis: Auflage- und Anlageflächen geschliffen.
 Remark: All flats ground.
 Примечание: Все поверхности шлифованные.

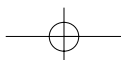



Klemmhalter mit Schraubenklemmung
 Toolholder with screw clamping
 Закрепление винтом

1

SDHC R/L

Anstellwinkel / Approach angle / Угол в плане: **107,5°**

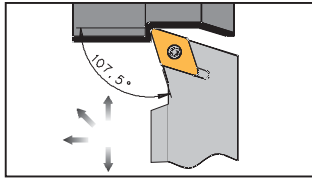

Rechte Ausführung abgebildet
 Right-hand execution shown
 Показано правостороннее исполнение

Halter / Holder / Державки

Bezeichnung Designation Обозначение	h ₁ / h ₂	b	l	f = b	Wendeschneidplatte Indexable insert Пластини
SDHC R/L 0808 X07-A	8	8	115	8	DC.. 0702...
SDHC R/L 1010 X07-A	10	10	115	10	DC.. 0702...
SDHC R/L 1212 X07-A	12	12	130	12	DC.. 0702...
SDHC R/L 1616 X07-A	16	16	130	16	DC.. 0702...
SDHC R/L 1616 X11-A	16	16	130	16	DC.. 11T3...
SDHC R/L 2020 X11-A	20	20	120	20	DC.. 11T3...

Ersatzteile / Spare parts / Комплекующие

Für Halter For holder Для державки	Schraube Screw Винт	Schlüssel Key Ключ
SDHC R/L... X07-A	SS 1751	KS 1751
SDHC R/L... X11-A	V-M4-2400	KS 1111

Hinweis: Auflage- und Anlageflächen geschliffen.
 Remark: All flats ground.
 Примечание: Все поверхности шлифованные.



Klemmhalter mit Schraubenklemmung
 Toolholder with screw clamping
 Закрепление винтом

SDJC R/L

Anstellwinkel / Approach angle / Угол в плане: **93°**

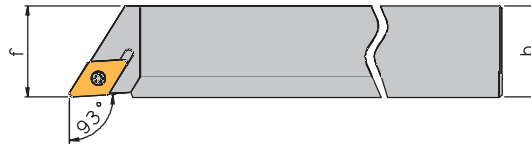
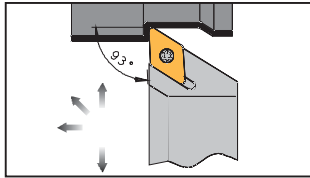

Rechte Ausführung abgebildet
 Right-hand execution shown
 Показано правостороннее исполнение

Halter / Holder / Державки

Bezeichnung Designation Обозначение	h_1 / h_2	b	l	f = b	Wendeschneidplatte Indexable insert Пластини
SDJC R/L 0808 X07-A	8	8	115	8	DC.. 0702...
SDJC R/L 1010 X07-A	10	10	115	10	DC.. 0702...
SDJC R/L 1212 X07-A	12	12	130	12	DC.. 0702...
SDJC R/L 1212 X11-A	12	12	130	12	DC.. 11T3...
SDJC R/L 1616 X11-A	16	16	130	16	DC.. 11T3...
SDJC R/L 2020 X11-A	20	20	120	20	DC.. 11T3...

Ersatzteile / Spare parts / Комплекующие

Für Halter For holder Для державки	Schraube Screw Винт	Schlüssel Key Ключ
SDJC R/L... X07-A	SS 1751	KS 1751
SDJC R/L... X11-A	V-M4-2400	KS 1111

Hinweis: Auflage- und Anlageflächen geschliffen.
 Remark: All flats ground.
 Примечание: Все поверхности шлифованные.

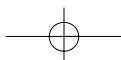



Klemmhalter mit Schraubenklemmung
 Toolholder with screw clamping
 Закрепление винтом

1

SDNC N

Anstellwinkel / Approach angle / Угол в плане: **62,5°**

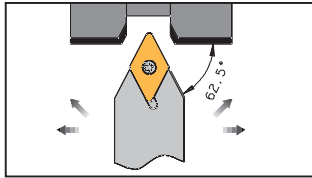

Halter / Holder / Державки

Bezeichnung Designation Обозначение	h ₁ / h ₂	b	l	f	Wendeschneidplatte Indexable insert Пластины
SDNC N 0808 X07-A	8	8	115	4	DC.. 0702...
SDNC N 1010 X07-A	10	10	115	5	DC.. 0702...
SDNC N 1212 X07-A	12	12	130	6	DC.. 0702...
SDNC N 1212 X11-A	12	12	130	6	DC.. 11T3...
SDNC N 1616 X11-A	16	16	130	8	DC.. 11T3...
SDNC N 2020 X11-A	20	20	120	10	DC.. 11T3...

Ersatzteile / Spare parts / Комплектующие

Für Halter For holder Для державки	Schraube Screw Винт	Schlüssel Key Ключ
SDNC N... X07-A	SS 1751	KS 1751
SDNC N... X11-A	V-M4-2400	KS 1111

Hinweis: Auflage- und Anlageflächen geschliffen.
 Remark: All flats ground.
 Примечание: Все поверхности шлифованные.



Klemmhalter mit Schraubenklemmung
 Toolholder with screw clamping
 Закрепление винтом

STAC R/L

Anstellwinkel / Approach angle / Угол в плане: **90°**

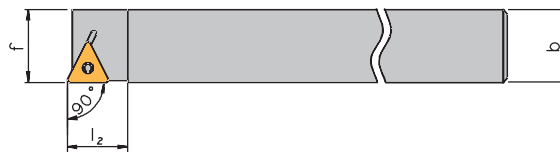
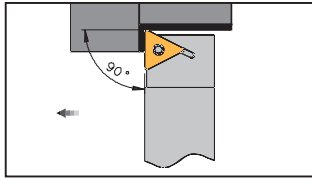

Rechte Ausführung abgebildet
 Right-hand execution shown
 Показано правостороннее исполнение

Halter / Holder / Державки

Bezeichnung Designation Обозначение	h_1 / h_2	b	l_1	f	Wendeschneidplatte Indexable insert Пластины
STAC R/L 0808 X06-A	8	8	115	8	TC.. 06T1...
STAC R/L 1010 X09-A	10	10	115	10	TC.. 0902...
STAC R/L 1212 X11-A	12	12	130	12	TC.. 1102...
STAC R/L 1616 X11-A	16	16	130	16	TC.. 1102...
STAC R/L 2020 X11-A	20	20	120	20	TC.. 1102...

Ersatzteile / Spare parts / Комплектующие

Für Halter For holder Для державки	Schraube Screw Винт	Schlüssel Key Ключ	Sortiment ¹ Spare part set Набор комплектующих
STAC R/L... X06-A	SS 5140	KS 1886	S 5140
STAC R/L... X09-A	SS 5151	KS 5151	S 5151
STAC R/L... X11-A	SS 1751	KS 1751	S 1751

¹ Sortiment besteht aus: 3 Schrauben, 1 Schlüssel
 Complete set consists of: 3 Torx-screws, 1 Torx-screwdriver
 Набор комплектующих включает: Винт-3 шт, Отвертка -1 шт

Hinweis: Auflage- und Anlageflächen geschliffen.
 Remark: All flats ground.
 Примечание: Все поверхности шлифованные.



Klemmhalter mit Schraubenklemmung
 Toolholder with screw clamping
 Закрепление винтом

1

SVAC R/L

Anstellwinkel / Approach angle / Угол в плане: **90°**

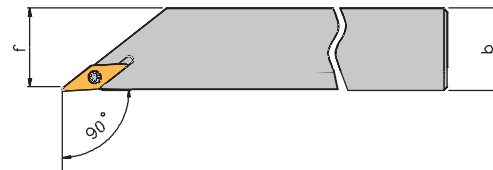
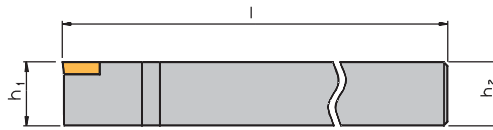
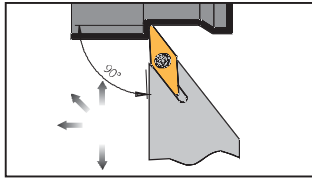

Rechte Ausführung abgebildet
 Right-hand execution shown
 Показано правостороннее исполнение

Halter / Holder / Державки

Bezeichnung Designation Обозначение	h ₁ / h ₂	b	l	f = b	Wendeschneidplatte Indexable insert Пластини
SVAC R/L 0808 X11-A	8	8	115	8	VC.. 1103...
SVAC R/L 1010 X11-A	10	10	115	10	VC.. 1103...
SVAC R/L 1212 X11-A	12	12	130	12	VC.. 1103...
SVAC R/L 1212 X16-A	12	12	130	12	VC.. 1604...
SVAC R/L 1616 X11-A	16	16	130	16	VC.. 1103...
SVAC R/L 1616 X16-A	16	16	130	16	VC.. 1604...
SVAC R/L 2020 X16-A	20	20	120	20	VC.. 1604...

Ersatzteile / Spare parts / Комплекующие

Für Halter For holder Для державки	Schraube Screw Винт	Schlüssel Key Ключ
SVAC R/L... X11-A	SS 1751	KS 1751
SVAC R/L... X16-A	V-M4-2700	KS 1111

Hinweis: Auflage- und Anlageflächen geschliffen.
 Remark: All flats ground.
 Примечание: Все поверхности шлифованные.



Klemmhalter mit Schraubenklammung
 Toolholder with screw clamping
 Закрепление винтом

SVJC R/L

Anstellwinkel / Approach angle / Угол в плане: **93°**

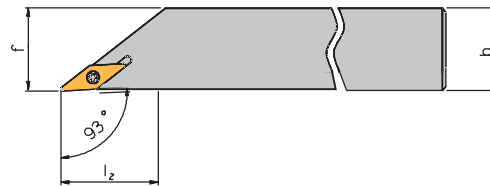
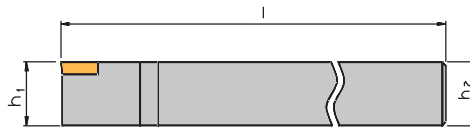
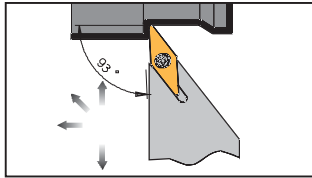

Rechte Ausführung abgebildet
 Right-hand execution shown
 Показано правостороннее исполнение

Halter / Holder / Державки

Bezeichnung Designation Обозначение	h ₁ / h ₂	b	l	f = b	Wendeschneidplatte Indexable insert Пластини
SVJC R/L 0808 X11-A	8	8	115	8	VC.. 1103...
SVJC R/L 1010 X11-A	10	10	115	10	VC.. 1103...
SVJC R/L 1212 X11-A	12	12	130	12	VC.. 1103...
SVJC R/L 1212 X16-A	12	12	130	12	VC.. 1604...
SVJC R/L 1616 X11-A	16	16	130	16	VC.. 1103...
SVJC R/L 1616 X16-A	16	16	130	16	VC.. 1604...
SVJC R/L 2020 X16-A	20	20	120	20	VC.. 1604...

Ersatzteile / Spare parts / Комплекующие

Für Halter For holder Для державки	Schraube Screw Винт	Schlüssel Key Ключ
SVJC R/L... X11-A	SS 1751	KS 1751
SVJC R/L... X16-A	V-M4-2700	KS 1111

Hinweis: Auflage- und Anlageflächen geschliffen.
 Remark: All flats ground.
 Примечание: Все поверхности шлифованные.

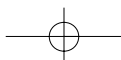



Klemmhalter mit Schraubenklammung
 Toolholder with screw clamping
 Закрепление винтом

1

SVVC N

Anstellwinkel / Approach angle / Угол в плане: **72,5°**

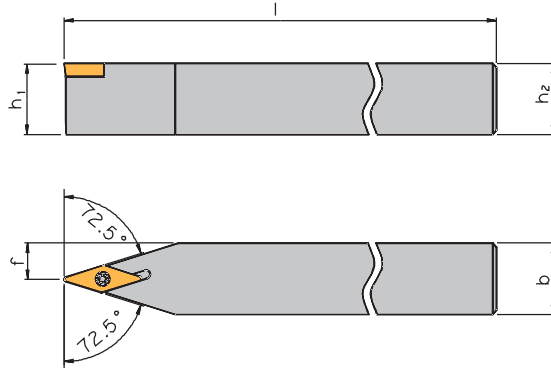
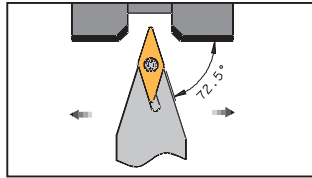

Halter / Holder / Державки

Bezeichnung Designation Обозначение	h_1 / h_2	b	l	f	Wendeschneidplatte Indexable insert Пластины
SVVC N 0808 X11-A	8	8	115	4	VC. 1103...
SVVC N 1010 X11-A	10	10	115	5	VC. 1103...
SVVC N 1212 X11-A	12	12	130	6	VC. 1103...
SVVC N 1212 X16-A	12	12	130	6	VC. 1604...
SVVC N 1616 X11-A	16	16	130	8	VC. 1103...
SVVC N 1616 X16-A	16	16	130	8	VC. 1604...
SVVC N 2020 X16-A	20	20	120	10	VC. 1604...

Ersatzteile / Spare parts / Комплекующие

Für Halter For holder Для державки	Schraube Screw Винт	Schlüssel Key Ключ
SVVC N... X11-A	SS 1751	KS 1751
SVVC N... X16-A	V-M4-2700	KS 1111

Hinweis: Auflage- und Anlageflächen geschliffen.
 Remark: All flats ground.
 Примечание: Все поверхности шлифованные.



Klemmhalter mit Schraubenklammung
 Toolholder with screw clamping
 Закрепление винтом

SVXC R/L

Anstellwinkel / Approach angle / Угол в плане: **107,5°**

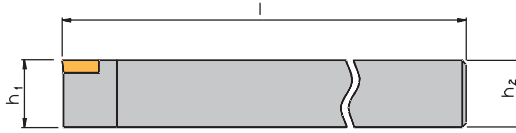
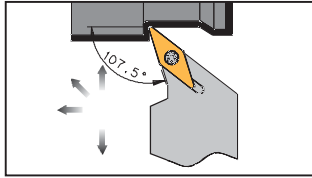

1

Halter / Holder / Stelo

Rechte Ausführung abgebildet
 Right-hand execution shown
 Показано правостороннее исполнение

Bezeichnung Designation Обозначение	h_1 / h_2	b	l	f = b	Wendeschneidplatte Indexable insert Пластини
SVXC R/L 1616 X11-A	16	16	130	16	VC.. 1103...
SVXC R/L 2020 X11-A	20	20	120	20	VC.. 1103...

Ersatzteile / Spare parts / Комплектующие

Für Halter For holder Для державки	Schraube Screw Винт	Schlüssel Key Ключ
SVXC R/L... X11-A	SS 1751	KS 1751

Hinweis: Auflage- und Anlageflächen geschliffen.
 Remark: All flats ground.
 Примечание: Все поверхности шлифованные.

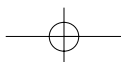



Set Drehmoment - Schraubendreher
Set Torque screwdriver
Наборы динамометрических отвёрток

1



Set 1

Einstellbereich von **0,6 Nm bis 1,5 Nm** / Adjustable from 0,6 Nm to 1,5 Nm / С регулировкой от 0,6 Nm до 1,5 Nm.

- | | | |
|---|--|---|
| 1 Drehmoment - Schraubendreher | 1 Torque screwdriver | 1 Динамометрическая отвёртка |
| je 1 Hochleistungsklinge Torx T6; Torx T7; Torx T8 und Torx T9 | 1 each bits Torx T6, Torx T7, Torx T8 and Torx T9 | 1 Набор сменных бит Torx T6, Torx T7, Torx T8, Torx T9 |
| 1 Einstellschlüssel | 1 Adjustment key | 1 Регулировочный ключ |

(Bestellbezeichnung: **Set-Drehmoment 1**)

(Ordering code: **Set-Torque 1**)

В заказе указать: **Набор динамометрических отвёрток №1)**

Set 2

Einstellbereich von **1,5 Nm bis 3,0 Nm** / Adjustable from 1,5 Nm to 3,0 Nm / С регулировкой от 1,5 Nm до 3,0 Nm

- | | | |
|--|---|--|
| 1 Drehmoment - Schraubendreher | 1 Torque screwdriver | 1 Динамометрическая отвёртка |
| je 1 Hochleistungsklinge Torx T9; Torx T10 und Torx T15 | 1 each bits Torx T9, Torx T10 and Torx T15 | 1 Набор сменных бит Torx T9, Torx T10, Torx T15 |
| 1 Einstellschlüssel | 1 Adjustment key | 1 Регулировочный ключ |

(Bestellbezeichnung: **Set-Drehmoment 2**)

(Ordering code: **Set-Torque 2**)

В заказе указать: **Набор динамометрических отвёрток №2)**

Set 3

Einstellbereich von **3,0 Nm bis 5,4 Nm** / Adjustable from 3,0 Nm to 5,4 Nm / С регулировкой от 3,0 Nm до 5,4 Nm

- | | | |
|---|--|---|
| 1 Drehmoment - Schraubendreher | 1 Torque screwdriver | 1 Динамометрическая отвёртка |
| je 1 Hochleistungsklinge Torx T10; Torx T15 und Torx T20 | 1 each bits Torx T10, Torx T15 and Torx T20 | 1 Набор сменных бит Torx T10, Torx T15, Torx T20 |
| 1 Einstellschlüssel | 1 Adjustment key | 1 Регулировочный ключ |

(Bestellbezeichnung: **Set-Drehmoment 3**)

(Ordering code: **Set-Torque 3**)

В заказе указать: **Набор динамометрических отвёрток №2)**

Zulässige Anzugsmomente **für Wendeschneidplatten** - Spannelemente / Recommended torque settings **for inserts** /
 Рекомендуемые моменты зажима сменных пластин

Gewinde Thread Резьба	Torx - Größe Torx size Торх - Размер	Anzugsmoment Torque Момент
M2	T6	0,6 Nm
M2,2	T7	1,0 Nm
M2,5	T8	1,3 Nm
M3	T9	2,2 Nm
M3,5	T10	3,4 Nm
M4	T15	5,1 Nm

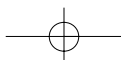





Innenbearbeitung Internal machining Внутренняя обработка

1

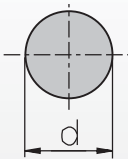
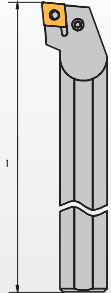
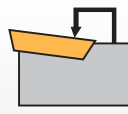
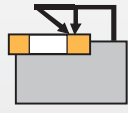
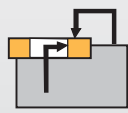
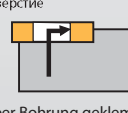

1

<p>A Stahlschaft mit Kühlbohrung. Steel shank with coolant. Стальная державка с отверстием для подачи СОЖ.</p> <p>B Stahlschaft mit Dämpfung. Steel shank with vibration clamping. Антивибрационная стальная державка</p> <p>C Hartmetallschaft mit Stahlkopf. Carbide shank with steel head. Твёрдосплавная державка со стальным наконечником</p> <p>E Hartmetallschaft mit Stahlkopf und Kühlbohrung. Carbide shank with steel head and coolant. Твёрдосплавная державка со стальным наконечником и отверстием для подачи СОЖ</p> <p>S Stahlschaft. Steel shank. Стальной хвостовик</p>			 <p>Von oben geklemmt Top clamping Прижим сверху</p>  <p>Von oben und über Bohrung geklemmt Top and hole clamping Прижим повышенной жесткости</p>  <p>Von oben und über Bohrung geklemmt Top and hole clamping Прижим сверху и поджим за отверстие</p>  <p>Über Bohrung geklemmt Hole clamping Прижим рычагом за отверстие</p>  <p>Durch Bohrung aufgeschraubt With screw through hole Закрепление винтом</p>	<p>80° C</p> <p>55° D</p> <p>75° E</p> <p>86° M</p> <p>35° V</p> <p>85° A</p> <p>82° B</p> <p>55° K</p> <p>H</p> <p>L</p> <p>O</p> <p>P</p> <p>R</p> <p>S</p> <p>T</p> <p>W</p>																																			
				<table border="1"> <thead> <tr> <th>d [mm]</th> <th>l₁ [mm]</th> <th>l₁ [mm]</th> </tr> </thead> <tbody> <tr> <td>08</td> <td>A 32</td> <td>M 150</td> </tr> <tr> <td>10</td> <td>B 40</td> <td>N 160</td> </tr> <tr> <td>12</td> <td>C 50</td> <td>P 170</td> </tr> <tr> <td>16</td> <td>D 60</td> <td>Q 180</td> </tr> <tr> <td>20</td> <td>E 70</td> <td>R 200</td> </tr> <tr> <td>25</td> <td>F 80</td> <td>S 250</td> </tr> <tr> <td>32</td> <td>G 90</td> <td>T 300</td> </tr> <tr> <td>40</td> <td>H 100</td> <td>U 350</td> </tr> <tr> <td>50</td> <td>J 110</td> <td>V 400</td> </tr> <tr> <td>60</td> <td>K 125</td> <td>W 450</td> </tr> <tr> <td></td> <td>L 140</td> <td>Y 500</td> </tr> <tr> <td></td> <td colspan="2">Sonderlänge Special length ⇄ X Специальная длина</td> </tr> </tbody> </table>	d [mm]	l ₁ [mm]	l ₁ [mm]	08	A 32	M 150	10	B 40	N 160	12	C 50	P 170	16	D 60	Q 180	20	E 70	R 200	25	F 80	S 250	32	G 90	T 300	40	H 100	U 350	50	J 110	V 400	60	K 125	W 450		L 140
d [mm]	l ₁ [mm]	l ₁ [mm]																																					
08	A 32	M 150																																					
10	B 40	N 160																																					
12	C 50	P 170																																					
16	D 60	Q 180																																					
20	E 70	R 200																																					
25	F 80	S 250																																					
32	G 90	T 300																																					
40	H 100	U 350																																					
50	J 110	V 400																																					
60	K 125	W 450																																					
	L 140	Y 500																																					
	Sonderlänge Special length ⇄ X Специальная длина																																						
S	32	U	P	C																																			
Schaftausführung Type of shank Тип оправки	Schaft-Ø Shank-Ø Диаметр оправки	Halterlänge Length Длина оправки	Klemmsystem Clamping method Система крепления	Plattenform Shape Форма пластины																																			



ISO-Bezeichnungssystem für Klemmhalter
 ISO designation system for toolholder
 Система обозначений ISO державок для внутренней обработки

				<p>Für besondere Produktmerkmale kann an der 10. Stelle ein firmeninterner Code angeführt werden.</p> <p>Special product information can be indicated by an internal company coding system at the 10th position.</p> <p>Дополнительную информацию изготовитель может заложить в соответствие с внутренней системой кодирования на 10-ой позиции</p>																																				
					<table border="1"> <thead> <tr> <th colspan="4">d</th> </tr> <tr> <th colspan="4">[mm]</th> </tr> </thead> <tbody> <tr><td>06</td><td></td><td></td><td></td></tr> <tr><td>08</td><td></td><td></td><td></td></tr> <tr><td>10</td><td></td><td></td><td></td></tr> <tr><td>12</td><td></td><td></td><td></td></tr> <tr><td>16</td><td></td><td></td><td></td></tr> <tr><td>20</td><td></td><td></td><td></td></tr> <tr><td>25</td><td></td><td></td><td></td></tr> <tr><td>32</td><td></td><td></td><td></td></tr> </tbody> </table>	d				[mm]				06				08				10				12				16				20				25		
d																																								
[mm]																																								
06																																								
08																																								
10																																								
12																																								
16																																								
20																																								
25																																								
32																																								
L	N	L	12	...																																				
Halterform Style Тип державки	Freiwinkel Clearance angle Задний угол	Halterausführung Holder execution Исполнение	Schneidlänge Edge length Длина режущей кромки	Zusatzangabe Additional coding system Дополнительная информация																																				

1



Innenbearbeitung - Übersicht

Internal machining - Program overview

Внутренняя обработка - обзор программы

1

Schraubenklammerung - positiv
Screw clamping - positive
Прижим сверху - позитивные

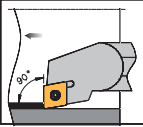
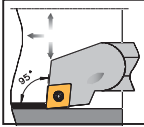
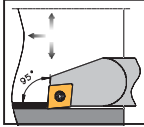
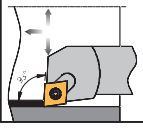
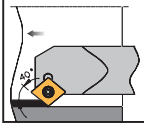
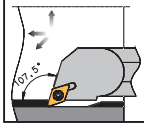
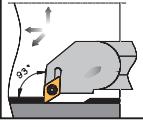
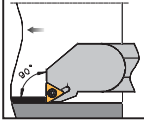
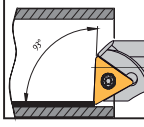
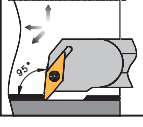
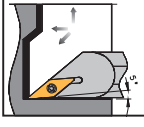
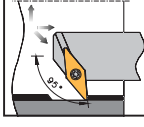
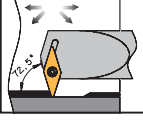
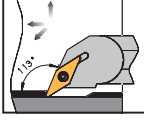
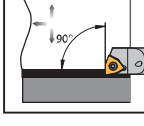
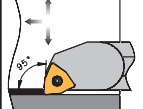
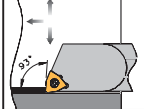
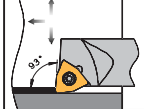
	SCFC R/L Seite Page 1.23 Страница		SCLC R/L Seite Page 1.24 Страница		SCLD R/L Seite Page 1.25 / Страница 1.26
	SCUP R/L Seite Page 1.27 Страница		SCXP R/L Seite Page 1.28 Страница		SDQC R/L Seite Page 1.29 Страница
	SDUC R/L Seite Page 1.30 Страница		STFC R/L Seite Page 1.31 / Страница 1.32		STUC R/L Seite Page 1.33 Страница
	SVLC R/L Seite Page 1.34 Страница		SVOC R/L Seite Page 1.35 Страница		SV95C R/L Seite Page 1.36 Страница
	S-SVVC R/L Seite Page 1.37 Страница		S-SVXC R/L Seite Page 1.38 Страница		A-SWFC R/L Seite Page 1.39 Страница
	S-SWLC R/L Seite Page 1.40 Страница		E-SWUC R/L Seite Page 1.41 Страница		S-SWUC R/L Seite Page 1.42 Страница

S = Stahlschaft
Steel shank
Стальной хвостовик

A = Stahlschaft mit innerer Kühlmittelzufuhr
Steel shank with through tool coolant
Стальная державка с отверстием для подачи СОЖ

C = Vollhartmetallschaft
Solid carbide shank
Твёрдосплавная державка

E = Vollhartmetallschaft mit innerer Kühlmittelzufuhr
Solid carbide shank with through tool coolant
Твёрдосплавная державка с отверстием для подачи СОЖ



Klemmhalter mit Schraubenklammerung
Toolholder with screw clamping
Державки с закреплением винтом

A-SCFC R/L

Anstellwinkel / Approach angle / Угол в плане: 90°

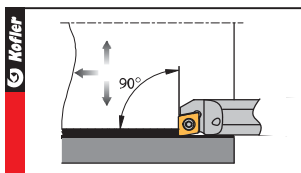

Stahlschaft mit innerer Kühlmittelzufuhr
 Steel shank with through tool coolant
 Стальная державка с отверстием для подвода СОЖ

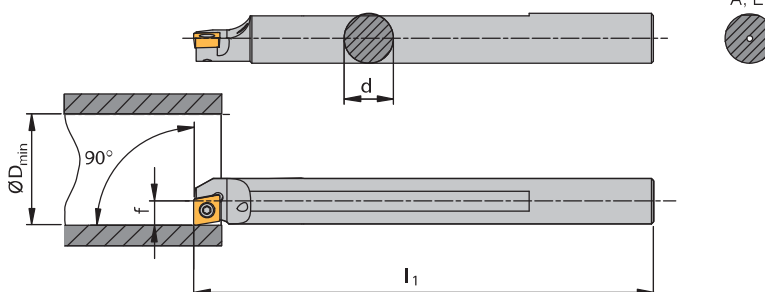

A, E



Rechte Ausführung abgebildet
 Right-hand execution shown
 Показано правостороннее исполнение

Bohrstangen / Boring bar / Державки

Bezeichnung Designation Обозначение	d	l ₁	f	D _{min}	Wendeschneidplatte Indexable insert Пластины
A 08 F SCFC R/L 06-A	8	80	4,3	8,4	CC..0602..
A 10 H SCFC R/L 06-A	10	100	5,3	10,4	CC..0602..
A 12 K SCFC R/L 06-A	12	125	6,3	12,5	CC..0602..
A 16 M SCFC R/L 09-A	16	150	8,8	16,5	CC..09T3..

Hinweis: A-Ausführung im hinteren Schaftbereich zylindrisch

/ Remark: A-execution with cylindrical part at the end of the shank

Примечание: Исполнение «А» имеет цилиндрическую форму на всей длине державки.

E-SCFC R/L

Vollhartmetallschaft mit innerer Kühlmittelzufuhr
 Solid carbide shank with through tool coolant
 Стальная державка с отверстием для подвода СОЖ

Bohrstangen / Boring bar / Державки

Bezeichnung Designation Обозначение	d	l ₁	f	D _{min}	Wendeschneidplatte Indexable insert Пластины
E 08 H SCFC R/L 06-A	8	100	4,3	8,4	CC..0602..
E 10 K SCFC R/L 06-A	10	125	5,3	10,4	CC..0602..
E 12 Q SCFC R/L 06-A	12	180	6,3	12,5	CC..0602..
E 16 R SCFC R/L 09-A	16	200	8,8	16,5	CC..09T3..

Ersatzteile / Spare parts / Комплекующие

Für Bohrstange For boring bar Для державки	Unterlage Support pad Опорная пластина	Büchse Bush Винт опорной пластины	Schraube Screw Винт крепления	Schlüssel Key Ключ	Sortiment Spare part set Набор комплектующих
.08 - 12. SCFC R/L 06-A	-	-	SS 1754	KS 1751	S 1754
.16 SCFC R/L 09-A	-	-	SS 1114	KS 1111	S 1114

Sortiment besteht aus: 3 Schrauben, 1 Schlüssel
 Complete set consists of: 3 Torx-screws, 1 Torx-screwdriver
 Набор комплектующих: Винт крепления - 3 штуки, Ключ - 1 штука.

Alle Abmessungen in mm
 Dimensions in mm
 Размеры указаны в мм



Klemmhalter mit Schraubenklemmung Toolholder with screw clamping Державки с закреплением винтом

S-SCLC R/L

Anstellwinkel / Approach angle /
Угол в плане: 95°

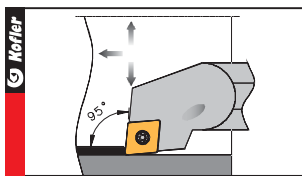

Stahlschaft
Steel shank
Стальная державка

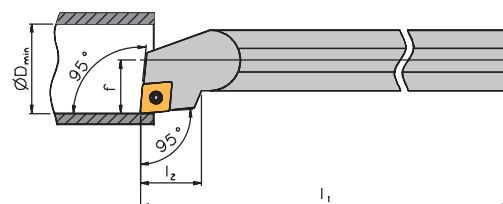
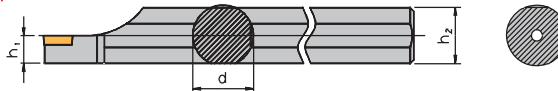

A, E



Rechte Ausführung abgebildet
Right-hand execution shown
Показано правостороннее исполнение

Bohrstangen / Boring bar / Державка

Bezeichnung Designation Обозначение	d	h ₁	h ₂	l ₁	l ₂	f	D _{min}	Wendeschneidplatte Indexable insert Пластины
S 08 H SCLC R/L 06	8	3,5	7	100	–	5	11,0	CC..0602..
S 10 K SCLC R/L 06	10	4,5	9	125	10	7	13,0	CC..0602..
S 12 Q SCLC R/L 06	12	5,5	11	180	10	9	16,0	CC..0602..
S 16 R SCLC R/L 09	16	7,5	15	200	16	11	20,0	CC..09T3..

A-SCLC R/L

Stahlschaft mit innerer Kühlmittelzufuhr
Steel shank with through tool coolant
Стальная державка с отверстием для подвода СОЖ

Bohrstangen / Boring bar / Державки

Bezeichnung Designation Обозначение	d	h ₁	h ₂	l ₁	l ₂	f	D _{min}	Wendeschneidplatte Indexable insert Пластины
A 08 F SCLC R/L 06	8	4,0	7,5	80	–	5	11,0	CC..0602..
A 10 H SCLC R/L 06	10	5,0	9,5	100	10	7	13,0	CC..0602..
A 12 K SCLC R/L 06	12	6,0	11,5	125	10	9	16,0	CC..0602..
A 16 M SCLC R/L 09	16	8,0	15,5	150	16	11	20,0	CC..09T3..

Hinweis: A-Ausführung im hinteren Schaftbereich zylindrisch / Remark: A-execution with cylindrical part at the end of the shank / Примечание: Исполнение «А» имеет цилиндрическую форму на всей длине державки.

E-SCLC R/L

Vollhartmetallschaft mit innerer Kühlmittelzufuhr
Solid carbide shank with through tool coolant
Стальная державка с отверстием для подвода СОЖ

Bohrstangen / Boring bar / Державки

Bezeichnung Designation Обозначение	d	h ₁	h ₂	l ₁	l ₂	f	D _{min}	Wendeschneidplatte Indexable insert Пластины
E 08 H SCLC R/L 06	8	4,0	7,5	100	–	5	11,0	CC..0602..
E 10 K SCLC R/L 06	10	5,0	9,5	125	10	7	14,0	CC..0602..
E 12 Q SCLC R/L 06	12	6,0	11,5	180	10	9	17,0	CC..0602..
E 16 R SCLC R/L 09	16	8,0	15,5	200	16	11	21,0	CC..09T3..

Ersatzteile / Spare parts / Комплекующие

Für Bohrstange For boring bar Для державки	Unterlage Support pad Опорная пластина	Büchse Bush Винт опорной пластины	Schraube Screw Винт крепления	Schlüssel Key Ключ	Sortiment [Ⓢ] Spare part set Набор комплектующих
.08 - 12. SCLC R/L 06	–	–	SS 1754	KS 1751	S 1754
.16 - 20. SCLC R/L 09	–	–	SS 1114	KS 1111	S 2314

[Ⓢ] Sortiment besteht aus: 3 Schrauben, 1 Schlüssel und je nach Haltertyp 1 Unterlage, 1 Büchse.
Complete set consists of: 3 Torx-screws, 1 Torx-screwdriver and depending on type of toolholder 1 support pad, 1 bush.
Набор комплектующих: Винт крепления - 3 штуки, Ключ - 1 штука.

Alle Abmessungen in mm
Dimensions in mm
Размеры указаны в мм



Klemmhalter mit Schraubenklemmung
Toolholder with screw clamping
Державки с закреплением винтом

S-SCLD R/L

Anstellwinkel / Approach angle /
 Угол в плане: 95°

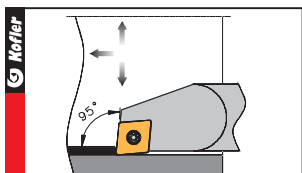

Stahlschaft
 Steel shank
 Стальная державка

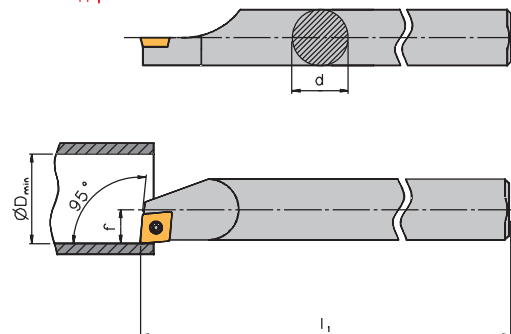

A, E



Rechte Ausführung abgebildet
 Right-hand execution shown
 Показано правостороннее исполнение

Bohrstangen / Boring bar / Barenó

Bezeichnung Designation Обозначение	d	l ₁	l ₂	f	D _{min}	Wendeschneidplatte Indexable insert Пластины
S 04 E SCLD R/L 04	4	70	-	2,4	4,8	CD.. 0401..
S 05 E SCLD R/L 04	5	70	-	2,9	5,8	CD.. 0401..
S 06 F SCLD R/L 04	6	80	-	3,4	6,8	CD.. 0401..

A-SCLD R/L

Stahlschaft mit innerer Kühlmittelzufuhr
 Steel shank with through tool coolant
 Стальная державка с отверстием для подвода СОЖ

Bohrstangen / Boring bar / Державки

Bezeichnung Designation Обозначение	d	l ₁	l ₂	f	D _{min}	Wendeschneidplatte Indexable insert Пластины
A 04 E SCLD R/L 04	4	70	-	2,4	4,8	CD.. 0401..
A 05 E SCLD R/L 04	5	70	-	2,9	5,8	CD.. 0401..
A 06 F SCLD R/L 04	6	80	-	3,4	6,8	CD.. 0401..

E-SCLD R/L

Vollhartmetallschaft mit innerer Kühlmittelzufuhr
 Solid carbide shank with through tool coolant
 Стальная державка с отверстием для подвода СОЖ

Bohrstangen / Boring bar / Державки

Bezeichnung Designation Обозначение	d	l ₁	l ₂	f	D _{min}	Wendeschneidplatte Indexable insert Пластины
E 04 F SCLD R/L 04	4	80	-	2,4	4,8	CD.. 0401..
E 05 F SCLD R/L 04	5	80	-	2,9	5,8	CD.. 0401..
E 06 G SCLD R/L 04	6	95	-	3,4	6,8	CD.. 0401..

Ersatzteile / Spare parts / Комплекующие

Für Bohrstange For boring bar Для державки	Schraube Screw Винт крепления	Schlüssel Key Ключ
...SCLD R/L 04	T 1,8.03	KS 1886





Klemmhalter mit Schraubenklammer
Toolholder with screw clamping
Державки с закреплением винтом

1

S-SCLD R/L

Anstellwinkel / Approach angle / Угол в плане 95°

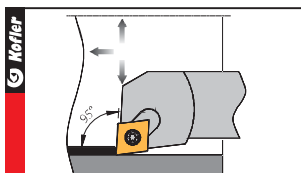

Mit abgesetztem Stahlschaft
 Reinforced steel shank
 Стальная державка

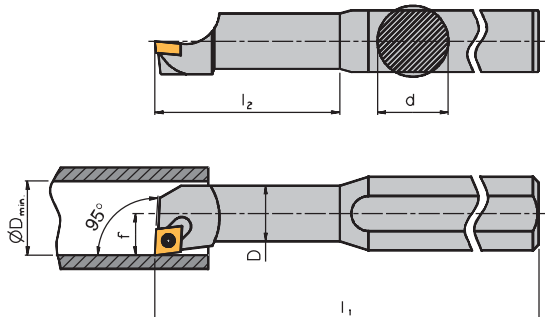

A, E

Rechte Ausführung abgebildet
 Right-hand execution shown
 Показано правостороннее исполнение

Bohrstangen / Boring bar / Державка

Bezeichnung Designation Обозначение	d	D	l ₁	l ₂	f	D _{min}	Wendeschneidplatte Indexable insert Пластины
S 0408 H SCLD R/L 04	8	4	100	16	2,4	4,8	CD.. 0401..
S 0508 H SCLD R/L 04	8	5	100	20	2,9	5,8	CD.. 0401..
S 0608 H SCLD R/L 04	8	6	100	24	3,4	6,8	CD.. 0401..

A-SCLD R/L

Mit abgesetztem Stahlschaft und innerer Kühlmittelzufuhr
 Reinforced steel shank with through tool coolant
 Стальная державка с отверстием для подвода СОЖ

Bohrstangen / Boring bar / Державка

Bezeichnung Designation Обозначение	d	D	l ₁	l ₂	f	D _{min}	Wendeschneidplatte Indexable insert Пластины
A 0408 H SCLD R/L 04	8	4	100	16	2,4	4,8	CD.. 0401..
A 0508 H SCLD R/L 04	8	5	100	20	2,9	5,8	CD.. 0401..
A 0608 H SCLD R/L 04	8	6	100	24	3,4	6,8	CD.. 0401..

E-SCLD R/L

Mit abgesetztem Vollhartmetallschaft und innerer Kühlmittelzufuhr
 Reinforced solid carbide shank with through tool coolant
 Стальная державка с отверстием для подвода СОЖ

Bohrstangen / Boring bar / Державка

Bezeichnung Designation Обозначение	d	D	l ₁	l ₂	f	D _{min}	Wendeschneidplatte Indexable insert Пластины
E 0408 H SCLD R/L 04	8	4	100	24	2,4	4,8	CD.. 0401..
E 0508 H SCLD R/L 04	8	5	100	30	2,9	5,8	CD.. 0401..
E 0608 H SCLD R/L 04	8	6	100	36	3,4	6,8	CD.. 0401..

Ersatzteile / Spare parts / Комплекующие

Für Bohrstange For boring bar Для державки	Schraube Screw Винт крепления	Schlüssel Key Ключ
... SCLD R/L 04	T1,8.03	KS 2505

Achtung: Rechter Halter → Linke Wendeschneidplatte, Linker Halter → Rechte Wendeschneidplatte
 Attention: Holder right hand design → Left-hand indexable insert, Holder left hand design → Right-hand indexable insert
 Внимание: Правосторонняя державка → левосторонняя пластина, Левосторонняя державка → правосторонняя пластина



Klemmhalter mit Schraubenklammerung
Toolholder with screw clamping
Державки с закреплением винтом

S-SCUP R/L

Anstellwinkel / Approach angle /
 Угол в плане: 93°

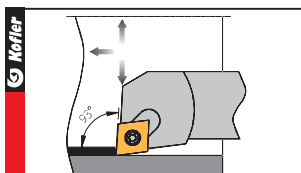

Mit abgesetztem Stahlschaft
 Reinforced steel shank
 Стальная державка

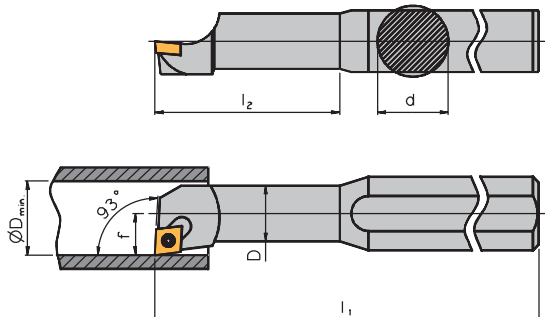

Rechte Ausführung abgebildet
 Right-hand execution shown
 Показано правостороннее исполнение

Bohrstangen / Boring bar / Державки

Bezeichnung Designation Обозначение	d	D	l ₁	l ₂	f	D _{min}	Wendeschneidplatte Indexable insert Пластины
S 0608 H SCUP R/L 05	8	6	100	20	4,5	8	CP.05T1..
S 0810 J SCUP R/L 05	10	8	110	26	6,0	11	CP.05T1..
S 1012 K SCUP R/L 05	12	10	125	32	7,0	13	CP.05T1..
S 1216 M SCUP R/L 05	16	12	150	40	9,0	16	CP.05T1..

A-SCUP R/L

Mit abgesetztem Stahlschaft und innerer Kühlmittelzufuhr
 Reinforced steel shank with through tool coolant
 Стальная державка с отверстием для подвода СОЖ

Bohrstangen / Boring bar / Державки

Bezeichnung Designation Обозначение	d	D	l ₁	l ₂	f	D _{min}	Wendeschneidplatte Indexable insert Пластины
A 0608 H SCUP R/L 05	8	6	100	20	4,5	8	CP.05T1..
A 0810 J SCUP R/L 05	10	8	110	26	6,0	11	CP.05T1..
A 1012 K SCUP R/L 05	12	10	125	32	7,0	13	CP.05T1..
A 1216 M SCUP R/L 05	16	12	150	40	9,0	16	CP.05T1..

E-SCUP R/L

Mit abgesetztem Vollhartmetallschaft und innerer Kühlmittelzufuhr
 Reinforced solid carbide shank with through tool coolant
 Стальная державка с отверстием для подвода СОЖ

Bohrstangen / Boring bar / Державки

Bezeichnung Designation Обозначение	d	D	l ₁	l ₂	f	D _{min}	Wendeschneidplatte Indexable insert Пластины
E 0608 H SCUP R/L 05	8	6	100	28	4,5	8	CP.05T1..
E 0810 J SCUP R/L 05	10	8	110	36	6,0	11	CP.05T1..
E 1012 K SCUP R/L 05	12	10	125	44	7,0	13	CP.05T1..
E 1216 M SCUP R/L 05	16	12	150	55	9,0	16	CP.05T1..

Ersatzteile / Spare parts / Комплекующие

Für Bohrstange For boring bar Для державок	Schraube Screw Винт крепления	Schlüssel Key Ключ
... SCUP R/L 05	T 2,2.04	KS 5151

Achtung: Rechter Halter → Linke Wendeschneidplatte, Linker Halter → Rechte Wendeschneidplatte
 Attention: Holder right hand design → Left-hand indexable insert, Holder left hand design → Right-hand indexable insert
 Внимание: Правосторонняя державка → левосторонняя пластина, Левосторонняя державка → правосторонняя пластина





Klemmhalter mit Schraubenklammerung
Toolholder with screw clamping
Державки с закреплением винтом

1

S-SCXP R/L

Anstellwinkel / Approach angle / Угол в плане: 40°

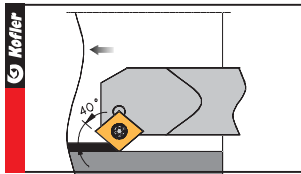

Mit abgesetztem Stahlschaft
 Reinforced steel shank
 Стальная державка

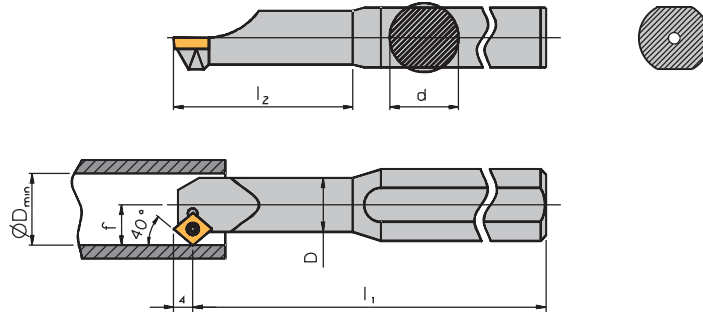

Rechte Ausführung abgebildet
 Right-hand execution shown
 Показано правостороннее исполнение

Bohrstangen / Boring bar / Державки

Bezeichnung Designation Обозначение	d	D	l ₁	l ₂	f	D _{min}	Wendeschneidplatte Indexable insert Пластины
S 0608 H SCXP R/L 05	8	6	100	20	4,5	8,5	CP.05T1..
S 0810 J SCXP R/L 05	10	8	110	26	6,0	11,0	CP.05T1..
S 1012 K SCXP R/L 05	12	10	125	32	7,0	13,0	CP.05T1..
S 1216 M SCXP R/L 05	16	12	150	40	9,0	16,0	CP.05T1..

A-SCXP R/L

Mit abgesetztem Stahlschaft und innerer Kühlmittelzufuhr
 Reinforced steel shank with through tool coolant
 Стальная державка с отверстием для подвода СОЖ

Bohrstangen / Boring bar / Державки

Bezeichnung Designation Обозначение	d	D	l ₁	l ₂	f	D _{min}	Wendeschneidplatte Indexable insert пластины
A 0608 H SCXP R/L 05	8	6	100	20	4,5	8,5	CP.05T1..
A 0810 J SCXP R/L 05	10	8	110	26	6,0	11,0	CP.05T1..
A 1012 K SCXP R/L 05	12	10	125	32	7,0	13,0	CP.05T1..
A 1216 M SCXP R/L 05	16	12	150	40	9,0	16,0	CP.05T1..

E-SCXP R/L

Mit abgesetztem Vollhartmetallschaft und innerer Kühlmittelzufuhr
 Reinforced solid carbide shank with through tool coolant
 Стальная державка с отверстием для подвода СОЖ

Bohrstangen / Boring bar / Державки

Bezeichnung Designation Обозначение	d	D	l ₁	l ₂	f	D _{min}	Wendeschneidplatte Indexable insert Пластины
E 0608 H SCXP R/L 05	8	6	100	28	4,5	8,5	CP.05T1..
E 0810 J SCXP R/L 05	10	8	110	36	6,0	11,0	CP.05T1..
E 1012 K SCXP R/L 05	12	10	125	44	7,0	13,0	CP.05T1..
E 1216 M SCXP R/L 05	16	12	150	55	9,0	16,0	CP.05T1..

Ersatzteile / Spare parts / Комплекующие

Für Bohrstange For boring bar Для державок	Schraube Screw Винт крепления	Schlüssel Key Ключ
... SCXP R/L 05	T 2,2.04	KS 5151



Klemmhalter mit Schraubenklemmung
Toolholder with screw clamping
Державки с закреплением винтом

S-SDQC R/L

Anstellwinkel / Approach angle /
 Угол в плане 107,5°

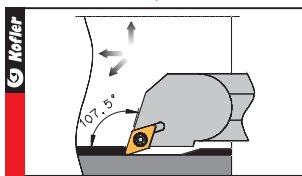

Stahlschaft
 Steel shank
 Стальная державка

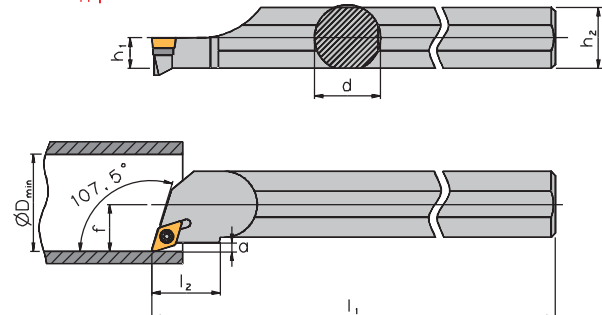

Rechte Ausführung abgebildet
 Right-hand execution shown
 Показано правостороннее исполнение

Bohrstangen / Boring bar / Державки

Bezeichnung Designation Обозначение	d	h ₁	h ₂	l ₁	l ₂	f	a	D _{min}	Wendeschneidplatte Indexable insert Пластины
S 10 K SDQC R/L 07	10	4,5	9	125	10,0	7	2,4	14,0	DC.. 0702..
S 12 Q SDQC R/L 07	12	5,5	11	180	12,5	9	2,9	17,0	DC.. 0702..
S 16 R SDQC R/L 07	16	7,5	15	200	16,5	11	2,9	21,0	DC.. 0702..

A-SDQC R/L

Stahlschaft mit innerer Kühlmittelzufuhr
 Steel shank with through tool coolant
 Стальная державка с отверстием для подвода СОЖ

Bohrstangen / Boring bar / Державки

Bezeichnung Designation Обозначение	d	h ₁	h ₂	l ₁	l ₂	f	a	D _{min}	Wendeschneidplatte Indexable insert Пластины
A 10 H SDQC R/L 07	10	4,5	9,0	100	10,0	7	2,4	14,0	DC.. 0702..
A 12 K SDQC R/L 07	12	6,0	11,5	125	12,5	9	2,9	17,0	DC.. 0702..
A 16 M SDQC R/L 07	16	8,0	15,5	150	16,5	11	2,9	21,0	DC.. 0702..

Hinweis: A-Ausführung im hinteren Schaftbereich zylindrisch

/ Remark: A-execution with cylindrical part at the end of the shank

Примечание: Исполнение «А» имеет цилиндрическую форму на всей длине державки.

E-SDQC R/L

Vollhartmetallschaft mit innerer Kühlmittelzufuhr
 Solid carbide shank with through tool coolant
 Стальная державка с отверстием для подвода СОЖ

Bohrstangen / Boring bar / Державки

Bezeichnung Designation Обозначение	d	h ₁	h ₂	l ₁	l ₂	f	a	D _{min}	Wendeschneidplatte Indexable insert Пластины
E 10 K SDQC R/L 07	10	5,0	9,5	125	10,0	7	2,4	14,0	DC.. 0702..
E 12 Q SDQC R/L 07	12	6,0	11,5	180	12,5	9	2,9	17,0	DC.. 0702..
E 16 R SDQC R/L 07	16	8,0	15,5	200	16,5	11	2,9	21,0	DC.. 0702..

Ersatzteile / Spare parts / Комплекующие

Für Bohr stang e For boring bar Для державки	Unterlage Support pad Опорная пластина	Büchse Bush Винт опорной пластины	Schraube Screw Винт крепления	Schlüssel Key Ключ	Sortiment Spare part set Набор комплектующих
10-16 ..SDQC R/L 07	-	-	SS 1751	KS 1751	S 1751

Sortiment besteht aus: 3 Schrauben, 1 Schlüssel und je nach Haltertyp 1 Unterlage, 1 Büchse.
 Complete set consists of: 3 Torx-screws, 1 Torx-screwdriver and depending on type of toolholder 1 support pad, 1 bush.
 Набор комплектующих: Винт крепления - 3 штуки, Ключ - 1 штука.

Alle Abmessungen in mm
 Dimensions in mm
 Размеры указаны в мм





Klemmhalter mit Schraubenklemmung
Toolholder with screw clamping
Державки с закреплением винтом

1

S-SDUC R/L

Anstellwinkel / Approach angle / Угол в плане: 93°

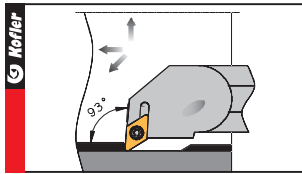

Stahlschaft
 Steel shank
 Стальная державка

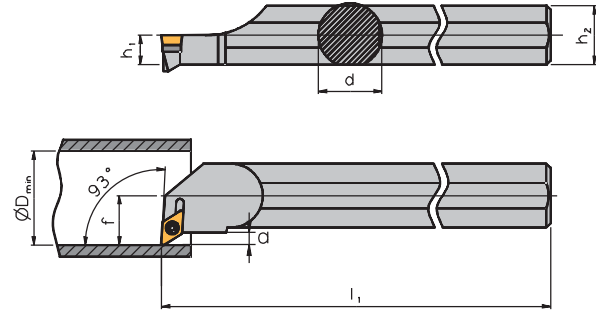

Rechte Ausführung abgebildet
 Right-hand execution shown
 Показано правостороннее исполнение

Bohrstangen / Boring bar / Державки

Bezeichnung Designation Обозначение	d	h ₁	h ₂	l ₁	f	a	D _{min}	Wendeschneidplatte Indexable insert Пластины
S 10 K SDUC R/L 07	10	4,5	9	125	7	1,9	14,0	DC.. 0702..
S 12 Q SDUC R/L 07	12	5,5	11	180	9	2,9	17,0	DC.. 0702..
S 16 R SDUC R/L 07	16	7,5	15	200	11	2,9	21,0	DC.. 0702..

A-SDUC R/L

Stahlschaft mit innerer Kühlmittelzufuhr
 Steel shank with through tool coolant
 Стальная державка с отверстием для подвода СОЖ

Bohrstangen / Boring bar / Державки

Bezeichnung Designation Обозначение	d	h ₁	h ₂	l ₁	f	a	D _{min}	Wendeschneidplatte Indexable insert Пластины
A 10 H SDUC R/L 07	10	5,0	9,5	100	7	1,9	14,0	DC.. 0702..
A 12 K SDUC R/L 07	12	6,0	11,5	125	9	2,9	17,0	DC.. 0702..
A 16 M SDUC R/L 07	16	8,0	15,5	150	11	2,9	21,0	DC.. 0702..

Hinweis: A-Ausführung im hinteren Schaftbereich zylindrisch / Remark: A-execution with cylindrical part at the end of the shank / Примечание: Исполнение «А» имеет цилиндрическую форму на всей длине державки.

E-SDUC R/L

Vollhartmetallschaft mit innerer Kühlmittelzufuhr
 Solid carbide shank with through tool coolant
 Стальная державка с отверстием для подвода СОЖ

Bohrstangen / Boring bar / Державки

Bezeichnung Designation Обозначение	d	h ₁	h ₂	l ₁	f	a	D _{min}	Wendeschneidplatte Indexable insert Пластины
E 10 K SDUC R/L 07	10	5,0	9,5	125	7	1,9	14,0	DC.. 0702..
E 12 Q SDUC R/L 07	12	6,0	11,5	180	9	2,9	17,0	DC.. 0702..
E 16 R SDUC R/L 07	16	8,0	15,5	200	11	2,9	21,0	DC.. 0702..

Ersatzteile / Spare parts / Комплекующие

Für Bohrstange For boring bar Для державки	Unterlage Support pad Опорная пластина	Büchse Bush Винт опорной пластины	Schraube Screw Винт крепления	Schlüssel Key Ключ	Sortiment Spare part set Набор комплектующих
.10 - 16. SDUC R/L 07	-	-	SS 1751	KS 1751	S 1751

Sortiment besteht aus: 3 Schrauben, 1 Schlüssel und je nach Haltertyp 1 Unterlage, 1 Büchse.
 Complete set consists of: 3 Torx-screws, 1 Torx-screwdriver and depending on type of toolholder 1 support pad, 1 bush.
 Набор комплектующих: Винт крепления - 3 штуки, Ключ - 1 штука.

Alle Abmessungen in mm
 Dimensions in mm
 Размеры указаны в мм



Klemmhalter mit Schraubenklammerung
Toolholder with screw clamping
Державки с закреплением винтом

S-STFC R/L

Anstellwinkel / Approach angle /
 Угол в плане: 90°

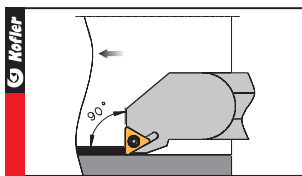

Stahlschaft
 Steel shank
 Стальная державка

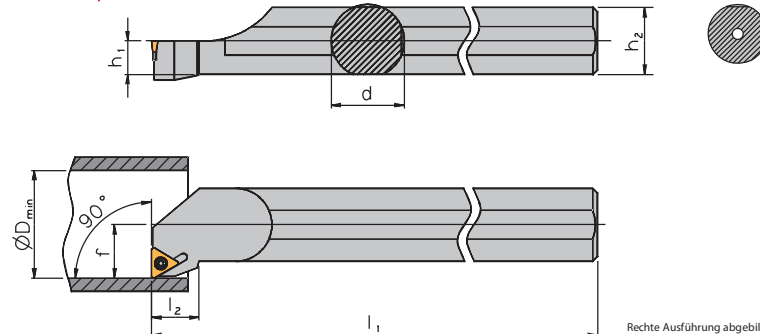

Rechte Ausführung abgebildet
 Right-hand execution shown
 Показано правостороннее исполнение

Bohrstangen / Boring bar / Державки

Bezeichnung Designation Обозначение	d	h ₁	h ₂	l ₁	l ₂	f	D _{min}	Wendeschneidplatte Indexable insert Пластини
S 10 K STFC R/L 09	10	4,5	9	125	12	7	14,0	TC.. 0902..
S 12 Q STFC R/L 11	12	5,5	11	180	13	9	17,0	TC.. 1102..
S 16 R STFC R/L 11	16	7,5	15	200	13	11	21,0	TC.. 1102..

A-STFC R/L

Stahlschaft mit innerer Kühlmittelzufuhr
 Steel shank with through tool coolant
 Стальная державка с отверстием для подвода СОЖ

Bohrstangen / Boring bar / Державки

Bezeichnung Designation Обозначение	d	h ₁	h ₂	l ₁	l ₂	f	D _{min}	Wendeschneidplatte Indexable insert Плвстины
A 10 H STFC R/L 09	10	5,0	9,5	100	12	7	14,0	TC.. 0902..
A 12 K STFC R/L 11	12	6,0	11,5	125	13	9	17,0	TC.. 1102..
A 16 M STFC R/L 11	16	8,0	15,5	150	13	11	21,0	TC.. 1102..

Hinweis: A-Ausführung im hinteren Schaftbereich zylindrisch

/ Remark: A-execution with cylindrical part at the end of the shank

Примечание: Исполнение «А» имеет цилиндрическую форму на всей длине державки.

Ersatzteile / Spare parts / Комплекующие

Für Bohrstange For boring bar Для державки	Unterlage Support pad Опорная пластина	Büchse Bush Винт опорной пластины	Schraube Screw Винт крепления	Schlüssel Key Ключ	Sortiment [Ⓢ] Spare part set Набор комплектующих
.10. STFC R/L 09	–	–	SS 5151	KS 5151	S 5151
.12- 16. STFC R/L 11	–	–	SS 1751	KS 1751	S 1751

[Ⓢ] Sortiment besteht aus: 3 Schrauben, 1 Schlüssel und je nach Haltertyp 1 Unterlage, 1 Büchse.
 Complete set consists of: 3 Torx-screws, 1 Torx-screwdriver and depending on type of toolholder 1 support pad, 1 bush.
 Набор комплектующих: Винт крепления - 3 штуки, Ключ - 1 штука.

Alle Abmessungen in mm
 Dimensions in mm
 Размеры указаны в мм





Klemmhalter mit Schraubenklemmung
Toolholder with screw clamping
Державки с закреплением винтом

A-STFC R/L

Anstellwinkel / Approach angle /
 Угол в плане: 90°

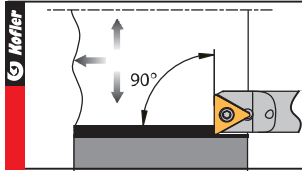

Stahlschaft mit innerer Kühlmittelzufuhr
 Steel shank with through tool coolant
 Стальная державка с отверстием для подвода СОЖ

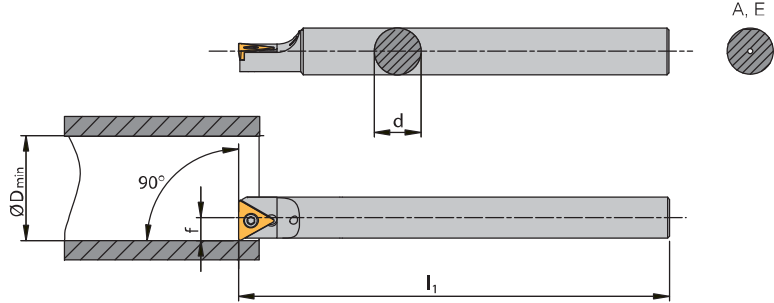

Rechte Ausführung abgebildet
 Right-hand execution shown
 Показано правостороннее исполнение

Bohrstangen / Boring bar / Державки

Bezeichnung Designation Обозначение	d	l ₁	f	D _{min}	Wendeschneidplatte Indexable insert Пластины
A 08 F STFC R/L 06-A	8	80	4,3	8,4	TC.. 06T1..
A 10 H STFC R/L 09-A	10	100	5,3	10,4	TC.. 0902..
A 12 K STFC R/L 11-A	12	125	6,3	12,5	TC.. 1102..
A 16 M STFC R/L 11-A	16	150	8,8	16,5	TC.. 1102..

Hinweis: A-Ausführung im hinteren Schaftbereich zylindrisch

/ Remark: A-execution with cylindrical part at the end of the shank

Примечание: Исполнение «А» имеет цилиндрическую форму на всей длине державки.

E-STFC R/L

Vollhartmetallschaft mit innerer Kühlmittelzufuhr
 Solid carbide shank with through tool coolant
 Стальная державка с отверстием для подвода СОЖ

Bohrstangen / Boring bar / Державки

Bezeichnung Designation Обозначение	d	l ₁	f	D _{min}	Wendeschneidplatte Indexable insert Пластины
E 08 H STFC R/L 06-A	8	100	4,3	8,4	TC.. 06T1..
E 10 K STFC R/L 09-A	10	125	5,3	10,4	TC.. 0902..
E 12 Q STFC R/L 11-A	12	180	6,3	12,5	TC.. 1102..
E 16 R STFC R/L 11-A	16	200	8,8	16,5	TC.. 1102..

Ersatzteile / Spare parts / Комплектующие

Für Bohrstange For boring bar Для державки	Unterlage Support pad Опорная пластина	Büchse Bush Винт опорной пластины	Schraube Screw Винт крепления	Schlüssel Key Ключ	Sortiment ④ Spare part set Набор комплектующих
.08. STFC R/L 06-A	-	-	SS5140	KS1886	-
.10. STFC R/L 09-A	-	-	SS5151	KS5151	S5151
.12 - 16. STFC R/L 11-A	-	-	SS1751	KS1751	S1751

④ Sortiment besteht aus: 3 Schrauben, 1 Schlüssel
 Complete set consists of: 3 Torx-screws, 1 Torx-screwdriver
 Набор комплектующих: Винт крепления - 3 штуки, Ключ - 1 штука.



Klemmhalter mit Schraubenklemmung
Toolholder with screw clamping
Державки с закреплением винтом

S-STUC R/L

Anstellwinkel / Approach angle /
 Угол в плане: 93°

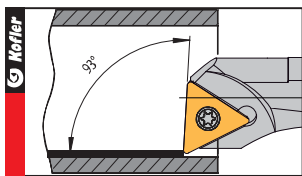

Stahlschaft
 Steel shank
 Стальная державка

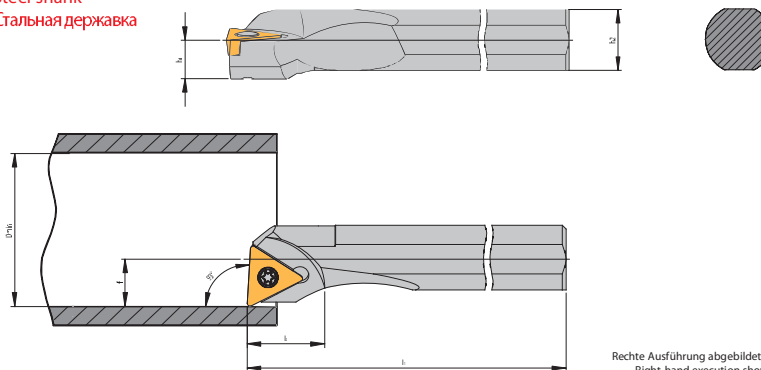

Rechte Ausführung abgebildet
 Right-hand execution shown
 Показано правостороннее исполнение

Bohrstangen / Boring bar / Державки

Bezeichnung Designation Обозначение	d	h ₁	h ₂	l ₁	l ₂	f	D _{min}	Wendeschneidplatte Indexable insert Пластини
S 10 K STUC R/L 09	10	4,5	9	125	11,3	6,9	12,5	TC.. 0902..
S 12 Q STUC R/L 11	12	5,5	11	180	13,9	8,9	16,0	TC.. 1102..
S 16 R STUC R/L 16	16	7,5	15	200	23,4	10,9	21,0	TC.. 16T3..

A-STUC R/L

Stahlschaft mit innerer Kühlmittelzufuhr
 Steel shank with through tool coolant
 Стальная державка с отверстием для подвода СОЖ

Bohrstangen / Boring bar / Державки

Bezeichnung Designation Обозначение	d	h ₁	h ₂	l ₁	l ₂	f	D _{min}	Wendeschneidplatte Indexable insert Пластини
A 08 F STUC R 06	8	4,5	7,5	80	6,0	4,9	11,0	TC.. 06T1..
A 10 H STUC R/L 09	10	4,5	9,0	100	11,3	6,9	12,5	TC.. 0902..
A 12 K STUC R/L 11	12	5,5	11,0	125	13,9	8,9	16,0	TC.. 1102..
A 16 M STUC R/L 16	16	7,5	15,0	150	23,4	10,9	21,0	TC.. 16T3..

Ersatzteile / Spare parts / Комплектующие

Für Bohrstange For boring bar Для державки	Unterlage Support pad Опорная пластина	Büchse Bush Винт опорной пластины	Schraube Screw Винт крепления	Schlüssel Key Ключ	Sortiment ① Spare part set Набор комплектующих
A 08 F STUC R 06	–	–	SS5140	KS1886	–
S 10 K STUC R/L 09	–	–	SS5151	KS5151	S 5151
S 12 Q STUC R/L 11	–	–	SS1751	KS1751	S 1751
S 16 R STUC R/L 16	–	–	SS1114	KS1111	S 1114

① Sortiment besteht aus: 3 Schrauben, 1 Schlüssel und je nach Haltertyp 1 Unterlage, 1 Büchse.
 Complete set consists of: 3 Torx-screws, 1 Torx-screwdriver and depending on type of toolholder 1 support pad, 1 bush.
 Набор комплектующих: Винт крепления - 3 штуки, Ключ - 1 штука.





Klemmhalter mit Schraubenklammerung
Toolholder with screw clamping
Державки с закреплением винтом

1

S-SVLC R/L

Anstellwinkel / Approach angle /
 Угол в плане: 95°

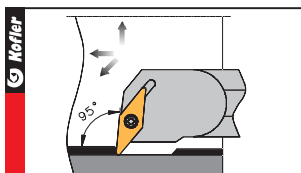

Stahlschaft
 Steel shank
 Стальная державка

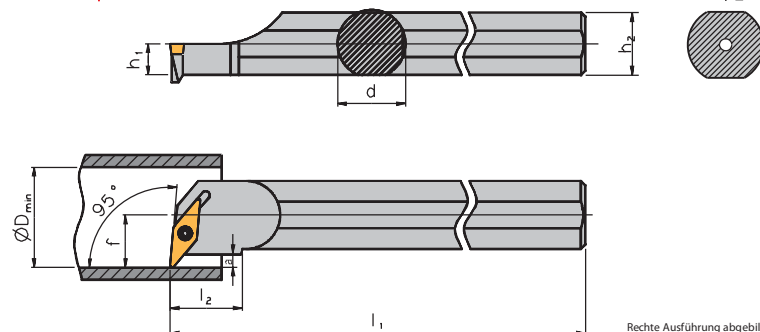

Rechte Ausführung abgebildet
 Right-hand execution shown
 Показано правостороннее исполнение

Bohrstangen / Boring bar / Державки

Bezeichnung Designation Обозначение	d	a	l ₁	l ₂	f	D _{min}	Wendeschneidplatte Indexable insert Пластины
S 10 H SVLC R/L 07	10	5	100	22	7	12,5	VC.. 0702..
S 12 K SVLC R/L 07	12	6	125	28	9	15,5	VC.. 0702..
S 16 M SVLC R/L 07	16	5	150	36	11	19,5	VC.. 0702..

A-SVLC R/L

Stahlschaft mit innerer Kühlmittelzufuhr
 Steel shank with through tool coolant
 Стальная державка с отверстием для подвода СОЖ

Bohrstangen / Boring bar / Державки

Bezeichnung Designation Обозначение	d	a	l ₁	l ₂	f	D _{min}	Wendeschneidplatte Indexable insert Пластины
A 10 H SVLC R/L 07	10	5	100	22	7	12,5	VC.. 0702..
A 12 K SVLC R/L 07	12	6	125	28	9	15,5	VC.. 0702..
A 16 M SVLC R/L 07	16	5	150	36	11	19,5	VC.. 0702..

E-SVLC R/L

Vollhartmetallschaft mit innerer Kühlmittelzufuhr
 Solid carbide shank with through tool coolant
 Стальная державка с отверстием для подвода СОЖ

Bohrstangen / Boring bar / Державки

Bezeichnung Designation Обозначение	d	a	l ₁	l ₂	f	D _{min}	Wendeschneidplatte Indexable insert Пластины
E 10 H SVLC R/L 07	10	5	100	32	7	12,5	VC.. 0702..
E 12 K SVLC R/L 07	12	6	125	40	9	15,5	VC.. 0702..
E 16 M SVLC R/L 07	16	5	150	55	11	19,5	VC.. 0702..

Ersatzteile / Spare parts / Комплекующие

Für Bohrstange For boring bar Для державки	Schraube Screw Винт крепления	Schlüssel Key Ключ
...SVLC R/L 07	SS 5140	KS 1886

Achtung: Rechter Halter → Linke Wendeschneidplatte,
 Attention: Holder right hand design → Left-hand indexable insert,
 Внимание: Правосторонняя державка → левосторонняя пластина,
 Linker Halter → Rechte Wendeschneidplatte,
 Holder left hand design → Right-hand indexable insert
 Левосторонняя державка → Правосторонняя пластина



Klemmhalter mit Schraubenklammerung
Toolholder with screw clamping
Державки с закреплением винтом

A-SVOC R/L

Anstellwinkel / Approach angle /
 Угол в плане: 95°

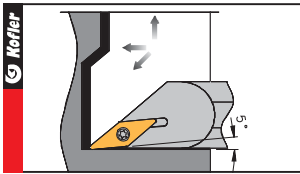

Stahlschaft mit innerer Kühlmittelzufuhr
 Steel shank with through tool coolant
 Стальная державка с отверстием для подвода СОЖ

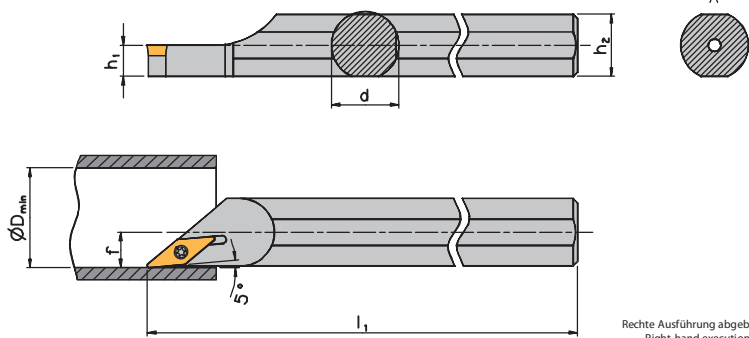

Rechte Ausführung abgebildet
 Right-hand execution shown
 Показано правостороннее исполнение

Bohrstangen / Boring bar / Державки

Bezeichnung Designation Обозначение	d	a	l ₁	l ₂	f	D _{min}	Wendeschneidplatte Indexable insert Пластины
A 10 H SVOC R/L 07	10	-	100	-	5,5	13	VC.. 0702..
A 12 K SVOC R/L 07	12	-	125	-	6,5	13	VC.. 0702..
A 16 M SVOC R/L 11	16	-	150	-	8,5	17	VC.. 1103..

Ersatzteile / Spare parts / Комплекующие

Für Bohrstange For boring bar Для державки	Unterlage Support pad Опорная пластина	Büchse Bush Винт опорной пластины	Schraube Screw Винт крепления	Schlüssel Key Ключ	Sortiment Spare part set Набор комплектующих
..SVOC R/L 07	-	-	SS 5140	KS 1886	-
..SVOC R/L 11	-	-	SS 1751	KS 1751	S1751

Sortiment besteht aus: 3 Schrauben, 1 Schlüssel
 Complete set consists of: 3 Torx-screws, 1 Torx-screwdriver
 Набор комплектующих: Винт крепления - 3 штуки, Ключ - 1 штука.





Klemmhalter mit Schraubenklemmung
Toolholder with screw clamping
Державки с закреплением винтом

1

S-SV95C R/L

Anstellwinkel / Approach angle / Угол в плане: 95°

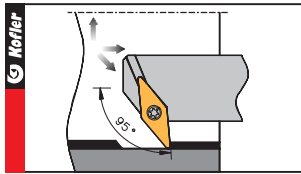

Stahlschaft
 Steel shank
 Стальная державка

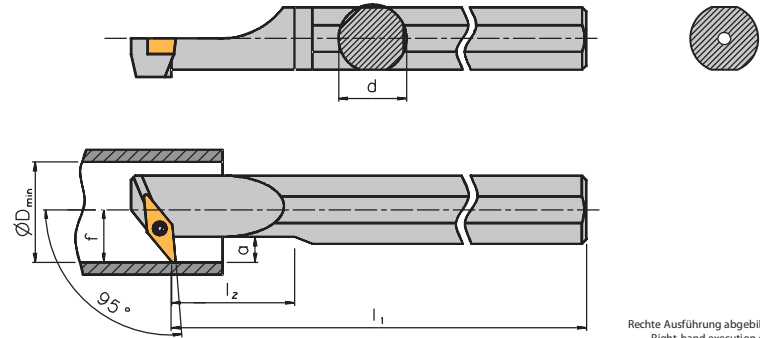

Rechte Ausführung abgebildet
 Right-hand execution shown
 Показано правостороннее исполнение

Bohrstangen / Boring bar / Державки

Bezeichnung Designation Обозначение	d	a	l ₁	l ₂	f	D _{min}	Wendeschneidplatte Indexable insert Пластины
S 10 H SV95C R/L 07	10	5	100	22	7	12,5	VC.. 0702..
S 12 K SV95C R/L 07	12	6	125	28	9	15,5	VC.. 0702..
S 16 M SV95C R/L 07	16	5	150	36	11	17,5	VC.. 0702..

A-SV95C R/L

Stahlschaft mit innerer Kühlmittelzufuhr
 Steel shank with through tool coolant
 Стальная державка с отверстием для подвода СОЖ

Bohrstangen / Boring bar / Державки

Bezeichnung Designation Обозначение	d	a	l ₁	l ₂	f	D _{min}	Wendeschneidplatte Indexable insert Пластины
A 10 H SV95C R/L 07	10	5	100	22	7	12,5	VC.. 0702..
A 12 K SV95C R/L 07	12	6	125	28	9	15,5	VC.. 0702..
A 16 M SV95C R/L 07	16	5	150	36	11	17,5	VC.. 0702..

E-SV95C R/L

Vollhartmetallschaft mit innerer Kühlmittelzufuhr
 Solid carbide shank with through tool coolant
 Стальная державка с отверстием для подвода СОЖ

Bohrstangen / Boring bar / Державки

Bezeichnung Designation Обозначение	d	a	l ₁	l ₂	f	D _{min}	Wendeschneidplatte Indexable insert Пластины
E 10 H SV95C R/L 07	10	5	100	32	7	12,5	VC.. 0702..
E 12 K SV95C R/L 07	12	6	125	40	9	15,5	VC.. 0702..
E 16 M SV95C R/L 07	16	5	150	55	11	17,5	VC.. 0702..

Ersatzteile / Spare parts / Комплекующие

Für Bohrstange For boring bar Для державки	Schraube Screw Винт крепления	Schlüssel Key Ключ
...SV95C R/L 07	SS 5140	KS 1886



Klemmhalter mit Schraubenklammerung
Toolholder with screw clamping
Державки с закреплением винтом

S-SVVC R/L

Anstellwinkel / Approach angle / Угол в плане: **72,5°**

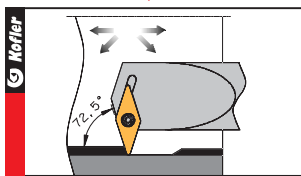

Stahlschaft
 Steel shank
 Стальная державка

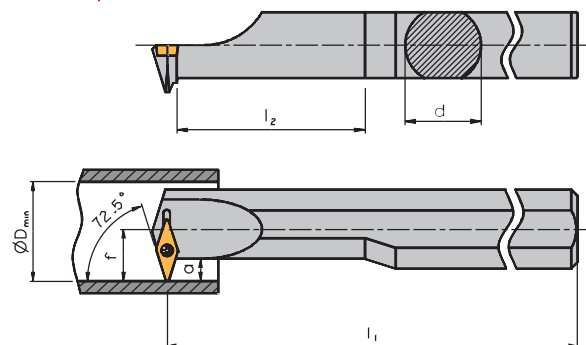

Rechte Ausführung abgebildet
 Right-hand execution shown
 Показано правостороннее исполнение

Bohrstangen / Boring bar / Державки

Bezeichnung Designation Обозначение	d	a	l ₁	l ₂	f	D _{min}	Wendeschneidplatte Indexable insert Пластины
S 10 H SVVC R/L 07	10	6	100	22	8	13,5	VC.. 0702..
S 12 K SVVC R/L 07	12	6	125	28	9	15,5	VC.. 0702..
S 16 M SVVC R/L 07	16	5	150	36	11	17,5	VC.. 0702..

A-SVVC R/L

Stahlschaft mit innerer Kühlmittelzufuhr
 Steel shank with through tool coolant
 Стальная державка с отверстием для подвода СОЖ

Bohrstangen / Boring bar / Державка

Bezeichnung Designation Обозначение	d	a	l ₁	l ₂	f	D _{min}	Wendeschneidplatte Indexable insert Пластины
A 10 H SVVC R/L 07	10	6	100	22	8	13,5	VC.. 0702..
A 12 K SVVC R/L 07	12	6	125	28	9	15,5	VC.. 0702..
A 16 M SVVC R/L 07	16	5	150	36	11	17,5	VC.. 0702..

E-SVVC R/L

Vollhartmetallschaft mit innerer Kühlmittelzufuhr
 Solid carbide shank with through tool coolant
 Стальная державка с отверстием для подвода СОЖ

Bohrstangen / Boring bar / Державки

Bezeichnung Designation Обозначение	d	a	l ₁	l ₂	f	D _{min}	Wendeschneidplatte Indexable insert Пластины
E 10 H SVVC R/L 07	10	6	100	32	8	13,5	VC.. 0702..
E 12 K SVVC R/L 07	12	6	125	40	9	15,5	VC.. 0702..
E 16 M SVVC R/L 07	16	5	150	55	11	17,5	VC.. 0702..

Ersatzteile / Spare parts / Комплекующие

Für Bohrstange For boring bar Для державки	Schraube Screw Винт крепления	Schlüssel Key Ключ
...SVVC R/L 07	SS 5140	KS 1886

Achtung: Rechter Halter → Linke Wendeschneidplatte, Linker Halter → Rechte Wendeschneidplatte
 Attention: Holder right hand design → Left-hand indexable insert, Holder left hand design → Right-hand indexable insert
 Внимание: Правосторонняя державка → левосторонняя пластина Левосторонняя державка → правосторонняя пластина





Klemmhalter mit Schraubenklemmung
Toolholder with screw clamping
Державки с закреплением винтом

1

S-SVXC R/L

Anstellwinkel / Approach angle / Угол в плане: 113°

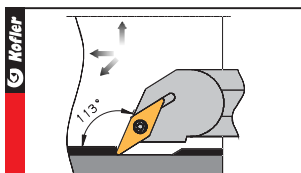

Stahlschaft
 Steel shank
 Стальная державка

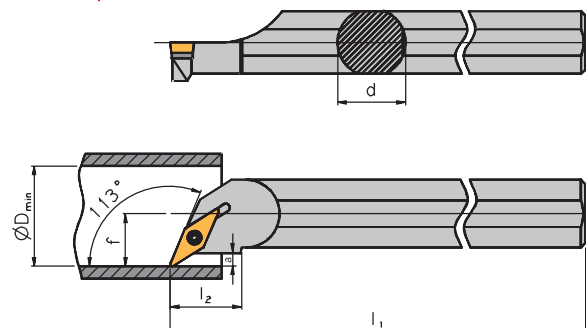

Rechte Ausführung abgebildet
 Right-hand execution shown
 Показано правостороннее исполнение

Bohrstangen / Boring bar / Державки

Bezeichnung Designation Оозначение	d	a	l ₁	l ₂	f	D _{min}	Wendeschnidplatte Indexable insert Пластины
S 10 H SVXC R/L 07	10	3	100	22	7	12,5	VC.. 0702..
S 12 K SVXC R/L 07	12	3	125	28	9	15,5	VC.. 0702..
S 16 M SVXC R/L 07	16	3	150	36	11	19,5	VC.. 0702..

A-SVXC R/L

Stahlschaft mit innerer Kühlmittelzufuhr
 Steel shank with through tool coolant
 Стальная державка с отверстием для подвода СОЖ

Bohrstangen / Boring bar / Державки

Bezeichnung Designation Обозначение	d	a	l ₁	l ₂	f	D _{min}	Wendeschnidplatte Indexable insert Пластины
A 10 H SVXC R/L 07	10	3	100	22	7	12,5	VC.. 0702..
A 12 K SVXC R/L 07	12	3	125	28	9	15,5	VC.. 0702..
A 16 M SVXC R/L 07	16	3	150	36	11	19,5	VC.. 0702..

E-SVXC R/L

Vollhartmetallschaft mit innerer Kühlmittelzufuhr
 Solid carbide shank with through tool coolant
 Стальная державка с отверстием для подвода СОЖ

Bohrstangen / Boring bar / Державки

Bezeichnung Designation Обозначение	d	a	l ₁	l ₂	f	D _{min}	Wendeschnidplatte Indexable insert Пластины
E 10 H SVXC R/L 07	10	3	100	32	7	12,5	VC.. 0702..
E 12 K SVXC R/L 07	12	3	125	40	9	15,5	VC.. 0702..
E 16 M SVXC R/L 07	16	3	150	55	11	19,5	VC.. 0702..

Ersatzteile / Spare parts / Комплекующие

Für Bohrstange For boring bar Для державки	Schraube Screw Винт крепления	Schlüssel Key Ключ
...SVXC R/L 07	SS 5140	KS 1886

Achtung: Rechter Halter → Linke Wendschneidplatte, Linker Halter → Rechte Wendschneidplatte
 Attention: Holder right hand design → Left-hand indexable insert, Holder left hand design → Right-hand indexable insert
 Внимание: Правосторонняя державка → левосторонняя пластина, Левосторонняя державка → правосторонняя пластина



Klemmhalter mit Schraubenklemmung Toolholder with screw clamping Державки с закреплением винтом

A-SWFC R/L

Anstellwinkel / Approach angle /
Угол в плане: 90°

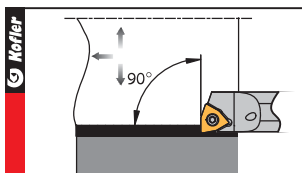

Stahlschaft mit innerer Kühlmittelzufuhr
Steel shank with through tool coolant
Стальная державка с отверстием для подвода СОЖ

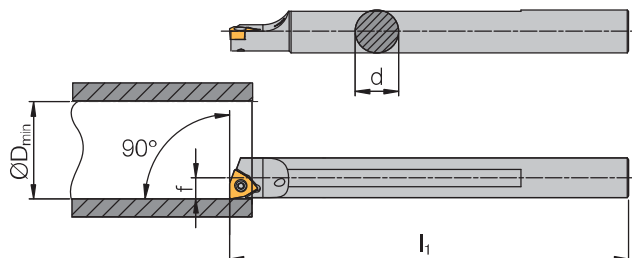

A, E



Bohrstangen / Boring bar / Державки

Rechte Ausführung abgebildet
Right-hand execution shown
Показано правостороннее исполнение

Bezeichnung Designation Обозначение	d	l ₁	f	D _{min}	Wendeschneidplatte Indexable insert Пластины
A 08 F SWFC R/L 04-A	8	80	4,3	8,5	WC.. 0402..
A 10 H SWFC R/L 04-A	10	100	5,3	10,4	WC.. 0402..
A 12 K SWFC R/L 04-A	12	125	6,3	12,5	WC.. 0402..
A 16 M SWFC R/L 06-A	16	150	8,8	16,5	WC.. 06T3..

Hinweis: A-Ausführung im hinteren Schaftbereich zylindrisch

/ Remark: A-execution with cylindrical part at the end of the shank

Примечание: Исполнение «А» имеет цилиндрическую форму на всей длине державки.

E-SWFC R/L

Vollhartmetallschaft mit innerer Kühlmittelzufuhr
Solid carbide shank with through tool coolant
Стальная державка с отверстием для подвода СОЖ

Bohrstangen / Boring bar / Державки

Bezeichnung Designation Обозначение	d	l ₁	f	D _{min}	Wendeschneidplatte Indexable insert Пластины
E 08 H SWFC R/L 04-A	8	100	4,3	8,5	WC.. 0402..
E 10 K SWFC R/L 04-A	10	125	5,3	10,4	WC.. 0402..
E 12 Q SWFC R/L 04-A	12	180	6,3	12,5	WC.. 0402..
E 16 R SWFC R/L 06-A	16	200	8,8	16,5	WC.. 06T3..

Ersatzteile / Spare parts / Комплекующие

Für Bohrstange For boring bar Для державки	Unterlage Support pad Опорная пластина	Büchse Bush Винт опорной пластины	Schraube Screw Винт крепления	Schlüssel Key Ключ	Sortiment Spare part set Набор комплектующих
.08 - 12. SWFC R/L 04-A	-	-	SS 1751	KS 1751	S 1751
.16 SWFC R/L 06-A	-	-	SS 1111	KS 1111	S 1111

Sortiment besteht aus: 3 Schrauben, 1 Schlüssel
Complete set consists of: 3 Torx-screws, 1 Torx-screwdriver
Набор комплектующих: Винт крепления - 3 штуки, Ключ - 1 штука.



Klemmhalter mit Schraubenklemmung Toolholder with screw clamping Державки с закреплением винтом

S-SWLC R/L

Anstellwinkel / Approach angle /
Угол в плане: 95°

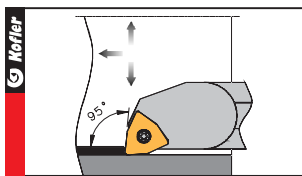

Stahlschaft
Steel shank
Стальная державка

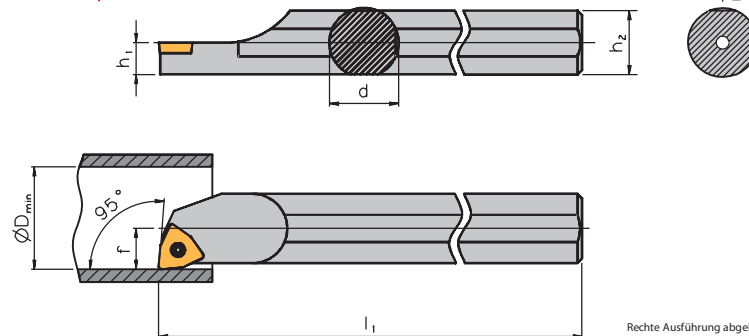

Rechte Ausführung abgebildet
Right-hand execution shown
Показано правостороннее исполнение

Bohrstangen / Boring bar / Державки

Bezeichnung Designation Обозначение	d	h ₁	h ₂	l ₁	l ₂	f	D _{min}	Wendeschneidplatte Indexable insert Пластины
S 08 H SWLC R/L 04	8	3,5	7	100	-	5	11,0	WC.. 0402..
S 10 K SWLC R/L 04	10	4,5	9	125	-	7	14,0	WC.. 0402..
S 12 Q SWLC R/L 04	12	5,5	11	180	-	9	17,0	WC.. 0402..
S 16 R SWLC R/L 06	16	7,5	15	200	-	11	21,0	WC.. 06T3..

A-SWLC R/L

Stahlschaft mit innerer Kühlmittelzufuhr
Steel shank with through tool coolant
Стальная державка с отверстием для подвода СОЖ

Bohrstangen / Boring bar / Державки

Bezeichnung Designation Обозначение	d	h ₁	h ₂	l ₁	l ₂	f	D _{min}	Wendeschneidplatte Indexable insert Пластины
A 08 F SWLC R/L 04	8	4,0	7,5	80	-	5	11,0	WC.. 0402..
A 10 H SWLC R/L 04	10	5,0	9,5	100	-	7	14,0	WC.. 0402..
A 12 K SWLC R/L 04	12	6,0	11,5	125	-	9	17,0	WC.. 0402..
A 16 M SWLC R/L 06	16	8,0	15,5	150	-	11	21,0	WC.. 06T3..

Hinweis: A-Ausführung im hinteren Schaftbereich zylindrisch / Remark: A-execution with cylindrical part at the end of the shank / Примечание: Исполнение «А» имеет цилиндрическую форму на всей длине державки.

E-SWLC R/L

Vollhartmetallschaft mit innerer Kühlmittelzufuhr
Solid carbide shank with through tool coolant
Стальная державка с отверстием для подвода СОЖ

Bohrstangen / Boring bar / Державки

Bezeichnung Designation Обозначение	d	h ₁	h ₂	l ₁	l ₂	f	D _{min}	Wendeschneidplatte Indexable insert Пластины
E 08 H SWLC R/L 04	8	4,0	7,5	100	-	5	11,0	WC.. 0402..
E 10 K SWLC R/L 04	10	5,0	9,5	125	-	7	14,0	WC.. 0402..
E 12 Q SWLC R/L 04	12	6,0	11,5	180	-	9	17,0	WC.. 0402..
E 16 R SWLC R/L 06	16	8,0	15,5	200	-	11	21,0	WC.. 06T3..

Ersatzteile / Spare parts / Комплекующие

Für Bohrstange For boring bar Для державки	Unterlage Support pad Опорная пластина	Büchse Bush Винт опорной пластины	Schraube Screw Винт крепления	Schlüssel Key Ключ	Sortiment ④ Spare part set Набор комплектующих
.08 - 12. SWLC R/L 04	-	-	SS 1751	KS 1751	S 1751
.16 SWLC R/L 06	-1	-	SS 1111	KS 1111	S 1111

④ Sortiment besteht aus: 3 Schrauben, 1 Schlüssel
Complete set consists of: 3 Torx-screws, 1 Torx-screwdriver
Набор комплектующих: Винт крепления - 3 штуки, Ключ - 1 штука.

Achtung: Rechter Halter → Linke Wendeschneidplatte,
Attention: Holder right hand design → Left-hand indexable insert,
Внимание: Правосторонняя державка → левосторонняя пластина

Linker Halter → Rechte Wendeschneidplatte
Holder left hand design → Right-hand indexable insert
Левосторонняя державка → правосторонняя пластина



Klemmhalter mit Schraubenklemmung
Toolholder with screw clamping
Державки с закреплением винтом

E-SWUC R/L

Anstellwinkel / Approach angle /
 Угол в плане: 93°

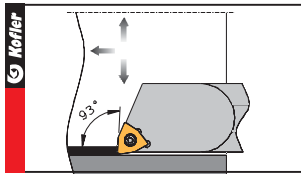

Vollhartmetallschaft mit innerer Kühlmittelzufuhr
 Solid carbide shank with through tool coolant
 Стальная державка с отверстием для подвода СОЖ

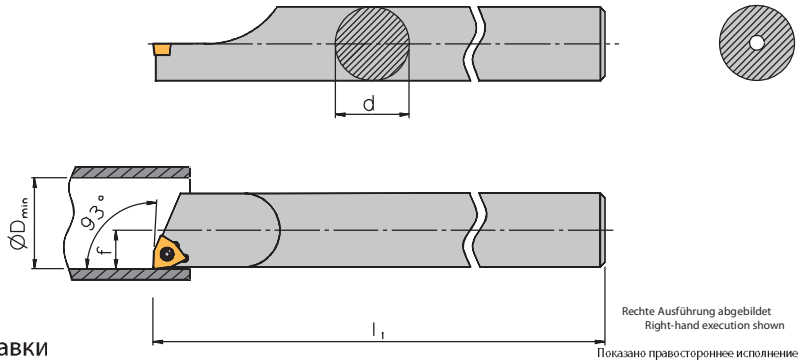

Bohrstange / Boring bar / Державки

Bezeichnung Designation Обозначение	d	D	l ₁	l ₂	f	D _{min}	Wendeschneidplatte Indexable insert Пластины
E 05 F SWUC R/L 02	5	-	85	-	2,9	5,8	WC.. 0201..
E 06 G SWUC R/L 02	6	-	95	-	3,9	7,8	WC.. 0201..

Ersatzteile / Spare parts / Комплекующие

Für Bohrstange For boring bar Для державки	Schraube Screw Винт крепления	Schlüssel Key Ключ
...SWUC R/L 02	T 2.03	KS 1886

Achtung: Rechter Halter
 Attention: Holder right hand design
 Внимание: Правосторонняя державка

→ Linke Wendeschneidplatte,
 → Left-hand indexable insert,
 → левосторонняя пластина

Linker Halter
 Holder left hand design
 Левосторонняя державка

→ Rechte Wendeschneidplatte
 → Right-hand indexable insert
 → правосторонняя пластина





Klemmhalter mit Schraubenklemmung
Toolholder with screw clamping
Державки с закреплением винтом

1

S-SWUC R/L

Anstellwinkel / Approach angle /
 Угол в плане: 93°

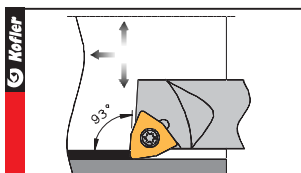

Abgesetzter Stahlschaft
 Recessed steel shank
 Стальная державка

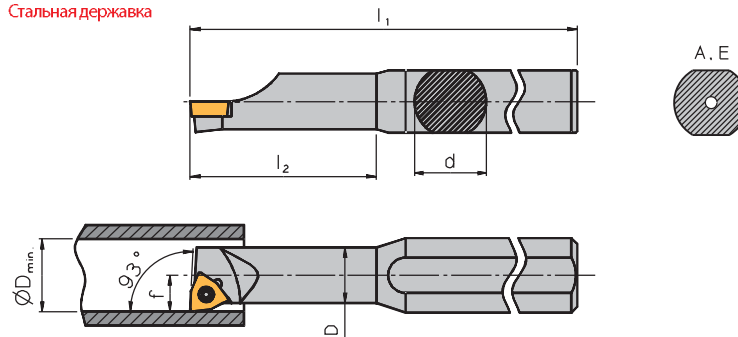

Rechte Ausführung abgebildet
 Right-hand execution shown
 Показано правостороннее исполнение

Bohrstangen / Boring bar / Державки

Bezeichnung Designation Обозначение	d	D	l ₁	l ₂	f	D _{min}	Wendeschneidplatte Indexable insert Пластины
S 0508 H SWUC R/L 02	8	5	100	18	2,9	5,8	WC.. 0201..
S 0608 H SWUC R/L 02	8	6	100	24	3,9	7,8	WC.. 0201..

A-SWUC R/L

Abgesetzter Stahlschaft mit innerer Kühlmittelzufuhr
 Recessed steel shank with through tool coolant
 Стальная державка с отверстием для подвода СОЖ

Bohrstangen / Boring bar / Державка

Bezeichnung Designation Обозначение	d	D	l ₁	l ₂	f	D _{min}	Wendeschneidplatte Indexable insert Пластины
A 0508 H SWUC R/L 02	8	5	100	18	2,9	5,8	WC.. 0201..
A 0608 H SWUC R/L 02	8	6	100	24	3,9	7,8	WC.. 0201..

E-SWUC R/L

Abgesetzter Vollhartmetallschaft mit innerer Kühlmittelzufuhr
 Recessed solid carbide shank with through tool coolant
 Стальная державка с отверстием для подвода СОЖ

Bohrstangen / Boring bar / Державки

Bezeichnung Designation Обозначение	d	D	l ₁	l ₂	f	D _{min}	Wendeschneidplatte Indexable insert Пластины
E 0508 H SWUC R/L 02	8	5	100	24	2,9	5,8	WC.. 0201..
E 0608 H SWUC R/L 02	8	6	100	32	3,9	7,8	WC.. 0201..

Ersatzteile / Spare parts / Комплекующие

Für Bohrstange For boring bar Для державки	Schraube Screw Винт крепления	Schlüssel Key Ключ
...SWUC R/L 02	T 2.03	KS 1886

Achtung: Rechter Halter → Linke Wendeschneidplatte,
 Attention: Holder right hand design → Left-hand indexable insert,
 Внимание: Правосторонняя державка → левосторонняя пластина

Linker Halter → Rechte Wendeschneidplatte,
 Holder left hand design → Right-hand indexable insert
 Левосторонняя державка → правосторонняя пластина

Wendeschnidplatten
Indexable inserts
Сменные пластины

1

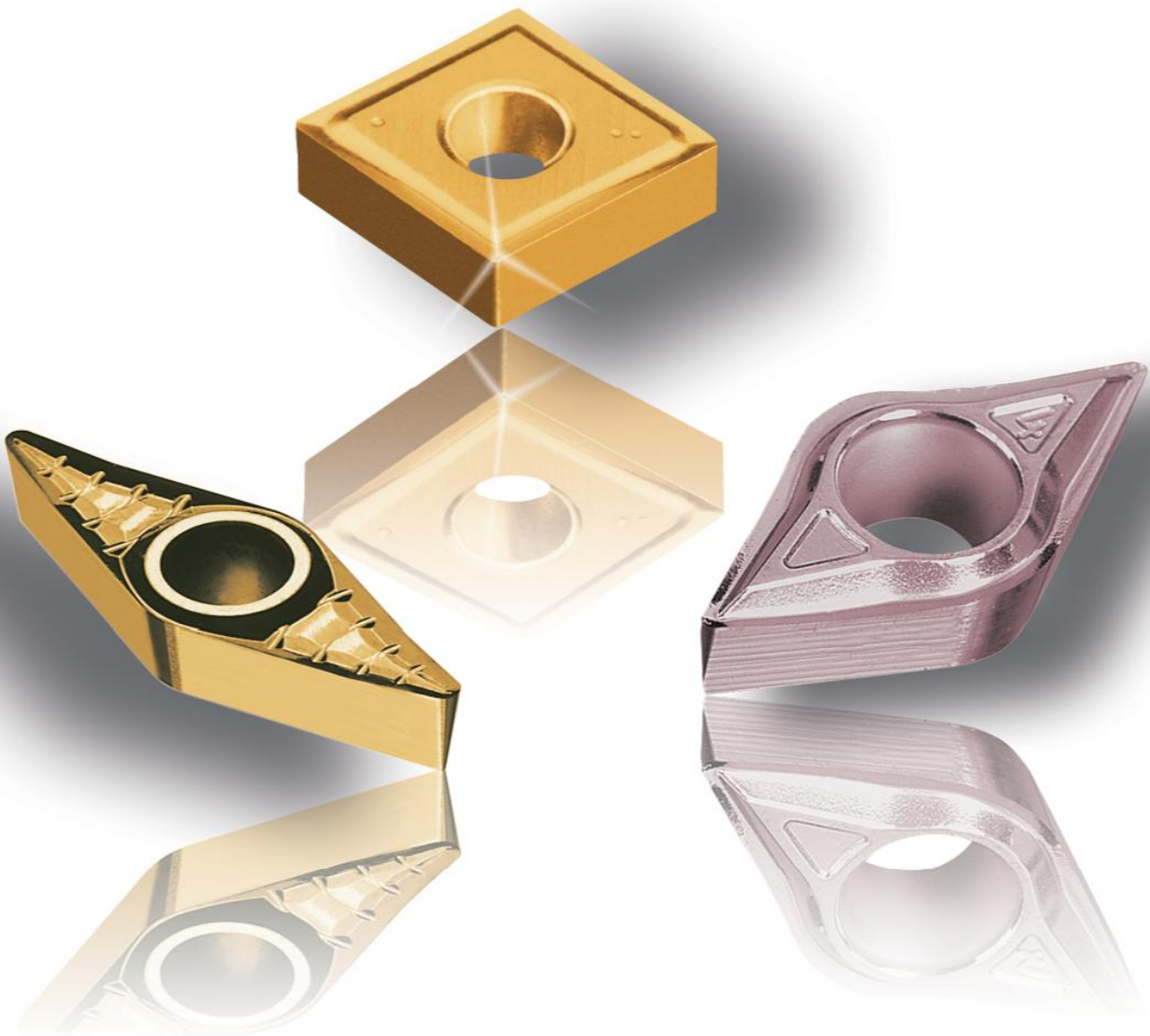



ISO-Bezeichnungssystem für Wendeschneidplatten
 ISO designation system for indexable inserts
 Система обозначения сменных пластин по ISO

1

	<p>3° A 5° B 7° C 15° D 20° E 25° F 30° G 0° N 11° P ↔ O</p> <p>Sonstige Others Другие</p>	<table border="1"> <thead> <tr> <th colspan="3">Grenzabmaße (mm) Range of tolerance Campo tolleranza</th> <th colspan="2">Toleranzklasse Tolerance Classe tolleranza</th> </tr> <tr> <th>d ±</th> <th>m ±</th> <th>s ±</th> <th colspan="2"></th> </tr> </thead> <tbody> <tr> <td>0,025</td> <td>0,005</td> <td>0,025</td> <td colspan="2">A</td> </tr> <tr> <td>0,025</td> <td>0,013</td> <td>0,025</td> <td colspan="2">C</td> </tr> <tr> <td>0,025</td> <td>0,025</td> <td>0,025</td> <td colspan="2">E</td> </tr> <tr> <td>0,013</td> <td>0,005</td> <td>0,025</td> <td colspan="2">F</td> </tr> <tr> <td>0,025</td> <td>0,025</td> <td>0,05-0,13</td> <td colspan="2">G</td> </tr> <tr> <td>0,013</td> <td>0,013</td> <td>0,025</td> <td colspan="2">H</td> </tr> <tr> <td>0,05-0,15</td> <td>0,005</td> <td>0,025</td> <td colspan="2">J</td> </tr> <tr> <td>0,05-0,15</td> <td>0,013</td> <td>0,025</td> <td colspan="2">K</td> </tr> <tr> <td>0,05-0,15</td> <td>0,025</td> <td>0,025</td> <td colspan="2">L</td> </tr> <tr> <td>0,05-0,15</td> <td>0,08-0,2</td> <td>0,05-0,13</td> <td colspan="2">M</td> </tr> <tr> <td>0,05-0,15</td> <td>0,08-0,2</td> <td>0,025</td> <td colspan="2">N</td> </tr> <tr> <td>0,08-0,25</td> <td>0,13-0,38</td> <td>0,13</td> <td colspan="2">U</td> </tr> <tr> <td colspan="3">Sonderausführung Special shape Другое значение</td> <td>↔</td> <td>X</td> </tr> </tbody> </table>	Grenzabmaße (mm) Range of tolerance Campo tolleranza			Toleranzklasse Tolerance Classe tolleranza		d ±	m ±	s ±			0,025	0,005	0,025	A		0,025	0,013	0,025	C		0,025	0,025	0,025	E		0,013	0,005	0,025	F		0,025	0,025	0,05-0,13	G		0,013	0,013	0,025	H		0,05-0,15	0,005	0,025	J		0,05-0,15	0,013	0,025	K		0,05-0,15	0,025	0,025	L		0,05-0,15	0,08-0,2	0,05-0,13	M		0,05-0,15	0,08-0,2	0,025	N		0,08-0,25	0,13-0,38	0,13	U		Sonderausführung Special shape Другое значение			↔	X	<p>Sonderausführung Special shape Специальная конструкция</p> <p>↔ X</p>
Grenzabmaße (mm) Range of tolerance Campo tolleranza			Toleranzklasse Tolerance Classe tolleranza																																																																											
d ±	m ±	s ±																																																																												
0,025	0,005	0,025	A																																																																											
0,025	0,013	0,025	C																																																																											
0,025	0,025	0,025	E																																																																											
0,013	0,005	0,025	F																																																																											
0,025	0,025	0,05-0,13	G																																																																											
0,013	0,013	0,025	H																																																																											
0,05-0,15	0,005	0,025	J																																																																											
0,05-0,15	0,013	0,025	K																																																																											
0,05-0,15	0,025	0,025	L																																																																											
0,05-0,15	0,08-0,2	0,05-0,13	M																																																																											
0,05-0,15	0,08-0,2	0,025	N																																																																											
0,08-0,25	0,13-0,38	0,13	U																																																																											
Sonderausführung Special shape Другое значение			↔	X																																																																										
<p>C</p>	<p>N</p>	<p>M</p>	<p>G</p>																																																																											
<p>Plattenform Shape Форма пластины</p>	<p>Freiwinkel Clearance angle Задний угол</p>	<p>Toleranzen Tolerances Tolleranza Допуски</p>	<p>Plattentyp Type of inserts Тип пластины</p>																																																																											



ISO-Bezeichnungssystem für Wendeschneidplatten
 ISO designation system for indexable inserts
 Система обозначения сменных пластин по ISO

1

C D R S T V W 	 		 r [mm] 0,2 02 0,4 04 0,8 08 1,2 12 1,6 16 2,4 24 0 00	F Scharf Sharp Острая кромка E Gerundet Rounded Округлённая режущая кромка T Gefast Chamfered Кромка с отрицательной фаской S Gefast und gerundet Chamfered and rounded Округлённая кромка с отрицательной фаской	 R L N	Für besondere Formen der Spanleitstufen kann an der 10. Stelle ein firmeninterner Code angeführt werden (z.B. - NMG - NA - ACB). Special chipgroove shapes can be indicated by an internal company coding system at the 10th position (for example: - NMG - NA - ACB). Специальное обозначение изготовителя (например: - NMG - NA - ACB).																																																																																																							
	s [mm] 1,59 01 1,98 T1 2,38 02 3,18 03 3,97 T3 4,76 04 5,56 05 6,35 06 7,94 07 9,52 09	Kennzahl / Index / Обозначение																																																																																																											
(Formen пластины) <table border="1"> <thead> <tr> <th>d (mm)</th> <th>C</th> <th>D</th> <th>R</th> <th>S</th> <th>T</th> <th>V</th> <th>W</th> </tr> </thead> <tbody> <tr> <td>3,97 (5,6)</td> <td></td> <td></td> <td></td> <td></td> <td>06 (6,35)</td> <td>07 (6,92)</td> <td>02 (2,70)</td> </tr> <tr> <td>5,56 (5,6)</td> <td>05 (5,6)</td> <td></td> <td></td> <td></td> <td>09 (9,6)</td> <td></td> <td>03 (3,8)</td> </tr> <tr> <td>6,0</td> <td></td> <td></td> <td>06</td> <td></td> <td></td> <td></td> <td></td> </tr> <tr> <td>6,35 (6,45)</td> <td>06 (6,45)</td> <td>07 (7,75)</td> <td></td> <td></td> <td>11 (11,0)</td> <td>11 (11,1)</td> <td>04 (4,3)</td> </tr> <tr> <td>7,94</td> <td></td> <td></td> <td></td> <td></td> <td></td> <td>13 (13,1)</td> <td></td> </tr> <tr> <td>8,0</td> <td></td> <td></td> <td>08</td> <td></td> <td></td> <td></td> <td></td> </tr> <tr> <td>9,525 (9,67)</td> <td>09 (9,67)</td> <td>11 (11,6)</td> <td></td> <td>09 (9,525)</td> <td>16 (16,5)</td> <td>16 (16,5)</td> <td>06 (6,5)</td> </tr> <tr> <td>10,0</td> <td></td> <td></td> <td>10</td> <td></td> <td></td> <td></td> <td></td> </tr> <tr> <td>12,0</td> <td></td> <td></td> <td>12</td> <td></td> <td></td> <td></td> <td></td> </tr> <tr> <td>12,70 (12,9)</td> <td>12 (12,9)</td> <td>15 (15,5)</td> <td></td> <td>12 (12,7)</td> <td>22 (22,0)</td> <td>22 (22,1)</td> <td>08 (8,72)</td> </tr> <tr> <td>15,875</td> <td>16 (16,1)</td> <td></td> <td></td> <td>15 (15,875)</td> <td></td> <td></td> <td></td> </tr> <tr> <td>19,05</td> <td>19 (19,3)</td> <td></td> <td></td> <td>19 (19,05)</td> <td></td> <td></td> <td></td> </tr> </tbody> </table>						d (mm)	C	D	R	S	T	V	W	3,97 (5,6)					06 (6,35)	07 (6,92)	02 (2,70)	5,56 (5,6)	05 (5,6)				09 (9,6)		03 (3,8)	6,0			06					6,35 (6,45)	06 (6,45)	07 (7,75)			11 (11,0)	11 (11,1)	04 (4,3)	7,94						13 (13,1)		8,0			08					9,525 (9,67)	09 (9,67)	11 (11,6)		09 (9,525)	16 (16,5)	16 (16,5)	06 (6,5)	10,0			10					12,0			12					12,70 (12,9)	12 (12,9)	15 (15,5)		12 (12,7)	22 (22,0)	22 (22,1)	08 (8,72)	15,875	16 (16,1)			15 (15,875)				19,05	19 (19,3)			19 (19,05)			
d (mm)	C	D	R	S	T	V	W																																																																																																						
3,97 (5,6)					06 (6,35)	07 (6,92)	02 (2,70)																																																																																																						
5,56 (5,6)	05 (5,6)				09 (9,6)		03 (3,8)																																																																																																						
6,0			06																																																																																																										
6,35 (6,45)	06 (6,45)	07 (7,75)			11 (11,0)	11 (11,1)	04 (4,3)																																																																																																						
7,94						13 (13,1)																																																																																																							
8,0			08																																																																																																										
9,525 (9,67)	09 (9,67)	11 (11,6)		09 (9,525)	16 (16,5)	16 (16,5)	06 (6,5)																																																																																																						
10,0			10																																																																																																										
12,0			12																																																																																																										
12,70 (12,9)	12 (12,9)	15 (15,5)		12 (12,7)	22 (22,0)	22 (22,1)	08 (8,72)																																																																																																						
15,875	16 (16,1)			15 (15,875)																																																																																																									
19,05	19 (19,3)			19 (19,05)																																																																																																									
<h1>16 06 08 E N NMG</h1>																																																																																																													
Schneidlänge Edge length Длина режущей кромки		Plattendicke Insert thickness Толщина пластины		Eckenradius Corner radius Радиус при вершине																																																																																																									
				Schneidkante Edge condition Состояние режущей кромки																																																																																																									
				Schneidrichtung Cutting direction Исполнение																																																																																																									
				Zusatzangabe Additional coding system Обозначение изготовителя																																																																																																									



Spanformgeometrien
Chipgroove geometries
Геометрия стружколомов



1

Bearbeitung Stahl - positiv
Steel Machining - positive
-

- AB

Geometrie für die Feinschlicht- und Schlichtbearbeitung zum Erreichen hoher Oberflächengüten und Toleranzgenauigkeiten bei der Zerspaltung von Stahl. Mini - Spanbrecher für kontrollierten Spanbruch. Scharfe Schneidkante.



- AB

Geometry for fine finishing and finishing of steel. Mini - chip breaker for controlled chip breaking. Sharp cutting edge.

Schlitzzerspanung
Finishing
Чистовая обработка

einseitig
single sided
односторонняя



- AB

Геометрия для чистовой обработки сталей и нержавеющей сталей. Мини-стружколом для контроля процесса стружкообразования. Острая режущая кромка.

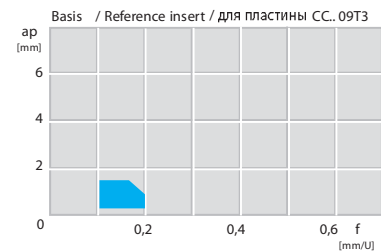

- PS1

Geometrie zum Schlachten von Stahl, Stahlguss und rostfreien Stählen.



- PS1

Geometry for finishing steel, cast steel and stainless steel.

Schlitzzerspanung
Finishing
Чистовая обработка

einseitig
single sided
односторонняя



- PS1

Геометрия для чистовой обработки сталей, стального литья и нержавеющей сталей.

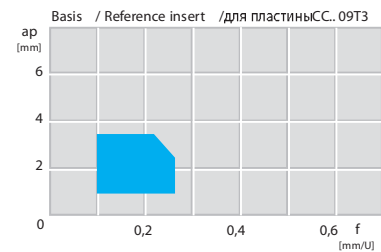

- WMS

WIPER - Geometrie für die Stahlbearbeitung. Extrem hochwertige Oberflächen durch Breitschlitzgeometrie. Optimaler Spanbruch durch erhöhten Vorschub, dadurch geringere Bearbeitungszeiten und höhere Wirtschaftlichkeit.



- WMS

Wiper geometry for machining steel. Extremely good surface finish due to wiper technology. Optimum chip breaking due to increased feed rates leading to reduced machine time and increased efficiency.

Schlitz und mittlere Zerspaltung
Finishing and medium cutting
Чистовая и получистовая обработка

einseitig
single sided
Односторонняя



- WMS

Геометрия Wiper для обработки сталей. Чрезвычайно высокое качество обработанной поверхности в следствии применения технологии Wiper. Оптимизация процесса стружкообразования при увеличенных подачах, а также снижение машинного времени и повышение эффективности процесса.

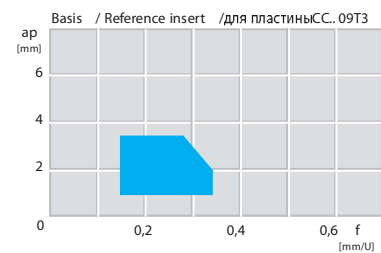



Spanformgeometrien
Chipgroove geometries
Геометрии стружколомов



Bearbeitung Stahl - positiv
Steel Machining - positive

1

- PMS
Geometrie zum Schlichten bis mittlere Zerspanung von Stahl.

- PMS
Geometry for finishing to medium machining of steel.

- PMS
Геометрия для чистовой и получистовой обработки сталей.



Schlicht und mittlere Zerspanung
Finishing and medium cutting
Чистовая и получистовая обработка

einseitig
single sided
односторонняя

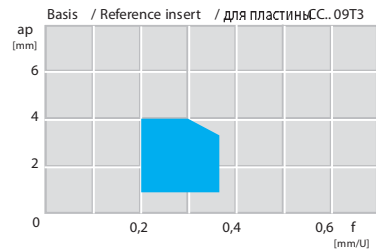

- AM
Spanformgeometrie für den mittleren Zerspanungsbereich von Stahl, rostfreiem (austenischem) Stahl und auch Gusswerkstoffen. Sehr gute Spankontrolle bei geringen bis mittleren Spantiefen und Vorschubbereichen durch die Anordnung der speziell konzipierten Spanformknoppen. Weicher Spanablauf und niedrige Schnittkräfte

- AM
Chip breaker geometry for medium machining of steel, austenitic stainless steel and cast materials. Due to special chip pimples, very good chip control at low to medium depth of cut and feed rates. Smooth chip evacuation and low cutting forces.

- AM
Геометрия стружколома для получистовой обработки сталей, аустенитных нержавеющей сталей и стального литья. Благодаря специальному рельефу стружколома, очень хороший контроль процесса стружкообразования на малых и средних глубинах резания и подачах. Благоприятные условия отвода стружки и низкие силы резания.



Mittlere Zerspanung
Medium cutting
Получистовая обработка

einseitig
single sided
односторонняя

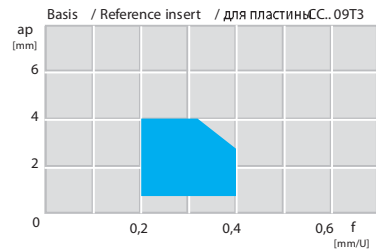

Für die Schlichtbearbeitung sind auch die hochpositiven Geometrien -AWI, -ASF, -ALU und -ACB in beschichteter Ausführung hervorragend geeignet.
For finish machining we also recommend our high positive geometries; -AWI, -ASF, -ALU and -ACB but in coated configuration.
Для чистовой обработки мы так же рекомендуем наши высокопозитивные геометрии -AWI, -ASF, -ALU и -ACB в исполнении с покрытием.

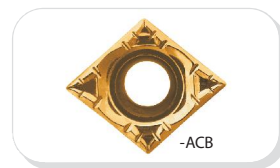



Spanformgeometrien
Chipgroove geometries
Геометрии стружколомов



1

Bearbeitung rostfreier Stahl - positiv
Stainless Steel Machining - positive
Обработка нержавеющей стали - ПОЗИТИВНЫЕ

- PS
Geometrie für die Feinschichtbearbeitung von rostfreiem Stahl und warmfesten Legierungen mit geringen Vorschüben und Spantiefen. Kontrollierter Spanbruch. Niedrige Schnittkräfte. Am Umfang geschliffene Wendeschneidplatte. Auch geeignet für die Bearbeitung von NE-Metallen



- PS
Geometry for finishing stainless steel and heat resistant alloys with low feed rates and depth of cut. Controlled chip breaking. Low cutting forces. Periphery ground insert also suitable for none ferrous materials.

Schlichtzerspanung
Finishing
Чистовая обработка

einseitig
single sided
односторонняя



- PS
Геометрия для чистовой обработки нержавеющей сталей и жаропрочных сплавов на малых подачах и глубинах резания. Контроль стружкообразования. Низкие силы резания. Так же может применяться для обработки материалов не содержащих железа.

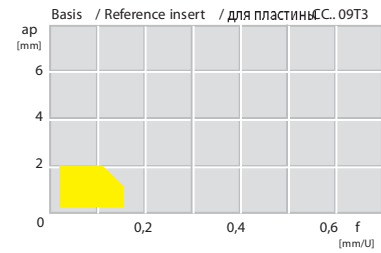

- AEC
Geometrie zum Schlichten von Stahl und rostfreiem Stahl. In unbeschichteter Ausführung auch geeignet für NE-Metalle.



- AEC
Precision sintered geometry for finishing steel and stainless steel. As uncoated version also suitable for none ferrous materials.

Schlichtzerspanung
Finishing
Чистовая обработка

einseitig
single sided
односторонняя



- AEC
Спечённая с высокой точностью пластина для чистовой обработки сталей и нержавеющей сталей. Данная пластина в исполнении без покрытия, так же применяется для обработки материалов не содержащих железа.

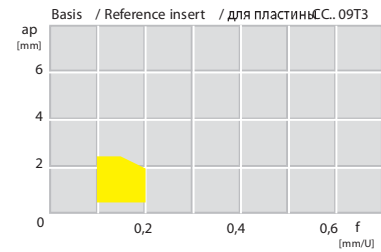

- PS1
Geometrie zum Schlichten von Stahl, Stahlguss und rostfreien Stählen.



- PS1
Geometry for finishing steel, cast steel and stainless steel.

Schlichtzerspanung
Finishing
Чистовая обработка

einseitig
single sided
односторонняя

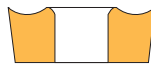

- PS1
Геометрия для чистовой обработки сталей, стального литья и нержавеющей сталей.

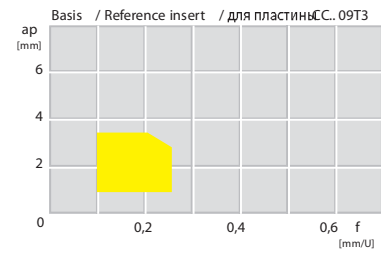



Spanformgeometrien
Chipgroove geometries
Геометрии стружколомов



Bearbeitung rostfreier Stahl - positiv
Stainless Steel Machining - positive
Обработка нержавеющей стали - ПОЗИТИВНЫЕ

1

- WMS

WIPER – Geometrie für die Bearbeitung rostfreier Stähle. Extrem hochwertige Oberflächen durch Breitschlichtgeometrie. Optimaler Spanbruch durch erhöhten Vorschub, dadurch geringere Bearbeitungszeiten und höhere Wirtschaftlichkeit.



- WMS

Wiper geometry for machining steel. Extremely good surface finish due to wiper technology. Optimum chip breaking due to increased feed rates leading to reduced machine time and increased efficiency.

Schlicht und mittlere Zerspangung
Finishing and medium cutting
Чистовая и получистовая обработка

einseitig
single sided
односторонняя



- WMS

Геометрия Wiper для обработки сталей. Очень высокое качество обработанной поверхности в следствии применения технологии Wiper. Оптимизация процесса стружкообразования на увеличенных подачах, а так же снижение машинного времени и повышение эффективности процесса.

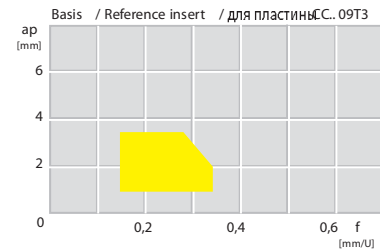

- AM

Spanformgeometrie für den mittleren Zerspangungsbereich von Stahl, rostfreiem (austenitischem) Stahl und auch Gusswerkstoffen. Sehr gute Spankontrolle bei geringen bis mittleren Spantiefen und Vorschub-bereichen durch die Anordnung der speziell konzipierten Spanformnoppen. Weicher Spanablauf und niedrige Schnittkräfte.



- AM

Chip breaker geometry for medium machining of steel, austenitic stainless steel and cast materials. Due to special chip pimples, very good chip control at low to medium depth of cut and feed rates. Smooth chip evacuation and low cutting forces.

Mittlere Zerspangung
Medium cutting
Получистовая обработка

einseitig
single sided
односторонняя



- AM

Геометрия стружколома для получистовой обработки сталей, аустенитных нержавеющей сталей и стального литья. Благодаря специальному рельефу стружколома, очень хороший контроль процесса стружкообразования на малых и средних глубинах резания и подачах. Благоприятные условия отвода стружки и низкие силы резания.

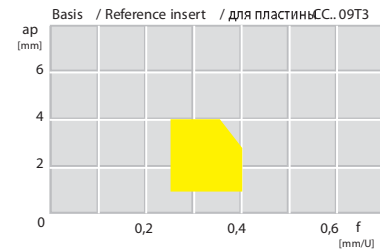

Für die Schlichtbearbeitung sind auch die hochpositiven Geometrien -AWI, -ASF, -ALU und -ACB in beschichteter Ausführung hervorragend geeignet.

For finish machining we also recommend our high positive geometries; -AWI, -ASF, -ALU and -ACB but in coated configuration.

Для чистовой обработки мы так же рекомендуем наши высокопозитивные геометрии -AWI, -ASF, -ALU и -ACB в исполнении с покрытием.

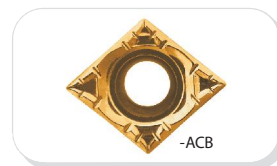



Spanformgeometrien
Chipgroove geometries
Геометрии стружколомов



1

Bearbeitung NE-Metalle - positiv
None ferrous materials - positive
-

- PS

Umfangsgeschliffene Geometrie in unbeschichteter Ausführung zum Schlichten von Nichteisenmetallen. Beschichtet geeignet für die Schlichtbearbeitung von rostfreiem Stahl und warmfesten Legierungen mit geringen Vorschüben und Spantiefen. Kontrollierter Spanbruch. Niedrige Schnittkräfte.



- PS

Periphery ground insert which as uncoated version is for finishing none ferrous materials. As coated version, for finishing stainless steel and heat resistant alloys with low feed rates and depth of cut. Controlled chip breaking. Low cutting forces.

Schlichtzerspanung
Finishing
Чистовая обработка

einseitig
single sided
односторонняя



- PS

Пластина со шлифованной периферией. Исполнение без покрытия применяется для чистовой обработки материалов не содержащих железа. Исполнение с покрытием применяется для чистовой обработки нержавеющей сталей и жаропрочных сплавов на малых подачах и глубинах резания. Контроль процесса стружкообразования. Низкие силы резания.

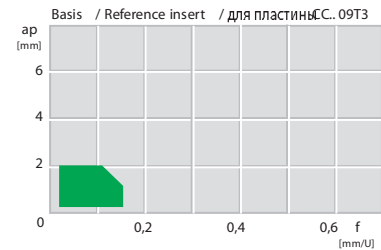

- AEC

Erste Wahl bei der Schlicht- bis hin zur Schruppbearbeitung von Nichteisenmetallen wie Aluminium und Aluminiumlegierungen, Kupfer und Messing. In beschichteter Ausführung auch geeignet zum Schlichten von rostfreien Stählen.



- AEC

First choice for medium to roughing of none ferrous materials, aluminium, aluminium alloys, copper and brass. As coated version very suitable for finishing stainless steel.

Schlicht bis Schruppzerspanung
Finishing to Roughing
От чистовой до черновой обработки

einseitig
single sided
односторонняя



- AEC

Первый выбор для полустивой и черновой обработки материалов не содержащих железа, алюминия, алюминиевых сплавов, меди и бронзы. Исполнение с покрытием хорошо подходит для чистовой обработки нержавеющей сталей.

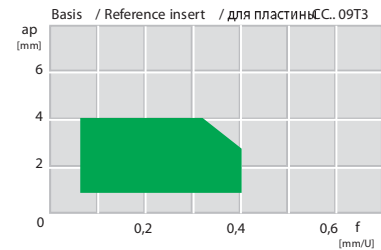



Spanformgeometrien
Chipgroove geometries
Геометрии стружколомов

ARNO®

Bearbeitung NE-Metalle - hochpositiv
None ferrous materials - high positive
- высокопозитивные

1

- AWI

Wiper-Geometrie zum Schlichten bis Schruppen von Aluminium und Aluminiumlegierungen. Auch geeignet zum Schlichten von rostfreien Stählen und exotischen Materialien. Optimierter Spanbruch durch höhere Vorschubwerte.



- AWI

Wiper geometry for finishing to roughing of aluminium and aluminium alloys. Also suitable for finishing stainless steel and exotic materials. Optimum chip breaking because of increased feed rates.

Schlicht bis Schruppzerspanung
Finishing to Roughing
Обработка от чистой до черновой

einseitig
single sided
односторонняя



- AWI

Геометрия Wiper для обработки в диапазоне от чистой до черновой алюминия и его сплавов. Так же используется для чистой обработки нержавеющей сталей и экзотических материалов. Оптимизация процесса стружкообразования на повышенных подачах.

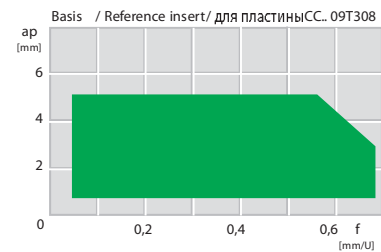

- ASF

Schlichtgeometrie für die Bearbeitung von Aluminium und Aluminiumlegierungen sowie Bunt- und Nichteisenmetalle. Auch geeignet zum Schlichten von rostfreien Stählen. Geringe Schnittkräfte durch die scharfe Schneidkante in Verbindung mit der speziell ausgelegten Spanleitstufe. Wendeschneidplatte komplett umfangsgeschliffen.



- ASF

Finishing geometry for machining aluminium, aluminium alloys and non ferrous materials. Also suitable for finishing stainless steel. Very low cutting forces due to sharp cutting edges and special chip breaker. Completely ground insert.

Schlichtzerspanung
Finishing
Чистовая обработка

einseitig
single sided
односторонняя



- ASF

Геометрия для чистой обработки алюминия и алюминиевых сплавов. Так же применяется для чистой обработки нержавеющей сталей. Очень низкие силы резания благодаря острой режущей кромке и специальной геометрии стружколома. Полностью шлифованная пластина.

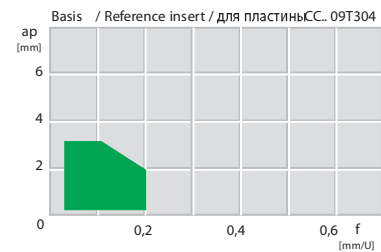

- ALU

Geometrie für die Bearbeitung von Aluminium und Aluminiumlegierungen sowie Bunt- und Nichteisenmetalle. Auch geeignet für die Feinzerspanung von Molybdän, Sinterstahl oder zum Schlichten von rostfreien Stählen. Geringe Schnittkräfte durch die scharfe Schneidkante in Verbindung mit der speziell ausgelegten Spanleitstufe. Dadurch optimale Bearbeitung von labilen, dünnwandigen Teilen möglich. Wendeschneidplatten komplett umfangsgeschliffen.

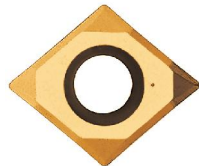

- ALU

Geometry for machining aluminium, alu alloys and non ferrous materials. Also suitable for finishing molybdenum, sintered steel or for stainless steel. Very low cutting forces due to sharp cutting edges and special chip-breaker. Excellent machining of unstable and thin-walled workpieces. Completely ground insert.

Mittlere Zerspanung
Medium cutting
Получистовая обработка

einseitig
single sided
односторонняя



- ALU

Геометрия для обработки алюминия и алюминиевых и цветных сплавов. Так же применяется для окончательной обработки молибдена и нержавеющей сталей. Очень низкие силы резания благодаря острой режущей кромке и специальной геометрии стружколома. Прекрасно подходит для обработки нестабильных и тонкостенных заготовок. Полностью шлифованная пластина.

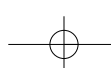
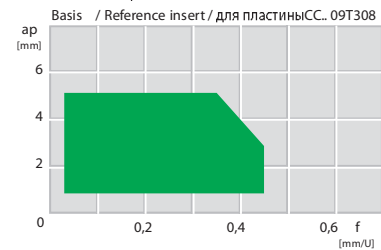



Spanformgeometrien
Chipgroove geometries
Геометрии стружколомов

ARNO®

1

Bearbeitung NE-Metalle
None ferrous materials

- hochpositiv
- high positive
- высокоПОЗИТИВНЫЕ

- ACB

Anwendungsbereich entsprechend der „-ALU“-Geometrie, jedoch mit optimierter Spanform. Zusätzliche Spannoppen für verbesserten Spanbruch und kurze Späne.

- ACB

Same application as „-ALU“ geometry, however with optimized chip-breaker. Special chipbreaker for small chips.

- ACB

Область применения как и у геометрии «ALU», но стружколом оптимизирован для получения мелкосекционной стружки.



Mittlere Zerspanung
Medium cutting
Получистовая обработка

einseitig
single sided
односторонняя

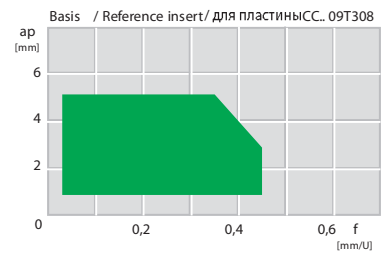



Spanformgeometrien
Chipgroove geometries
Геометрии стружколомов

ARNO®

Cermet
Cermet
Керметы

- positiv
- positive
- ПОЗИТИВНЫЕ

1

- AQ
Geometrie für die Schlichtzerspanung von Stahl, Stahlguss und nichtrostenden Stählen. Bearbeitung mit hoher Oberflächenqualität und Toleranzgenauigkeit. Sehr gute Spanformung.



- AQ
Universal geometry for finishing to medium machining of steel, cast steel and stainless steel. Excellent surface finish and tolerance accuracy. Very good swarf control.

Schlicht und mittlere Zerspanung
Finishing and medium cutting
Чистовая и получистовая обработка

einseitig
single sided
односторонняя

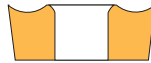

- AQ
Универсальная геометрия для чистовой и получистовой обработки сталей, стального литья и нержавеющей сталей. Отличное качество обработанной поверхности и высокая геометрическая точность. Контроль процесса стружкообразования.

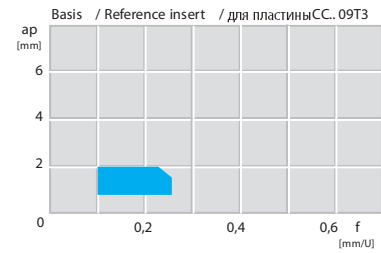

- PMC
Universelle Geometrie für die Bearbeitung von Stahl und Stahlguss, legierten Stählen und nichtrostenden Stählen. Zum Schlichten und für die mittlere Zerspanung geeignet. Guter Spanablauf. In vielen Bearbeitungsbereichen einsetzbar.



- PMC
Universal geometry for machining steel, cast steel, alloy steel and stainless steel. Suitable for finish to medium machining. Because of the wide chip grooves, good swarf control is achieved in most applications.

Schlicht und mittlere Zerspanung
Finishing and medium cutting
Чистовая и получистовая обработка

einseitig
single sided
односторонняя



- PMC
Универсальная геометрия для обработки сталей, стального литья и нержавеющей сталей. Применяется для чистовой и получистовой обработки. Геометрия стружколома обеспечивает хороший контроль процесса стружкообразования в широком диапазоне применения.

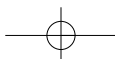
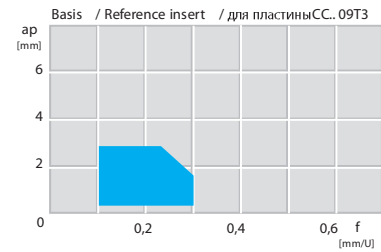



ISO - Anwendungsbereich
ISO - application area
ISO - Область применения

Hartmetall
Carbide
Твёрдый сплав

1

ISO	Hartmetall beschichtet Carbide coated Сплавы без покрытия	Schneidstoff Cutting material Прочность / Износостойкость	Anwendung Application Подача / Скорость
P Stahl, Stahlguss, langspanender Tempergus Steel, cast steel, long chipping malleable iron	10 AK2010 15 AM1520 20 AM5025 25 AM2035 30 AM15C 40 AM15C 50 AM15C	Zähigkeit Toughness / Прочность Verschleißbeständigkeit Wear resistance / Износостойкость Vorschub Feed rate / Подача Schnittgeschwindigkeit Cutting speed / Скорость резания	
M Rostfreier Stahl, Stahlguss, Mangan- stahl, Automatenstahl Stainless steel, cast steel, manganese steel, free cutting steel Нержавеющая сталь, стальное литье, марганцевые стали.	10 AM15C 15 AM15C 20 AM15C 25 AM15C 30 AM15C 35 AM15C 40 AM15C 45 AM15C 50 AM15C	Zähigkeit Toughness / Прочность Verschleißbeständigkeit Wear resistance / Износостойкость Vorschub Feed rate / Подача Schnittgeschwindigkeit Cutting speed / Скорость резания	
K Grauguss, Kokillenhartguss, kurzspanender Tempergus Grey cast iron, chilled hard cast iron, short chipping malleable iron	10 AM15C 15 AM15C 20 AM15C 25 AM15C 30 AM15C 40 AM15C 50 AM15C	Zähigkeit Toughness / Прочность Verschleißbeständigkeit Wear resistance / Износостойкость Vorschub Feed rate / Подача Schnittgeschwindigkeit Cutting speed / Скорость резания	
N Aluminium und Al - Legierungen, nichtmetallische Werkstoffe Aluminium and Al-alloys, non ferrous materials		Zähigkeit Toughness / Прочность Verschleißbeständigkeit Wear resistance / Износостойкость Vorschub Feed rate / Подача Schnittgeschwindigkeit Cutting speed / Скорость резания	
S Warmfeste Legierungen, Titanlegierungen High temperature resistant alloys, Titanium alloys	10 AM2030 15 AM5025 20 AM2035 30 AM2035 40 AM2035 50 AM2035	Zähigkeit Toughness / Прочность Verschleißbeständigkeit Wear resistance / Износостойкость Vorschub Feed rate / Подача Schnittgeschwindigkeit Cutting speed / Скорость резания	
H Gehärteter Stahl, Hartguss Hardened Steel, hard cast iron		Zähigkeit Toughness / Прочность Verschleißbeständigkeit Wear resistance / Износостойкость Vorschub Feed rate / Подача Schnittgeschwindigkeit Cutting speed / Скорость резания	

Hauptanwendungsbereich / Main application area / Область первичного применения

Nebenanwendungsbereich / Secondary application area / Область вторичного применения

AM2030 — Sorte / Grade / Сплав

AM2035 — Sorte / Grade / Сплав

Empfohlener Anwendungsbereich / Recommended application area / Рекомендуемый диапазон

Empfohlener Anwendungsbereich / Recommended application area / Рекомендуемый диапазон



ISO - Anwendungsbereich
ISO - application area
ISO - Область применения

Hartmetall
Carbide
Твёрдый сплав

ISO	Hartmetall unbeschichtet Carbide uncoated Сплавы без покрытия	Schneidstoff Cutting material Прочность / Износостойкость	Anwendung Application Подача / Скорость
P Stahl, Stahlguss, langspanender Temperguss Steel, cast steel, long chipping malleable iron	10	Zähigkeit Toughness / Прочность Verschleißbeständigkeit Wear resistance / Износостойкость	Vorschub Feed rate / Подача Schnittgeschwindigkeit Cutting speed / Скорость
	20		
	30		
	40		
	50		
M Rostfreier Stahl, Stahlguss, Mangan- stahl, Automatenstahl Stainless steel, cast steel, manganese steel, free cutting steel Нержавеющая сталь, стальное литье, марганцевые стали.	10	Zähigkeit Toughness / Прочность Verschleißbeständigkeit Wear resistance / Износостойкость	Vorschub Feed rate / Подача Schnittgeschwindigkeit Cutting speed / Скорость
	20		
	30		
	40		
	50		
K Grauguss, Kokillenhartguss, kurzspanender Temperguss Grey cast iron, chilled hard cast iron, short chipping malleable iron	10	Zähigkeit Toughness / Прочность Verschleißbeständigkeit Wear resistance / Износостойкость	Vorschub Feed rate / Подача Schnittgeschwindigkeit Cutting speed / Скорость
	20		
	30		
	40		
	50		
N Aluminium und Al - Legierungen, nichtmetallische Werkstoffe Aluminium and Al-alloys, non ferrous materials	10	Zähigkeit Toughness / Прочность Verschleißbeständigkeit Wear resistance / Износостойкость	Vorschub Feed rate / Подача Schnittgeschwindigkeit Cutting speed / Скорость
	20		
	30		
	40		
	50		
S Warmfeste Legierungen, Titanlegierungen High temperature resistant alloys, Titanium alloys	10	Zähigkeit Toughness / Прочность Verschleißbeständigkeit Wear resistance / Износостойкость	Vorschub Feed rate / Подача Schnittgeschwindigkeit Cutting speed / Скорость
	20		
	30		
	40		
	50		
H Gehärteter Stahl, Hartguss Hardened Steel, hard cast iron	10	Zähigkeit Toughness / Прочность Verschleißbeständigkeit Wear resistance / Износостойкость	Vorschub Feed rate / Подача Schnittgeschwindigkeit Cutting speed / Скорость
	20		
	30		
	40		
	50		

1

Hauptanwendungsbereich / Main application area // Область первичного применения

Nebenanwendungsbereich / Secondary application area // Область вторичного применения

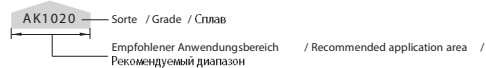



Wendeschneidplatten - Übersicht
 Indexable inserts - Program overview
 Сменные пластины - Обзор

1

Wendeschneidplatten - Hartmetall
 Indexable inserts - Carbide 1.59 - 1.70
 Сменные пластины - Твердый сплав

Wendeschneidplatten - Hochpositiv
 Indexable inserts - High positive 1.71 - 1.81
 Сменные пластины - Высокопозитивные

Wendeschneidplatten - Cermet
 Indexable inserts - Cermet 1.82 - 1.92
 Сменные пластины - Кермет



Wendeschneidplatten
Indexable inserts
Сменные пластины

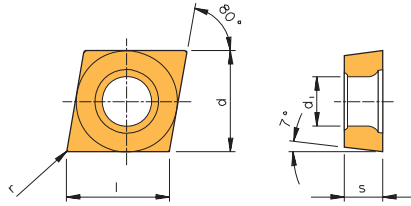

Hartmetall
Carbide
Твёрдый сплав

CC..



	l	d	s	d ₁
CC..06...	6,45	6,350	2,38	2,8
CC..09...	9,67	9,525	3,97	4,4
CC..12...	12,90	12,700	4,76	5,5

1

Bezeichnung Designation Обозначение	Sorten / Grades / Сплавы																						
	beschichtet / coated / с покрытием													unbeschichtet / uncoated / без покрытия									
	AK2010	AM2030	AM2035	AM5020	AM5025	AP2015	AP2025	AP2030	AP2035	AL355	AM15C	AM25C	AM350	AM35C	AR170	AR270	AR27C	AR370	AK1010	AK1020	AP1020	AK10	AK20
CCGT																							
 CCGT 060201FN-PS					●															●			
060202FN-PS					●															●			
060204FN-PS					●															●			
CCGT 09T301FN-PS					●															●			
09T302FN-PS					●															●			
09T304FN-PS					●															●			
CCGW																							
 CCGW 060201FN																				●			
060202FN																				●			
060204FN																				●			
CCGW 09T302FN																				●			
09T304FN																				●			
09T308FN																				●			
CCGX																							
 CCGX 060200FL					●																		●
060200FR					●																		●
060201FL					●																		●
060201FR					●																		●
060202FL					●																		●
060202FR					●																		●
060204FL					●																		●
060204FR					●																		●
CCGX 09T300FL					●																		●
09T300FR					●																		●
09T301FL					●																		●
09T301FR					●																		●
09T302FL					●																		●
09T302FR					●																		●
09T304FL					●																		●
09T304FR					●																		●
	P				○																		
	M				●																		
	K				○															○			○
	N				●																		●
	S				○																		
	H																						



Wendeschneidplatten
Indexable inserts
Сменные пластины

Hartmetall
Carbide
Твёрдый сплав

1

CC..

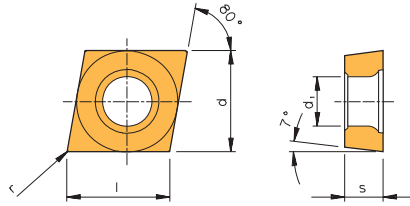

	l	d	s	d ₁
CC..06...	6,45	6,350	2,38	2,8
CC..09...	9,67	9,525	3,97	4,4
CC..12...	12,90	12,700	4,76	5,5

Bezeichnung Designation Обозначение	Sorten / Grades / Сплавы																							
	beschichtet / coated / с покрытием														unbeschichtet / uncoated / без покрытия									
	AK2010	AM2030	AM2035	AM5020	AM5025	AP2015	AP2025	AP2030	AP2035	AL355	AM15C	AM25C	AM350	AM35C	AR170	AR270	AR27C	AR370	AK1010	AK1020	AP1020	AK10	AK20	
CCMT																								
CCMT 060202EN-AB							●	●																
060204EN-AB							●	●																
CCMT 09T302EN-AB							●	●																
09T304EN-AB							●	●																
CCMT 060204EN-AM			●				●	●	●															
060208EN-AM			●				●	●	●															
CCMT 09T304EN-AM		●	●				●	●	●															
09T308EN-AM		●	●				●	●	●															
CCMT 120404EN-AM			●				●	●	●															
120408EN-AM			●				●	●	●															
120412EN-AM			●				●	●	●															
CCMT 060204EN-PMS	●						●	●	●															
060208EN-PMS	●						●	●	●															
CCMT 09T304EN-PMS	●						●	●	●															
09T308EN-PMS	●						●	●	●															
CCMT 120408EN-PMS	●						●	●	●															
CCMT 060202EN-PS1			●				●	●	●															
060204EN-PS1			●				●	●	●															
CCMT 09T302EN-PS1			●				●	●	●															
09T304EN-PS1			●				●	●	●															
09T308EN-PS1			●				●	●	●															
CCMX Wiper																								
CCMX 09T304EN-WMS		●						●																
09T308EN-WMS		●						●																
CCXT																								
CCXT 060202EN-AEC				●																				
060204EN-AEC				●																				
CCXT 09T302EN-AEC				●																				
09T304EN-AEC				●																				
09T308EN-AEC				●																				
	P	○	○	○			●	●	●															
	M		●	●	●		○	○	○															
	K	●					○	●	○															
	N																							
	S		○	●			○		○															
	H																							



Wendeschneidplatten
Indexable inserts
Сменные пластины

Hartmetall
Carbide
Твёрдый сплав

CC..

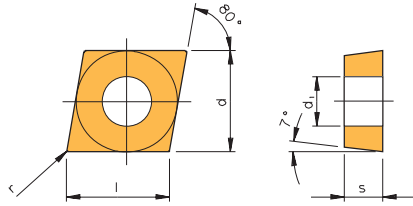

	l	d	s	d ₁
CC.. 12...	12,90	12,700	4,76	5,5

Bezeichnung Designation Обозначение	Sorten / Grades / Сплавы																									
	beschichtet / coated / с покрытием													unbeschichtet / uncoated / без покрытия												
	AK2010	AM2030	AM2035	AM5020	AM5025	AP2015	AP2025	AP2030	AP2035	AL355	AM15C	AM25C	AM350	AM35C	AR170	AR270	AR27C	AR370	AK1010	AK1020	AP1020	AK10	AK20			
CCMX CCMX 120404EN 120408EN														•												
	P													•												
	M													•												
	K													•												
	N													•												
	S													•												
	H													•												

CD..

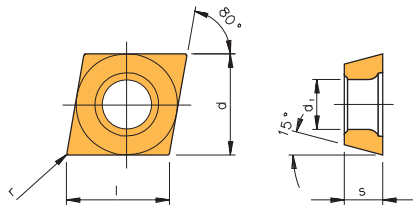

	l	d	s	d ₁
CD.. 04...	4,03	3,97	1,0	2,1

Bezeichnung Designation Обозначение	Sorten / Grades / Сплавы																									
	beschichtet / coated / с покрытием													unbeschichtet / uncoated / без покрытия												
	AK2010	AM2030	AM2035	AM5020	AM5025	AP2015	AP2025	AP2030	AP2035	AL355	AM15C	AM25C	AM350	AM35C	AR170	AR270	AR27C	AR370	AK1010	AK1020	AP1020	AK10	AK20			
CDGT CDGT 040101FL 040101FR 040102FL 040102FR 040104FL 040104FR											•													•		
CDGW CDGW 040101EN 040102EN											•													•		
	P													•												
	M													•												
	K													•												•
	N													•												•
	S													•												•
	H													•												•

Achtung: Bezeichnung entspricht nicht der ISO-Norm
Attention: Designation does not correspond to ISO-designation
Внимание: Данное обозначение не соответствует обозначению по ISO

1



Wendeschneidplatten
Indexable inserts
Сменные пластины

Hartmetall
Carbide
Твердый сплав

CP..

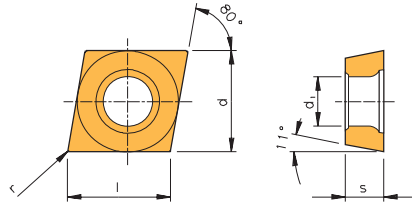

	l	d	s	d ₁
CP..05...	5,60	5,56	1,98	2,5

1

Bezeichnung Designation Обозначение	Sorten / Grades / Сплав																						
	beschichtet / coated / с покрытием														unbeschichtet / uncoated / без покрытия								
	AK2010	AM2030	AM2035	AM5020	AM5025	AP2015	AP2025	AP2030	AP2035	AL355	AM15C	AM25C	AM350	AM35C	AR170	AR270	AR27C	AR370	AK1010	AK1020	AP1020	AK10	AK20
CPET 05T102FL 05T102FR											●												●
CPGT 05T102EN 05T104EN											●												●
CPGW 05T102EN 05T104EN											●												●
CPMT 05T102EN 05T104EN											●												●
											○	●											
											●												
											○	○											○
																							●



Wendeschneidplatten
Indexable inserts
Сменные пластины

Hartmetall
Carbide
Твердый сплав

DC..

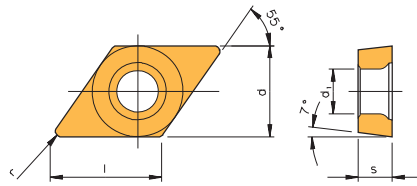

	l	d	s	d ₁
DC..07...	7,75	6,350	2,38	2,8
DC..11...	11,60	9,525	3,97	4,4

1

Bezeichnung Designation Обозначение	Sorten / Grades / Сплав																							
	beschichtet / coated / с покрытием														unbeschichtet / uncoated / без покрытия									
	AK2010	AM2030	AM2035	AM5020	AM5025	AP2015	AP2025	AP2030	AP2035	AL355	AM15C	AM25C	AM350	AM35C	AR170	AR270	AR27C	AR370	AK1010	AK1020	AP1020	AK10	AK20	
DCGT 	DCGT 070201FN-PS				●															●				
	070202FN-PS				●															●				
	070204FN-PS				●															●				
	DCGT 11T301FN-PS				●															●				
	11T302FN-PS				●															●				
	11T304FN-PS				●															●				
DCGW 	DCGW 070201FN																			●				
	070202FN																			●				
	070204FN																			●				
	DCGW 11T302FN																			●				
	11T304FN																			●				
	11T308FN																			●				
DCMT 	DCMT 070202EN-AB						●		●															
	070204EN-AB						●		●															
	DCMT 11T302EN-AB						●		●															
	11T304EN-AB						●		●															
	DCMT 070204EN-AM			●			●	●	●															
	070208EN-AM			●			●	●	●															
	DCMT 11T304EN-AM		●	●			●	●	●															
	11T308EN-AM		●	●			●	●	●															
	DCMT 070204EN-PMS	●					●	●	●															
	DCMT 11T304EN-PMS	●					●	●	●															
	11T308EN-PMS	●					●	●	●															
	DCMT 070202EN-PS1			●			●	●	●															
	070204EN-PS1		●	●			●	●	●															
	DCMT 11T302EN-PS1		●	●			●	●	●															
	11T304EN-PS1		●	●			●	●	●															
	11T308EN-PS1		●	●			●	●	●															
DCMX Wiper 	DCMX 070204EN-WMS		●					●																
	DCMX 11T304EN-WMS		●					●																
	11T308EN-WMS		●					●																
	P	○		○		○	●	●	●	●														
	M		●	●		●	○	○	○	○														
	K	●				○	○	○	○											○				
	N																			●				
	S		○	●		○	○		○															
	H																							



Wendeschneidplatten
Indexable inserts
Сменные пластины

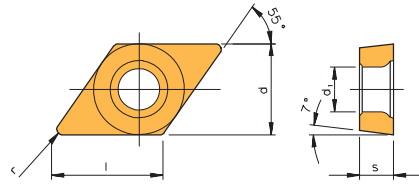

Hartmetall
Carbide
Твердый сплав

DC..



	l	d	s	d ₁
DC.. 07...	7,75	6,350	2,38	2,8
DC.. 11...	11,60	9,525	3,97	4,4

1

Bezeichnung Designation Обозначение	Sorten / Grades / Сплав																							
	beschichtet / coated / с покрытием															unbeschichtet / uncoated / без покрытия								
	AK2010	AM2030	AM2035	AM5020	AM5025	AP2015	AP2025	AP2030	AP2035	AL355	AM15C	AM25C	AM350	AM35C	AR170	AR270	AR27C	AR370	AK1010	AK1020	AP1020	AK10	AK20	
DCGX																								
 DCGX 070200FL					●																			●
070200FR					●																			●
070201FL					●																			●
070201FR					●																			●
070202FL					●																			●
070202FR					●																			●
DCGX 11T300FL					●																			●
11T300FR					●																			●
11T301FL					●																			●
11T301FR					●																			●
11T302FL					●																			●
11T302FR					●																			●
11T304FL					●																			●
11T304FR					●																			●
DCXT																								
 DCXT 070202EN-AEC				●																				
070204EN-AEC				●																				
DCXT 11T302EN-AEC				●																				
11T304EN-AEC				●																				
11T308EN-AEC				●																				
	P			○	○																			
	M			●																				
	K				○																			○
	N																							●
	S				○																			
	H																							



Wendeschneidplatten
Indexable inserts
Сменные пластины

Hartmetall
Carbide
Твердый сплав

KC..

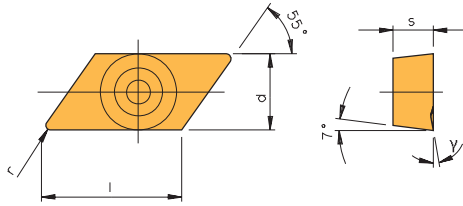

	l	d	s	γ
KC..11...	11,6	6,35	3,18	10°

1

Bezeichnung Designation Обозначение	Sorten / Grades / Сплав																							
	beschichtet / coated / с покрытием													unbeschichtet / uncoated / без покрытия										
	AK2010	AM2030	AM2035	AM5020	AM5025	AP2015	AP2025	AP2030	AP2035	AL355	AM15C	AM25C	AM350	AM35C	AR170	AR270	AR27C	AR370	AK1010	AK1020	AP1020	AK10	AK20	
KCGX  KCGX 110302EL 110302ER 110302FL 110302FR 110304EL 110304ER 110304FL 110304FR 110308EL 110308ER														●										
														●										
														○										
																							○	
																							●	



Wendeschneidplatten
Indexable inserts
Сменные пластины

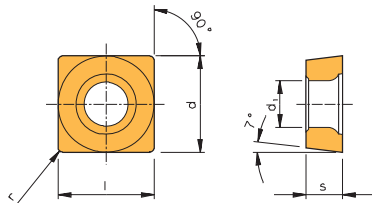

Hartmetall
Carbide
Твердый сплав

SC..



	l	d	s	d ₁
SC..09...	9,525	9,525	3,97	4,4
SC..12...	12,700	12,700	4,76	5,5

1

Bezeichnung Designation Обозначение	Sorten / Grades / Сплав																unbeschichtet / uncoated / без покрытия						
	beschichtet / coated / с покрытием																						
	AK2010	AM2030	AM2035	AM5020	AM5025	AP2015	AP2025	AP2030	AP2035	AL355	AM15C	AM25C	AM350	AM35C	AR170	AR270	AR27C	AR370	AK1010	AK1020	AP1020	AK10	AK20
SCMT																							
 SCMT 09T304EN-AM			●				●		●														
09T308EN-AM							●		●														
 SCMT 120404EN-AM			●				●		●														
120408EN-AM			●				●		●														
120412EN-AM							●		●														
SCMT 09T304EN-PMS						●			●														
09T308EN-PMS						●			●														
 SCMT 120404EN-PMS						●			●														
120408EN-PMS						●	●		●														
120412EN-PMS			●						●														
P			○			●	●		●														
M			●			○	○		○														
K						○	●																
N																							
S			●			○			○														
H																							



Wendeschneidplatten
Indexable inserts
Сменные пластины

Hartmetall
Carbide
Твердый сплав

TC..

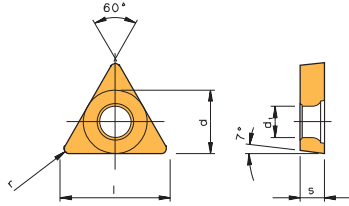

	l	d	s	d ₁
TC.. 06...	6,35	3,97	1,98	2,34
TC.. 09...	9,60	5,56	2,38	2,50
TC.. 11...	11,00	6,35	2,38	2,80
TC.. 16...	16,50	9,525	3,97	4,40

1

Bezeichnung Designation Обозначение	Sorten / Grades / Сплав																						
	beschichtet / coated / с покрытием														unbeschichtet / uncoated / без покрытия								
	AK2010	AM2030	AM2035	AM5020	AM5025	AP2015	AP2025	AP2030	AP2035	AL355	AM15C	AM25C	AM350	AM35C	AR170	AR270	AR27C	AR370	AK1010	AK1020	AP1020	AK10	AK20
TCGW																							
TCGW 06T101FN																				●			
06T102FN																				●			
06T104FN																				●			
TCGW 090202FN																				●			
090204FN																				●			
TCGW 110202FN																				●			
110204FN																				●			
TCMT																							
TCMT 090204EN-AM		●				●		●															
TCMT 110204EN-AM		●				●		●															
110208EN-AM		●				●		●															
TCMT 16T304EN-AM		●				●		●															
16T308EN-AM		●				●		●															
TCMT 110204EN-PMS						●	●	●															
TCMT 16T304EN-PMS						●	●	●															
16T308EN-PMS						●	●	●															
TCMT 110202EN-PS1		●					●																
110204EN-PS1		●					●																
TCMT 16T304EN-PS1		●					●													○			
16T308EN-PS1		●					●													○			
		P	○			●	●	●															
		M	●			○	○	○															
		K				○	●													○			
		N																		●			
		S	●			○		○															
		H																					

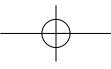



Wendeschneidplatten
Indexable inserts
Сменные пластины



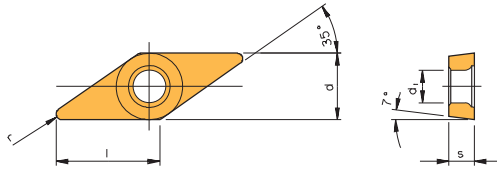

Hartmetall
Carbide
Твердый сплав

VC..



	l	d	s	d ₁
VC.. 07...	6,921	3,970	2,38	2,2
VC.. 11...	11,100	6,350	3,18	2,8
VC.. 13...	13,100	7,940	3,18	3,2
VC.. 16...	16,500	9,525	4,76	4,4



Bezeichnung Designation Обозначение	Sorten / Grades / Сплав																							
	beschichtet / coated / с покрытием															unbeschichtet / uncoated / без покрытия								
	AK2010	AM2030	AM2035	AM5020	AM5025	AP2015	AP2025	AP2030	AP2035	AL355	AM15C	AM25C	AM350	AM35C	AR170	AR270	AR27C	AR370	AK1010	AK1020	AP1020	AK10	AK20	
VCGT																								
 VCGT 110301FN-PS					●																●			
110302FN-PS					●																●			
110304FN-PS					●																●			
 VCGT 160401FN-PS					●																●			
160402FN-PS					●																●			
160404FN-PS					●																●			
 VCGT 070202EN										●														●
070204EN										●														●
 VCGT 070200FL										●														●
070200FR										●														●
070201FL										●														●
070201FR										●														●
070202FL										●														●
070202FR										●														●
VCGW																								
 VCGW 070200EL										●														●
070200ER										●														●
070201EN										●														●
070202EN										●														●
070204EN										●														●
VCGW 110301FN																					●			
110302FN																					●			
110304FN																					●			
VCGW 130302FN																					●			
130304FN																					●			
VCGW 160402FN																					●			
160404FN																					●			
160408FN																					●			
	P				○					○														
	M				●					●														
	K				○					○											○			○
	N																				●			●
	S				○																			
	H																							



Wendeschneidplatten
Indexable inserts
Сменные пластины

Hartmetall
Carbide
Твердый сплав

VC..

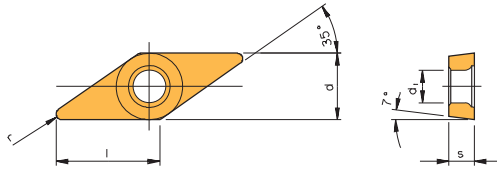

	l	d	s	d ₁
VC.. 07...	6,921	3,970	2,38	2,2
VC.. 11...	11,100	6,350	3,18	2,8
VC.. 13...	13,100	7,940	3,18	3,2
VC.. 16...	16,500	9,525	4,76	4,4

1

Bezeichnung Designation Обозначение	Sorten / Grades / Сплав																unbeschichtet / uncoated / без покрытия						
	beschichtet / coated / с покрытием																						
	AK2010	AM2030	AM2035	AM5020	AM5025	AP2015	AP2025	AP2030	AP2035	AL355	AM15C	AM25C	AM350	AM35C	AR170	AR270	AR27C	AR370	AK1010	AK1020	AP1020	AK10	AK20
VCGX																							
VCGX 110300FL					●																		●
VCGX 110300FR					●																		●
VCGX 110301FL					●																		●
VCGX 110301FR					●																		●
VCGX 110302FL					●																		●
VCGX 110302FR					●																		●
VCGX 110304FL					●																		●
VCGX 110304FR					●																		●
VCGX 130301FL					●																		●
VCGX 130301FR					●																		●
VCGX 130302FL					●																		●
VCGX 130302FR					●																		●
VCGX 130304FL					●																		●
VCGX 130304FR					●																		●
VCMT																							
VCMT 110302EN-AB							●		●														
VCMT 110304EN-AB							●		●														
VCMT 160404EN-AB							●		●														
VCMT 110304EN-AM		●	●					●	●														
VCMT 110308EN-AM								●	●														
VCMT 160404EN-AM		●	●					●	●														
VCMT 160408EN-AM		●	●					●	●														
VCMT 160412EN-AM				●				●	●														
VCMT 110304EN-PMS		●						●	●														
VCMT 160404EN-PMS		●						●	●														
VCMT 160408EN-PMS		●						●	●														
VCMT 110302EN-PS1				●																			
VCMT 110304EN-PS1		●	●																				
VCMT 160404EN-PS1		●	●					●															
VCMT 160408EN-PS1		●	●					●															
VCXT																							
VCXT 110302EN-AEC				●																			
VCXT 110304EN-AEC				●																			
VCXT 160404EN-AEC				●																			
VCXT 160408EN-AEC				●																			
	P	○	○	○	○	○	●	●	●														
	M		●	●	●	●	○	○	○														
	K	●				○	●	○															○
	N																						●
	S		○	●		○			○														
	H																						



Wendeschneidplatten
Indexable inserts
Сменные пластины

Hartmetall
Carbide
Твердый сплав

WC..

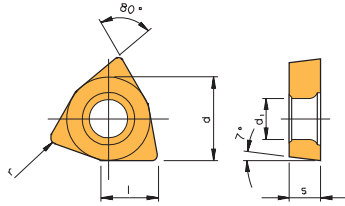

	l	d	s	d ₁
WC.. 02...	2,70	3,970	1,59	2,2
WC.. 04...	4,30	6,350	2,38	2,8
WC.. 06...	6,50	9,525	3,97	4,4
WC.. 08...	8,72	12,700	4,76	5,5

1

Bezeichnung Designation Обозначение	Sorten / Grades / Сплав																						
	beschichtet / coated / с покрытием														unbeschichtet / uncoated / без покрытия								
	AK2010	AM2030	AM2035	AM5020	AM5025	AP2015	AP2025	AP2030	AP2035	AL355	AM15C	AM25C	AM350	AM35C	AR170	AR270	AR27C	AR370	AK1010	AK1020	AP1020	AK10	AK20
WCGT																							
WCGT 020101EN																							
WCGT 020102EN																							
WCGT 020104EN																							
WCGT 020101FL																							
WCGT 020101FL																							
WCGT 020101FR																							
WCGT 020102FL																							
WCGT 020102FR																							
WCGT 020104FL																							
WCGT 020104FR																							
WCGW																							
WCGW 020101EN																							
WCGW 020102EN																							
WCGW 020104EN																							
WCMT																							
WCMT 020102EN																							
WCMT 020104EN																							
WCMT 040204EN-AM																							
WCMT 06T304EN-AM																							
WCMT 06T308EN-AM																							
WCMT 080404EN-AM																							
WCMT 080408EN-AM																							
	P																						
	M																						
	K																						
	N																						
	S																						
	H																						



ISO - Anwendungsbereich
ISO - application area
ISO - Область применения

Hochpositiv
High positive
Высокопозитивные

ISO	Hartmetall beschichtet Carbide coated Сплавы с покрытием	Hartmetall unbeschichtet Carbide uncoated Сплавы без покрытия	Schneidstoff Cutting material Прочность / Износостойкость	Anwendung Application Подача / Скорость
P Stahl, Stahlguss, langspanender Tempergus Steel, cast steel, long chipping malleable iron	10	AL10, AL20, AT10, AT20		
	20		Zähigkeit / Toughness	Vorschub / Feed rate
	30		Verschleißbeständigkeit / Wear resistance	Schneidgeschwindigkeit / Cutting speed
	40			
	50			
M Rostfreier Stahl, Stahlguss, Mangan- stahl, Automatenstahl Stainless steel, cast steel, manganese steel, free cutting steel Нержавеющая сталь, стальное литье, марганцевые стали.	10	AT10, AT20		
	20		Zähigkeit / Toughness	Vorschub / Feed rate
	30		Verschleißbeständigkeit / Wear resistance	Schneidgeschwindigkeit / Cutting speed
	40			
	50			
K Grauguss, Kokillenhartguss, kurzspanender Tempergus Grey cast iron, chilled hard cast iron, short chipping malleable iron	10	AL10, AL20, AT10, AT20		
	20		Zähigkeit / Toughness	Vorschub / Feed rate
	30		Verschleißbeständigkeit / Wear resistance	Schneidgeschwindigkeit / Cutting speed
	40			
	50			
N Aluminium und Al - Legierungen, nichtmetallische Werkstoffe Aluminium and Al-alloys, non ferrous materials	10			
	20		Zähigkeit / Toughness	Vorschub / Feed rate
	30		Verschleißbeständigkeit / Wear resistance	Schneidgeschwindigkeit / Cutting speed
	40			
	50			
S Warmfeste Legierungen, Titanlegierungen High temperature resistant alloys, Titanium alloys	10	AMS025, AT10, AT20		
	20		Zähigkeit / Toughness	Vorschub / Feed rate
	30		Verschleißbeständigkeit / Wear resistance	Schneidgeschwindigkeit / Cutting speed
	40			
	50			
H Gehärteter Stahl, Hartguss	10			
	20		Zähigkeit / Toughness	Vorschub / Feed rate
	30		Verschleißbeständigkeit / Wear resistance	Schneidgeschwindigkeit / Cutting speed
	40			
	50			

1

Hauptanwendungsbereich / Main application area / Область первичного применения

Nebenanwendungsbereich / Secondary application area / Область вторичного применения





Wendeschneidplatten
Indexable inserts
Сменные пластины

Hochpositiv
High positive
Высокопозитивные

CC..

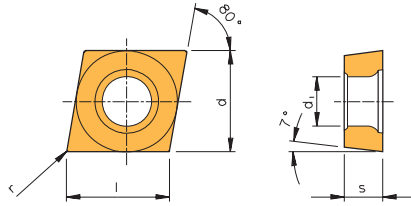

	l	d	s	d ₁
CC..06...	6,45	6,350	2,38	2,8
CC..09...	9,67	9,525	3,97	4,4
CC..12...	12,90	12,700	4,76	5,5



Bezeichnung Designation Обозначение	Sorten / Grades / Сплав												
	beschichtet / coated / с покрытием										unbeschichtet / uncoated / без покрытия		
	AM15C	AM5015	AM5025	AL10	AL20	AT10	AT20	PVD1	PVD2	AD2	AK10	AK20	AP1020
CCGT													
 CCGT 0602005FN-ALU				•	•	•	•	•	•	•	•	•	
060201FN-ALU				•	•	•	•	•	•	•	•	•	
060201EN-ALU	•	•											
060202FN-ALU				•	•	•	•	•	•	•	•	•	
060202EN-ALU	•	•											
060204FN-ALU				•	•	•	•	•	•	•	•	•	
060204EN-ALU	•	•											
CCGT 09T301FN-ALU				•	•	•	•	•	•	•	•	•	
09T301EN-ALU	•	•											
09T302FN-ALU				•	•	•	•	•	•	•	•	•	
09T302EN-ALU	•	•											
09T304FN-ALU				•	•	•	•	•	•	•	•	•	
09T304EN-ALU	•	•											
09T308FN-ALU				•	•	•	•	•	•	•	•	•	
09T308EN-ALU	•	•											
CCGT 120401FN-ALU				•	•	•	•	•	•	•	•	•	
120401EN-ALU	•	•											
120402FN-ALU				•	•	•	•	•	•	•	•	•	
120402EN-ALU	•	•											
120404FN-ALU				•	•	•	•	•	•	•	•	•	
120404EN-ALU	•	•											
120408FN-ALU				•	•	•	•	•	•	•	•	•	
120408EN-ALU	•	•											
CCGT 060202FN-AWI				•	•	•	•	•	•	•	•	•	
060204FN-AWI				•	•	•	•	•	•	•	•	•	
060208FN-AWI				•	•	•	•	•	•	•	•	•	
CCGT 09T302FN-AWI				•	•	•	•	•	•	•	•	•	
09T304FN-AWI				•	•	•	•	•	•	•	•	•	
09T308FN-AWI				•	•	•	•	•	•	•	•	•	
CCGT 120404FN-AWI				•	•	•	•	•	•	•	•	•	
120408FN-AWI				•	•	•	•	•	•	•	•	•	
CCGT 060204FN-ACB				•	•	•	•	•	•	•	•	•	
09T304FN-ACB				•	•	•	•	•	•	•	•	•	
09T308FN-ACB				•	•	•	•	•	•	•	•	•	
CCGT 120404FN-ACB				•	•	•	•	•	•	•	•	•	
120408FN-ACB				•	•	•	•	•	•	•	•	•	
CCGT 0602005FN-ASF				•	•	•	•	•	•	•	•	•	
060201FN-ASF				•	•	•	•	•	•	•	•	•	
060201EN-ASF	•												
060202FN-ASF	•			•	•	•	•	•	•	•	•	•	
060202EN-ASF	•		•										•
060204FN-ASF				•	•	•	•	•	•	•	•	•	
060204EN-ASF			•										•
CCGT 09T3005FN-ASF				•	•	•	•	•	•	•	•	•	
09T301FN-ASF				•	•	•	•	•	•	•	•	•	
09T302FN-ASF				•	•	•	•	•	•	•	•	•	
09T302EN-ASF	•		•										•
09T304FN-ASF				•	•	•	•	•	•	•	•	•	
09T304EN-ASF	•		•										•
09T308FN-ASF				•	•	•	•	•	•	•	•	•	
				•	•	•	•	•	•	•	•	•	
	P	○	○	•	•	•	•	•	•	•	•	•	•
	M	•	•	•	•	•	•	•	•	•	•	•	•
	K	•	•	○	○	○	○	○	○	○	○	○	○
	N			•	•	•	•	•	•	•	•	•	•
	S			○	○	○	○	○	○	○	○	○	○
	H			○	○	○	○	○	○	○	○	○	○

Alle Abmessungen in mm
Dimensions in mm
Размеры указаны в мм



Wendeschneidplatten
Indexable inserts
Сменные пластины

Hochpositiv
High positive
Высокопозитивные

CC..

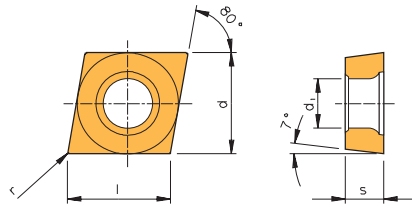

	l	d	s	d ₁
CC..06...	6,45	6,350	2,38	2,8
CC..09...	9,67	9,525	3,97	4,4
CC..12...	12,90	12,700	4,76	5,5

Bezeichnung Designation Обозначение	Sorten / Grades / Сплав											
	beschichtet / coated / с покрытием									unbeschichtet / uncoated / без покрытия		
	AM15C	AM5025	AL10	AL20	AT10	AT20	PVD1	PVD2	AD2	AK10	AK20	AP1020
CCXT 060202FN-AEC										•		
060204FN-AEC										•		
CCXT 09T302FN-AEC										•		
09T304FN-AEC										•		
09T308FN-AEC										•		
P										○		
M										•		
K										○		
N										•		
S												
H												

CD..

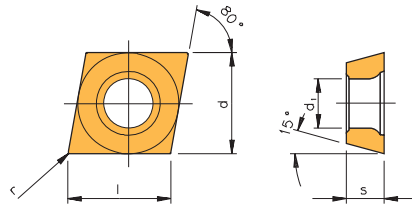

	l	d	s	d ₁
CD..04...	4,03	3,97	1,0	2,1

Bezeichnung Designation Обозначение	Sorten / Grades / Сплав											
	beschichtet / coated / с покрытием									unbeschichtet / uncoated / без покрытия		
	AM15C	AM5025	AL10	AL20	AT10	AT20	PVD1	PVD2	AD2	AK10	AK20	AP1020
CDGT 0401005FN-ALU				•		•					•	
040101FN-ALU				•		•					•	
040102FN-ALU				•		•					•	
040104FN-ALU				•		•					•	
P				•		○						
M				•		○						
K				○		○					○	
N				○		•					•	
S				○								
H				○								

1



Wendeschneidplatten
Indexable inserts
Сменные пластины

Hochpositiv
High positive
Высокопозитивные

1

CN..

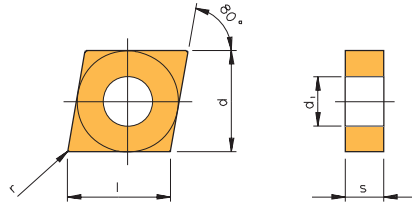

	l	d	s	d ₁
CN.. 16...	16,1	15,875	6,35	6,35
CN.. 19...	19,3	19,050	6,35	7,93

Bezeichnung Designation Обозначение	Sorten / Grades / Сплав											
	beschichtet / coated / с покрытием											
	AM15C	AM5025	AL10	AL20	AT10	AT20	PVD1	PVD2	AD2	unbeschichtet / uncoated / без покрытия		
										AK10	AK20	AP1020
CNGM												
CNGM 160612FN-ALU						●		●			●	
CNGM 190612FN-ALU						●		●			●	
						○		○				
						○		○				
						○		○			○	
						●		●			●	

CP..

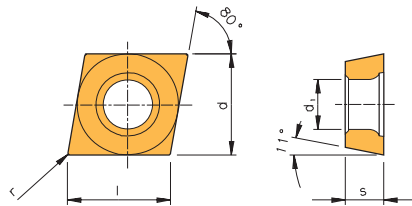

	l	d	s	d ₁
CP.. 05...	5,6	5,56	2,5	2,5

Bezeichnung Designation Обозначение	Sorten / Grades / Сплав											
	beschichtet / coated / с покрытием											
	AM15C	AM5025	AL10	AL20	AT10	AT20	PVD1	PVD2	AD2	unbeschichtet / uncoated / без покрытия		
										AK10	AK20	AP1020
CPGT												
CPGT 05T1005FN-ALU			●	●	●	●	●	●	●	●	●	
05T101FN-ALU			●	●	●	●	●	●	●	●	●	
05T101EN-ALU	●											
05T102FN-ALU			●	●	●	●	●	●	●	●	●	
05T102EN-ALU	●											
05T104FN-ALU			●	●	●	●	●	●	●	●	●	
05T104EN-ALU	●											
CPGT 05T1005FN-ASF			●	●	●	●	●	●	●	●	●	
05T101FN-ASF			●	●	●	●	●	●	●	●	●	
05T102FN-ASF			●	●	●	●	●	●	●	●	●	
05T102EN-ASF		●										●
05T104FN-ASF			●	●	●	●	●	●	●	●	●	
05T104EN-ASF		●										●
			○	○	○	○	○	○	○			●
			●	●	○	○	○	○				
			●	○	○	○	○	○			○	○
			●	○	○	○	○	○			○	○
			○	○	○	○	○	○			○	○
			○	○	○	○	○	○			○	○



Wendeschneidplatten
Indexable inserts
Сменные пластины

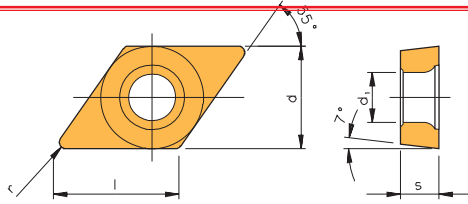

Hochpositiv
High positive
Высокопозитивные

DC..



	l	d	s	d ₁
DC..07...	7,75	6,350	2,38	2,8
DC..11...	11,60	9,525	3,97	4,4

1

Bezeichnung Designation Обозначение	Sorten / Grades / Сплав												
	beschichtet / coated / с покрытием									unbeschichtet / uncoated / без покрытия			
	AM15C	AM5015	AM5025	AL10	AL20	AT10	AT20	PVD1	PVD2	AD2	AK10	AK20	AP1020
DCGT													
 DCGT 0702005FN-ALU				●	●	●	●	●	●	●	●	●	●
070201FN-ALU				●	●	●	●	●	●	●	●	●	●
070201EN-ALU	●												
070202FN-ALU				●	●	●	●	●	●	●	●	●	●
070202EN-ALU	●												
070204FN-ALU				●	●	●	●	●	●	●	●	●	●
070204EN-ALU	●												
DCGT 11T301FN-ALU				●	●	●	●	●	●	●	●	●	●
11T301EN-ALU	●												
11T302FN-ALU				●	●	●	●	●	●	●	●	●	●
11T302EN-ALU	●												
11T304FN-ALU				●	●	●	●	●	●	●	●	●	●
11T304EN-ALU	●												
11T308FN-ALU				●	●	●	●	●	●	●	●	●	●
11T308EN-ALU	●												
11T312FN-ALU											●	●	
DCGT 070202FN-AWI				●		●					●	●	
070204FN-AWI				●		●					●	●	
070208FN-AWI				●		●					●	●	
DCGT 11T302FN-AWI				●		●					●	●	
11T304FN-AWI				●		●					●	●	
11T308FN-AWI				●		●					●	●	
DCGT 070204FN-ACB				●	●	●	●	●	●	●	●	●	●
DCGT 11T304FN-ACB				●	●	●	●	●	●	●	●	●	●
11T308FN-ACB				●	●	●	●	●	●	●	●	●	●
DCGT 0702005FN-ASF				●	●	●	●				●	●	
070201FN-ASF				●	●	●	●				●	●	
070201EN-ASF		●										●	
070202FN-ASF				●	●	●	●		●		●	●	
070202EN-ASF		●	●								●	●	
070204FN-ASF				●	●	●	●		●		●	●	
070204EN-ASF		●	●								●	●	
DCGT 11T3005FN-ASF				●	●	●	●				●	●	
11T301FN-ASF				●	●	●	●				●	●	
11T302FN-ASF				●	●	●	●		●		●	●	
11T302EN-ASF		●	●								●	●	
11T304FN-ASF				●	●	●	●		●		●	●	
11T304EN-ASF		●	●								●	●	
11T308FN-ASF				●	●	●	●				●	●	
11T308EN-ASF		●	●								●	●	
DCXT													
 DCXT 070202FN-AEC											●	●	
070204FN-AEC											●	●	
DCXT 11T302FN-AEC											●	●	
11T304FN-AEC											●	●	
11T308FN-AEC											●	●	
	P	○	○	●	●	○	○	○	○	○	○	○	●
	M	●	●	●	●	○	○	○	○	○	○	○	○
	K	●	○	○	○	○	○	○	○	○	○	○	○
	N					●	●	●	●	●	●	●	●
	S		●	○	○	○	○	○	○	○	○	○	○
	H			○	○								

Alle Abmessungen in mm
Dimensions in mm
Размеры указаны в мм



Wendeschneidplatten
Indexable inserts
Сменные пластины

Hochpositiv
High positive
Высокопозитивные

1

KC..

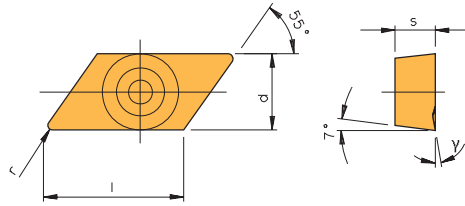

	l	d	s	γ
KC..11...	11,6	6,35	3,18	18°

Bezeichnung Designation Обозначение	Sorten / Grades / Сплав											
	beschichtet / coated / с покрытием									unbeschichtet / uncoated / без покрытия		
	AM15C	AM5025	AL10	AL20	AT10	AT20	PVD1	PVD2	AD2	AK10	AK20	APT020
 KCGX KCGX 110302FL-18 110302FR-18 110304FL-18 110304FR-18 110308FL-18 110308FR-18										●		
										●		
										●		
										●		
										●		
										●		
	P									○		
	M									●		
	K											
	N											
	S											
	H											

SC..

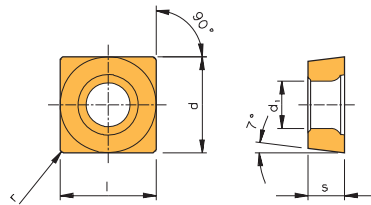

	l	d	s	d ₁
SC..09...	9,525	9,525	3,97	4,4
SC..12...	12,700	12,700	4,76	5,5

Bezeichnung Designation Обозначение	Sorten / Grades / Сплав											
	beschichtet / coated / с покрытием									unbeschichtet / uncoated / без покрытия		
	AM15C	AM5025	AL10	AL20	AT10	AT20	PVD1	PVD2	AD2	AK10	AK20	APT020
 SCGT SCGT 09T304FN-ALU 09T304EN-ALU 09T308FN-ALU 09T308EN-ALU SCGT 120404FN-ALU 120404EN-ALU 120408FN-ALU 120408EN-ALU 120412FN-ALU 120412EN-ALU 120416FN-ALU 120416EN-ALU			●	●	●	●	●	●	●	●	●	
		●		●	●	●	●	●	●	●	●	
				●	●	●	●	●	●	●	●	
		●		●	●	●	●	●	●	●	●	
				●	●	●	●	●	●	●	●	
		●		●	●	●	●	●	●	●	●	
				●	●	●	●	●	●	●	●	
		●		●	●	●	●	●	●	●	●	
				○	○	○	○	○	○			
		●		●	●	○	○	○	○			
	●		○	○	○	○	○	○	○	○		
			○	○					●	●		
			○	○								



Wendeschneidplatten
Indexable inserts
Сменные пластины

Hochpositiv
High positive
Высокопозитивные

TC..

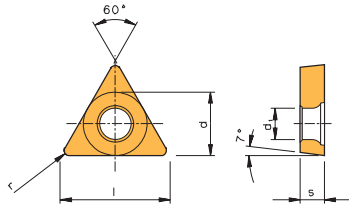

	l	d	s	d ₁
TC..06...	6,9	3,970	1,98	2,3
TC..09...	9,6	5,560	2,38	2,5
TC..11...	11,0	6,350	2,38	2,8
TC..16...	16,5	9,525	3,97	4,4



Bezeichnung Designation Обозначение	Sorten / Grades / Сплав											
	beschichtet / coated / с покрытием									unbeschichtet / uncoated / без покрытия		
	AM15C	AM5025	AL10	AL20	AT10	AT20	PVD1	PVD2	AD2	AK10	AK20	AP1020
TCGT 06T101FN-ALU			•	•	•	•				•	•	
06T102FN-ALU			•	•	•	•				•	•	
06T102EN-ALU	•											
TCGT 090202FN-ALU			•	•	•	•				•	•	
090202EN-ALU	•											
090204FN-ALU			•	•	•	•				•	•	
090204EN-ALU	•											
TCGT 110201FN-ALU			•	•	•	•				•	•	
110201EN-ALU	•											
110202FN-ALU			•	•	•	•				•	•	
110202EN-ALU	•											
110204FN-ALU			•	•	•	•				•	•	
110204EN-ALU	•											
TCGT 16T301FN-ALU			•	•	•	•				•	•	
16T301EN-ALU	•											
16T302FN-ALU			•	•	•	•				•	•	
16T302EN-ALU	•											
16T304FN-ALU			•	•	•	•				•	•	
16T304EN-ALU	•											
16T308FN-ALU			•	•	•	•				•	•	
16T308EN-ALU	•											
16T312FN-ALU			•	•	•	•				•	•	
16T312EN-ALU	•											
16T316FN-ALU			•	•	•	•				•	•	
16T316EN-ALU	•											
TCGT 110204FN-ACB			•	•	•	•				•	•	
TCGT 16T304FN-ACB			•	•	•	•				•	•	
16T308FN-ACB			•	•	•	•				•	•	
TCGT 1102005FN-ASF			•	•	•	•				•	•	
110201FN-ASF			•	•	•	•				•	•	
110202FN-ASF			•	•	•	•				•	•	
110204FN-ASF			•	•	•	•				•	•	
TCGT 16T301FN-ASF			•	•	•	•				•	•	
16T302FN-ASF			•	•	•	•				•	•	
16T304FN-ASF			•	•	•	•				•	•	
	P	○	•	•	○	○	○	○		•	•	
	M	•	•	•	○	○	○	○		•	•	
	K	•	○	○	○	○	○	○		○	○	
	N		•	•	•	•	•	•		•	•	
	S		○	○								
	H		○	○								

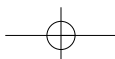



Wendeschneidplatten
Indexable inserts
Сменные пластины

Hochpositiv
High positive
Высокопозитивные

VC..

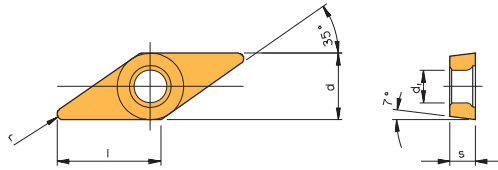

	l	d	s	d ₁
VC. 07...	6,921	3,970	2,38	2,2
VC. 11...	11,100	6,350	3,18	2,9
VC. 13...	13,100	7,940	3,18	3,2
VC. 16...	16,600	9,525	4,76	4,4
VC. 22...	22,100	12,700	5,56	5,5



Bezeichnung Designation Обозначение	Sorten / Grades / Сплав											
	beschichtet / coated / с покрытием									unbeschichtet / uncoated / без покрытия		
	AM15C	AM5025	AL10	AL20	AT10	AT20	PVD1	PVD2	AD2	AK10	AK20	AP1020
VCGT 0702005FN-ALU			●	●	●	●	●	●	●	●	●	●
070201FN-ALU	●		●	●	●	●	●	●	●	●	●	●
070201EN-ALU	●											
070202FN-ALU	●		●	●	●	●	●	●	●	●	●	●
070202EN-ALU	●											
070204FN-ALU	●		●	●	●	●	●	●	●	●	●	●
070204EN-ALU	●											
VCGT 1103005FN-ALU			●	●	●	●	●	●	●	●	●	●
110301FN-ALU	●		●	●	●	●	●	●	●	●	●	●
110301EN-ALU	●											
110302FN-ALU	●		●	●	●	●	●	●	●	●	●	●
110302EN-ALU	●											
110304FN-ALU	●		●	●	●	●	●	●	●	●	●	●
110304EN-ALU	●											
110308FN-ALU	●		●	●	●	●	●	●	●	●	●	●
110308EN-ALU	●											
VCGT 1303005FN-ALU			●	●	●	●	●	●	●	●	●	●
130301FN-ALU	●		●	●	●	●	●	●	●	●	●	●
130301EN-ALU	●											
130302FN-ALU	●		●	●	●	●	●	●	●	●	●	●
130302EN-ALU	●											
130304FN-ALU	●		●	●	●	●	●	●	●	●	●	●
130304EN-ALU	●											
130308FN-ALU	●		●	●	●	●	●	●	●	●	●	●
130308EN-ALU	●											
VCGT 160401FN-ALU			●	●	●	●	●	●	●	●	●	●
160402FN-ALU	●		●	●	●	●	●	●	●	●	●	●
160402EN-ALU	●											
160404FN-ALU	●		●	●	●	●	●	●	●	●	●	●
160404EN-ALU	●											
160408FN-ALU	●		●	●	●	●	●	●	●	●	●	●
160408EN-ALU	●											
160412FN-ALU	●		●	●	●	●	●	●	●	●	●	●
160412EN-ALU	●											
VCGT 220520FN-ALU			●	●	●	●	●	●	●	●	●	●
220530FN-ALU			●	●	●	●	●	●	●	●	●	●
VCGT 110302FN-AWI			●	●	●	●	●	●	●	●	●	●
110304FN-AWI			●	●	●	●	●	●	●	●	●	●
110308FN-AWI			●	●	●	●	●	●	●	●	●	●
VCGT 160404FN-AWI			●	●	●	●	●	●	●	●	●	●
160408FN-AWI			●	●	●	●	●	●	●	●	●	●
	P	○	●	●	○	○	○	○	○	○	○	○
	M	●	●	●	○	○	○	○	○	○	○	○
	K	●	○	○	○	○	○	○	○	○	○	○
	N		○	○	●	●	●	●	●	●	●	●
	S		○	○								
	H		○	○								



Wendeschneidplatten
Indexable inserts
Сменные пластины

Hochpositiv
High positive
Высокопозитивные

VC..

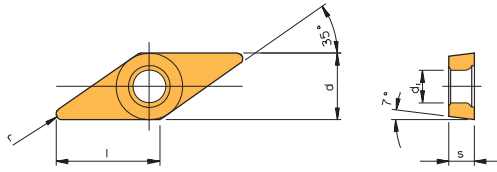

	l	d	s	d ₁
VC.. 07...	6,921	3,970	2,38	2,2
VC.. 11...	11,100	6,350	3,18	2,9
VC.. 13...	13,100	7,940	3,18	3,2
VC.. 16...	16,600	9,525	4,76	4,4
VC.. 22...	22,100	12,700	5,56	5,5



Bezeichnung Designation Обозначение	Sorten / Grades / Сплав												
	beschichtet / coated / с покрытием										unbeschichtet / uncoated / без покрытия		
	AM15C	AM5015	AM5025	AL10	AL20	AT10	AT20	PVD1	PVD2	AD2	AK10	AK20	AP1020
VCGT													
VC GT 110304FN-ACB				●	●	●	●	●	●	●	●	●	●
110308FN-ACB				●	●	●	●	●	●	●	●	●	●
VC GT 130304FN-ACB				●	●	●	●	●	●	●	●	●	●
130308FN-ACB				●	●	●	●	●	●	●	●	●	●
VC GT 160404FN-ACB				●	●	●	●	●	●	●	●	●	●
160408FN-ACB				●	●	●	●	●	●	●	●	●	●
160412FN-ACB				●	●	●	●	●	●	●	●	●	●
VC GT 220520FN-ACB				●	●	●	●	●	●	●	●	●	●
220530FN-ACB				●	●	●	●	●	●	●	●	●	●
VCGT													
VC GT 0702005FN-ASF				●	●	●	●				●	●	
070201FN-ASF				●	●	●	●				●	●	
070202FN-ASF				●	●	●	●				●	●	●
070202EN-ASF			●										●
070204FN-ASF				●	●	●	●				●	●	●
070204EN-ASF			●										●
VC GT 1103005FN-ASF				●	●	●	●				●	●	
110301FN-ASF				●	●	●	●				●	●	
110301EN-ASF		●											●
110302FN-ASF				●	●	●	●				●	●	
110302EN-ASF		●	●										●
110304FN-ASF				●	●	●	●		●		●	●	
110304EN-ASF		●	●										●
VC GT 1303005FN-ASF				●	●	●	●				●	●	
130301FN-ASF				●	●	●	●				●	●	
130301EN-ASF		●											●
130302FN-ASF				●	●	●	●				●	●	
130302EN-ASF		●											●
130304FN-ASF				●	●	●	●				●	●	
130304EN-ASF		●											●
VC GT 160401FN-ASF				●	●	●	●				●	●	
160402FN-ASF				●	●	●	●				●	●	
160402EN-ASF		●	●										●
160404FN-ASF				●	●	●	●		●		●	●	
160404EN-ASF		●	●										●
160408FN-ASF				●	●	●	●				●	●	
VCXT													
VCXT 110302FN-AEC											●		
110304FN-AEC											●		
VCXT 160404FN-AEC											●		
160408FN-AEC											●		
160412FN-AEC											●		
VCXT 220530FN-AEC												●	
	P	●	○	●	●	○	○	○	○				●
	M	●	○	●	●	○	○	○	○				●
	K		○	○	○	○	○	○	○		○	○	
	N		○	○	○	○	○	○	○	●	●	●	
	S	●	○	○	○								
	H		○	○	○								



Wendeschneidplatten
Indexable inserts
Сменные пластины



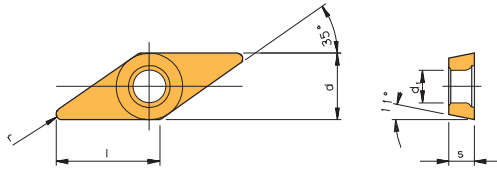

Hochpositiv
High positive
Высокопозитивные

VP..



	l	d	s	d ₁
VP.. 22...	22,1	12,7	5,56	5,5

1

Bezeichnung Designation Обозначение	Sorten / Grades / Сплав											
	beschichtet / coated / с покрытием									unbeschichtet / uncoated / без покрытия		
	AM15C	AM5025	AL10	AL20	AT10	AT20	PVD1	PVD2	AD2	AK10	AK20	AP1020
VPGT												
 VPGT 220512FN-ALU			●	●	●	●				●	●	
220516FN-ALU			●	●	●	●	●	●	●	●	●	
220530FN-ALU											●	
 VPGT 220512FN-ACB			●	●	●	●				●	●	
220516FN-ACB			●	●	●	●	●	●	●	●	●	
 VPGT 220512FN-ASF					●	●				●	●	
VPXT												
 VPXT 220516FN-AEC											●	
220530FN-AEC											●	
			●	●	○	○	○	○				
			●	●	○	○	○	○				
			○	○	○	○	○	○		○	○	
			○	○	●	●	●	●	●	●	●	
			○	○								
			○	○								



Wendeschneidplatten
Indexable inserts
Сменные пластины

Hochpositiv
High positive
Высокопозитивные

WC..

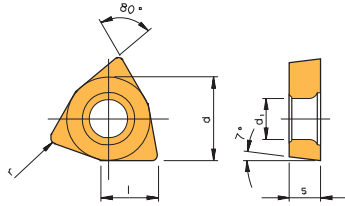

	l	d	s	d ₁
WC.. 02...	2,70	3,970	1,59	2,2
WC.. 03...	3,80	5,560	2,38	2,5
WC.. 04...	4,30	6,350	2,38	2,8
WC.. 06...	6,50	9,525	3,97	4,4
WC.. 08...	8,72	12,700	4,76	5,5

1

Bezeichnung Designation Обозначение	Sorten / Grades / Сплав											
	beschichtet / coated / с покрытием									unbeschichtet / uncoated / без покрытия		
	AM15C	AM5025	AL10	AL20	AT10	AT20	PVD1	PVD2	AD2	AK10	AK20	AP1020
WCGT 0201005FN-ALU				•		•					•	
020101FN-ALU				•		•					•	
020102FN-ALU				•		•					•	
020104FN-ALU				•		•					•	
WCGT 030202FN-ALU	•		•	•	•	•	•	•	•	•	•	
030202EN-ALU	•		•	•	•	•	•	•	•	•	•	
030204FN-ALU	•		•	•	•	•	•	•	•	•	•	
030204EN-ALU	•		•	•	•	•	•	•	•	•	•	
WCGT 040201FN-ALU	•		•	•	•	•	•	•	•	•	•	
040201EN-ALU	•		•	•	•	•	•	•	•	•	•	
040202FN-ALU	•		•	•	•	•	•	•	•	•	•	
040202EN-ALU	•		•	•	•	•	•	•	•	•	•	
040204FN-ALU	•		•	•	•	•	•	•	•	•	•	
040204EN-ALU	•		•	•	•	•	•	•	•	•	•	
WCGT 06T301FN-ALU	•		•	•	•	•	•	•	•	•	•	
06T301EN-ALU	•		•	•	•	•	•	•	•	•	•	
06T302FN-ALU	•		•	•	•	•	•	•	•	•	•	
06T302EN-ALU	•		•	•	•	•	•	•	•	•	•	
06T304FN-ALU	•		•	•	•	•	•	•	•	•	•	
06T304EN-ALU	•		•	•	•	•	•	•	•	•	•	
WCGT 080404FN-ALU	•		•	•	•	•	•	•	•	•	•	
080404EN-ALU	•		•	•	•	•	•	•	•	•	•	
080408FN-ALU	•		•	•	•	•	•	•	•	•	•	
080408EN-ALU	•		•	•	•	•	•	•	•	•	•	
WCGT 040204FN-AWI			•		•					•		
040208FN-AWI			•		•					•		
WCGT 06T304FN-AWI			•		•					•		
06T308FN-AWI			•		•					•		
WCGT 080404FN-AWI			•		•					•		
080408FN-AWI			•		•					•		
WCGT 040204FN-ACB			•	•	•	•	•	•	•	•	•	
WCGT 06T304FN-ACB			•	•	•	•	•	•	•	•	•	
WCGT 080404FN-ACB			•	•	•	•	•	•	•	•	•	
080408FN-ACB			•	•	•	•	•	•	•	•	•	
WCGT 0402005FN-ASF			•	•	•	•				•	•	
040201FN-ASF			•	•	•	•				•	•	
040202FN-ASF			•	•	•	•				•	•	
040204FN-ASF			•	•	•	•				•	•	
WCGT 06T3005FN-ASF			•	•	•	•				•	•	
06T301FN-ASF			•	•	•	•				•	•	
06T302FN-ASF			•	•	•	•				•	•	
06T304FN-ASF			•	•	•	•				•	•	
	P	○	•	•	○	○	○	○	○	•	•	
	M	•	•	•	○	○	○	○	○	•	•	
	K	•	○	○	○	○	○	○	○	○	○	
	N		•	•	•	•	•	•	•	•	•	
	S		○	○								
	H		○	○								

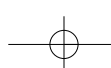



ISO - Anwendungsbereich
ISO - application area
ISO - Область применения

CERMET

1

ISO	CERMET beschichtet CERMET coated Сплав с покрытием	CERMET unbeschichtet CERMET uncoated Сплав без покрытия	Schneidstoff Cutting material Износостойкость / Прочность	Anwendung Application Скорость / Подача							
P Stahl, Stahlguss, langspanender Temperguss Steel, cast steel, long chipping malleable iron	10	AP6010	Zähigkeit Toughness / Прочность	Verschleißbeständigkeit Wear resistance / Износостойкость							
	20				ACE6	Zähigkeit Toughness / Прочность	Verschleißbeständigkeit Wear resistance / Износостойкость				
	30							Zähigkeit Toughness / Прочность	Verschleißbeständigkeit Wear resistance / Износостойкость		
	40									Zähigkeit Toughness / Прочность	Verschleißbeständigkeit Wear resistance / Износостойкость
	50										
M Rostfreier Stahl, Stahlguss, Mangan- stahl, Automatenstahl Stainless steel, cast steel, manganese steel, free cutting steel Нержавеющая сталь, стальное литье, мартенситная сталь.	10	ACE6	Zähigkeit Toughness / Прочность	Verschleißbeständigkeit Wear resistance / Износостойкость							
	20				Zähigkeit Toughness / Прочность	Verschleißbeständigkeit Wear resistance / Износостойкость					
	30						Zähigkeit Toughness / Прочность	Verschleißbeständigkeit Wear resistance / Износостойкость			
	40								Zähigkeit Toughness / Прочность	Verschleißbeständigkeit Wear resistance / Износостойкость	
	50										Zähigkeit Toughness / Прочность
K Grauguss, Kokillenhartguss, kurzspanender Temperguss Grey cast iron, chilled hard cast iron, short chipping malleable iron	10	AP6510	Zähigkeit Toughness / Прочность	Verschleißbeständigkeit Wear resistance / Износостойкость							
	20				Zähigkeit Toughness / Прочность	Verschleißbeständigkeit Wear resistance / Износостойкость					
	30						Zähigkeit Toughness / Прочность	Verschleißbeständigkeit Wear resistance / Износостойкость			
	40								Zähigkeit Toughness / Прочность	Verschleißbeständigkeit Wear resistance / Износостойкость	
	50										Zähigkeit Toughness / Прочность
N Aluminium und Al - Legierungen, nichtmetallische Werkstoffe Aluminium and Al-alloys, non ferrous materials	10	AP6510	Zähigkeit Toughness / Прочность	Verschleißbeständigkeit Wear resistance / Износостойкость							
	20				Zähigkeit Toughness / Прочность	Verschleißbeständigkeit Wear resistance / Износостойкость					
	30						Zähigkeit Toughness / Прочность	Verschleißbeständigkeit Wear resistance / Износостойкость			
	40								Zähigkeit Toughness / Прочность	Verschleißbeständigkeit Wear resistance / Износостойкость	
	50										Zähigkeit Toughness / Прочность
S Warmfeste Legierungen, Titanlegierungen High temperature resistant alloys, Titanium alloys	10	AP6510	Zähigkeit Toughness / Прочность	Verschleißbeständigkeit Wear resistance / Износостойкость							
	20				Zähigkeit Toughness / Прочность	Verschleißbeständigkeit Wear resistance / Износостойкость					
	30						Zähigkeit Toughness / Прочность	Verschleißbeständigkeit Wear resistance / Износостойкость			
	40								Zähigkeit Toughness / Прочность	Verschleißbeständigkeit Wear resistance / Износостойкость	
	50										Zähigkeit Toughness / Прочность
H Gehärteter Stahl, Hartguss	10	AP6510	Zähigkeit Toughness / Прочность	Verschleißbeständigkeit Wear resistance / Износостойкость							
	20				Zähigkeit Toughness / Прочность	Verschleißbeständigkeit Wear resistance / Износостойкость					
	30						Zähigkeit Toughness / Прочность	Verschleißbeständigkeit Wear resistance / Износостойкость			
	40								Zähigkeit Toughness / Прочность	Verschleißbeständigkeit Wear resistance / Износостойкость	
	50										Zähigkeit Toughness / Прочность

Hauptanwendungsbereich / Main application area / Область первичного применения

Nebenanwendungsbereich / Secondary application area / Область вторичного применения

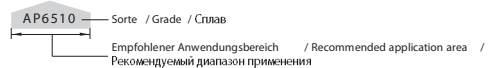
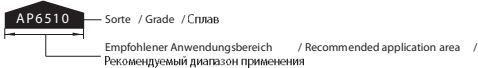



Wendeschneidplatten
Indexable inserts
Сменные пластины

CERMET

CC..

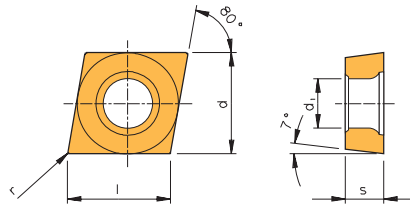

	l	d	s	d ₁
CC..06...	6,40	6,350	2,38	2,8
CC..09...	9,70	9,525	3,97	4,4
CC..12...	12,90	12,700	4,76	5,5

1

Bezeichnung Designation Обозначение	Sorten / Grades / Сплав					
	beschichtet / coated / с покрытием			unbeschichtet / uncoated / без покрытия		
	AP6510	AC30C	AC90C	AP6010	ACE6	T15
CCGT						
CCGT 060202FL-FS					•	
060202FR-FS					•	
060204FL-FS					•	
060204FR-FS					•	
CCGT 09T302FL-FS					•	
09T302FR-FS					•	
09T304FL-FS					•	
09T304FR-FS					•	
09T308FL-FS					•	
09T308FR-FS					•	
CCGT 0602003FL-U					•	
0602003FR-U					•	
060201EL-U					•	
060201ER-U					•	
060201FL-U				•	•	
060201FR-U				•	•	
060202EL-U	•			•	•	
060202ER-U				•	•	
060202FL-U	•			•	•	
060202FR-U				•	•	
CCGT 09T3003FL-U					•	
09T3003FR-U					•	
09T301EL-U					•	
09T301ER-U					•	
09T301FL-U					•	
09T301FR-U				•	•	
09T302ER-U				•	•	
09T302FL-U					•	
09T302FR-U				•	•	
09T304ER-U				•		
CCGT 060202FN-Z				•		
060204FN-Z				•		
CCGT 09T302FN-Z				•		
09T304FN-Z				•		
CCGT 060201EN	•			•	•	
060202EN	•			•	•	
060204EN	•		•	•	•	
CCGT 09T301EN	•			•	•	
09T302EN	•			•	•	
09T304EN	•			•	•	
		P	•	•	•	
		M	•	•	•	
		K		•	•	
		N				
		S				
		H				

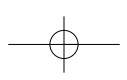



Wendeschneidplatten
Indexable inserts
Сменные пластины



CERMET

1

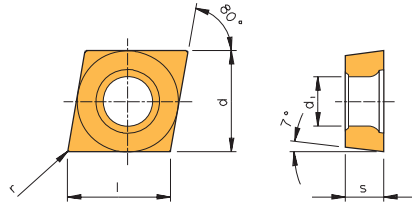
CC..



	l	d	s	d ₁
CC..06...	6,40	6,350	2,38	2,8
CC..09...	9,70	9,525	3,97	4,4
CC..12...	12,90	12,700	4,76	5,5

Bezeichnung Designation Обозначение	Sorten / Grades / Сплав					
	beschichtet / coated / с покрытием			unbeschichtet / uncoated / без покрытия		
	AP6510	AC30C	AC90C	AP6010	ACE6	T15
CCMT						
 CCMT 060202EN-AQ	●			●	●	
060204EN-AQ	●			●	●	
CCMT 09T302EN-AQ	●		●	●	●	
09T304EN-AQ	●		●	●	●	
09T308EN-AQ	●			●	●	
 CCMT 060202EN-PMC	●			●		
060204EN-PMC	●			●		
CCMT 09T302EN-PMC	●			●		
09T304EN-PMC	●			●		
CCMT 120404EN-PMC	●			●		
120408EN-PMC	●			●		
120412EN-PMC	●			●		
			●	●	●	
			●	○	●	
					○	

CD..

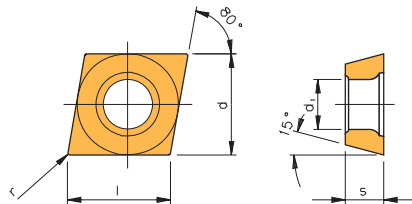

	l	d	s	d ₁
CD..04...	4,03	3,97	1,0	2,1

Achtung: Bezeichnung entspricht nicht der ISO-Norm
Attention: Designation does not correspond to ISO-designation
Внимание: Данное обозначение не соответствует обозначению по ISO

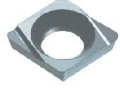
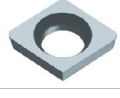
Bezeichnung Designation Обозначение	Sorten / Grades / Сплав					
	beschichtet / coated / с покрытием			unbeschichtet / uncoated / без покрытия		
	AP6510	AC30C	AC90C	AP6010	ACE6	T15
CDGT						
 CDGT 040101FL					●	
040101FR					●	
040102FL					●	
040102FR					●	
040104FL					●	
040104FR					●	
CDGW						
 CDGW 040101EN					●	
040102EN					●	
			●	●	●	
			●	○	●	
					○	



Wendeschneidplatten
Indexable inserts
Сменные пластины

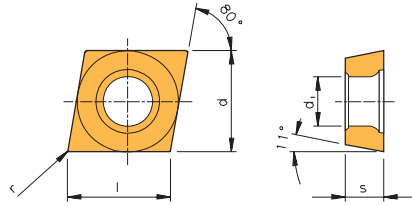

CERMET

CP..

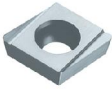

	l	d	s	d ₁
CP..05...	5,6	5,56	1,98	2,5

1

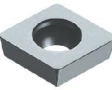
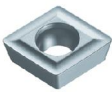
Bezeichnung Designation Обозначение	Sorten / Grades / Сплав					
	beschichtet / coated / с покрытием			unbeschichtet / uncoated / без покрытия		
	AP6510	AC30C	AC90C	AP6010	ACE6	T15
 CPET 05T101FL 05T101FR 05T102FL 05T102FR					•	
 CPGT 05T101EN 05T102EN 05T104EN					•	
 CPGW 05T101EN 05T102EN 05T104EN					•	
 CPMT 05T102EN 05T104EN					•	
					•	
					•	
					○	

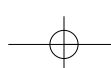



Wendeschneidplatten
Indexable inserts
Сменные пластины

CERMET

DC..

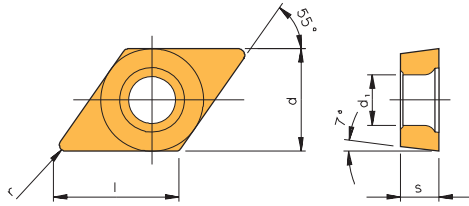

	l	d	s	d ₁
DC.. 07...	7,70	6,350	2,38	2,8
DC.. 11...	11,60	9,525	3,97	4,4

1

Bezeichnung Designation Обозначение	Sorten / Grades / Сплав					
	beschichtet / coated / с покрытием			unbeschichtet / uncoated / без покрытия		
	AP6510	AC30C	AC90C	AP6010	ACE6	T15
DCGT						
DCGT 070202FL-FS					●	
070202FR-FS					●	
070204FL-FS					●	
070204FR-FS					●	
DCGT 11T302FL-FS					●	
11T302FR-FS					●	
11T304FL-FS					●	
11T304FR-FS					●	
11T308FL-FS					●	
11T308FR-FS					●	
DCGT 0702003FL-U					●	
0702003FR-U					●	
070201FL-U	●			●	●	
070201FR-U	●			●	●	
070202EL-U	●			●	●	
070202ER-U	●			●	●	
070202FL-U	●			●	●	
070202FR-U	●			●	●	
070204EL-U	●			●	●	
070204ER-U	●			●	●	
DCGT 11T3003FL-U					●	
11T3003FR-U					●	
11T301EL-U					●	
11T301ER-U					●	
11T301FL-U					●	
11T301FR-U					●	
11T302EL-U	●			●	●	
11T302ER-U	●			●	●	
11T302FL-U	●			●	●	
11T302FR-U	●			●	●	
11T304EL-U	●			●	●	
11T304ER-U	●			●	●	
DCGT 070202FN-Z	●			●	●	
070204FN-Z	●			●	●	
DCGT 11T302EN-Z			●			
11T302FN-Z	●			●	●	
11T304FN-Z	●			●	●	
DCGT 070201EN				●	●	
070202EN	●			●	●	
070204EN	●			●	●	
DCGT 11T301EN				●	●	
11T302EN	●		●	●	●	
11T304EN	●		●	●	●	
				●	●	
				○	○	



Wendeschneidplatten
Indexable inserts
Сменные пластины

CERMET

DC..

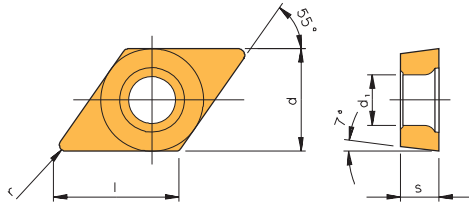

	l	d	s	d ₁
DC..07...	7,70	6,350	2,38	2,8
DC..11...	11,60	9,525	3,97	4,4

1

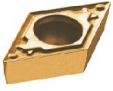
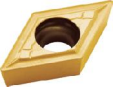
Bezeichnung Designation Обозначение	Sorten / Grades / Сплав					
	beschichtet / coated / с покрытием			unbeschichtet / uncoated / без покрытия		
	AP6510	AC30C	AC90C	AP6010	ACE6	T15
DCMT						
 DCMT 070202EN-AQ	•			•	•	
070204EN-AQ	•			•	•	
070208EN-AQ	•			•	•	
DCMT 11T302EN-AQ	•		•	•	•	
11T304EN-AQ	•		•	•	•	
11T308EN-AQ	•			•		
 DCMT 070202EN-PMC	•			•		
070204EN-PMC	•			•		
070208EN-PMC	•			•		
DCMT 11T302EN-PMC	•			•		
11T304EN-PMC	•			•		
11T308EN-PMC	•			•		
	P	•		•	•	
	M	•		○	•	
	K		•		○	
	N					
	S					
	H					

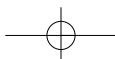



Wendeschneidplatten
Indexable inserts
Сменные пластины

CERMET

1

KC..

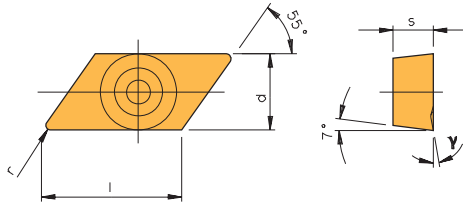

	l	d	s	γ
KC..11...	11,6	6,35	3,18	10°

Bezeichnung Designation Обозначение	Sorten / Grades / Сплав					
	beschichtet / coated / с покрытием			unbeschichtet / uncoated / без покрытия		
	AP6510	AC30C	AC90C	AP6010	ACE6	T15
KCGX  KCGX 110301FL-S 110302FL-S 110302FR-S 110304FL-S 110304FR-S						• • • • •
P						•
M						•
K						•
N						
S						
H						

SC..

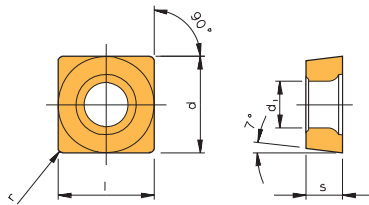

	l	d	s	d ₁
SC..09...	9,525	9,525	3,97	4,4

Bezeichnung Designation Обозначение	Sorten / Grades / Сплав					
	beschichtet / coated / с покрытием			unbeschichtet / uncoated / без покрытия		
	AP6510	AC30C	AC90C	AP6010	ACE6	T15
SCMT  SCMT 09T304EN-AQ 09T308EN-AQ					• •	
P					•	
M					•	
K					○	
N						
S						
H						



Wendeschneidplatten
Indexable inserts
Сменные пластины

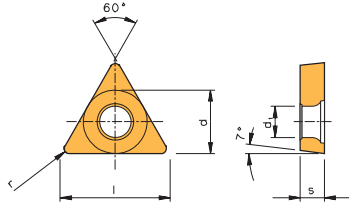

CERMET

TC..



	l	d	s	d ₁
TC..09...	9,6	5,560	2,38	2,5
TC..11...	11,0	6,350	2,38	2,8
TC..16...	16,5	9,525	3,97	4,4

1

Bezeichnung Designation Обозначение	Sorten / Grades / Сплав					
	beschichtet / coated / с покрытием			unbeschichtet / uncoated / без покрытия		
	AP6510	AC30C	AC90C	AP6010	ACE6	T15
TCGT						
 TCGT 110201FL					●	
110201FR					●	
110202FL					●	
110202FR					●	
110204FL					●	
110204FR					●	
TCMT						
 TCMT 090202EN-AQ					●	
090204EN-AQ					●	
TCMT 110202EN-AQ					●	
110204EN-AQ				●	●	
110208EN-AQ				●	●	
TCMT 16T304EN-AQ					●	
	P			●	●	
	M			○	●	
	K				○	
	N					
	S					
	H					



Wendeschneidplatten Indexable inserts Сменные пластины

CERMET

1

TP..

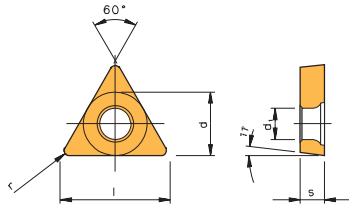

	l	d	s	d ₁
TP..09...	9,6	5,560	2,38	2,8
TP..11...	11,0	6,350	3,18	3,3
TP..16...	16,5	9,525	3,18	4,4

Bezeichnung Designation Обозначение	Sorten / Grades / Сплав					
	beschichtet / coated / с покрытием			unbeschichtet / uncoated / без покрытия		
	AP6510	AC30C	AC90C	AP6010	ACE6	T15
TPMT 090202EN-AQ	●			●		
090204EN-AQ	●			●		
TPMT 110302EN-AQ	●			●		
110304EN-AQ	●			●		
110308EN-AQ	●			●		
TPMT 160304EN-AQ	●			●	●	

VB..

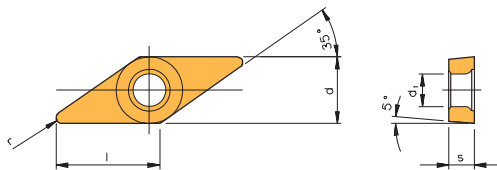

	l	d	s	d ₁
VB..11...	11,1	6,350	3,18	2,8
VB..16...	16,6	9,525	4,76	4,4

Bezeichnung Designation Обозначение	Sorten / Grades / Сплав					
	beschichtet / coated / с покрытием			unbeschichtet / uncoated / без покрытия		
	AP6510	AC30C	AC90C	AP6010	ACE6	T15
VBMT 110304EN-AQ	●			●	●	
110308EN-AQ	●			●	●	
VBMT 160404EN-AQ	●			●	●	
160408EN-AQ	●			●	●	
160412EN-AQ	●			●	●	



Wendeschneidplatten
Indexable inserts
Сменные пластины

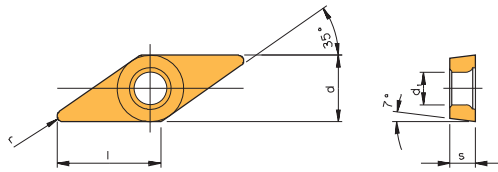

CERMET

VC..



	l	d	s	d ₁
VC. 07...	6,921	3,970	2,38	2,2
VC. 11...	11,100	6,350	3,18	2,8
VC. 16...	16,600	9,525	4,76	4,4

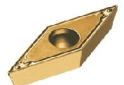

Bezeichnung Designation Обозначение	Sorten / Grades / Сплав					
	beschichtet / coated / с покрытием			unbeschichtet / uncoated / без покрытия		
	AP6510	AC30C	AC90C	AP6010	ACE6	T15
VCGT						
 VCGT 110302FL-Y					•	
110302FR-Y					•	
110304FL-Y					•	
110304FR-Y					•	
VCGT 160404FL-Y					•	
160404FR-Y					•	
VCGT 110301FN-Z					•	
110302FN-Z					•	
110304FN-Z					•	
VCGT 070200FL					•	
070200FR					•	
070201FL					•	
070201FR					•	
070202FL					•	
070202FR					•	
VCGT 070202EN					•	
070204EN					•	
VCGW						
 VCGW 070200EL					•	
070200ER					•	
070201EN					•	
070202EN					•	
VCMT						
 VCMT 110304EN-AQ					•	
VCMT 160404EN-AQ			•		•	
160408EN-AQ			•		•	
	P		•		•	
	M		•		•	
	K				○	
	N					
	S					
	H					

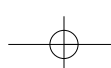



Wendeschneidplatten
Indexable inserts
Сменные пластины

CERMET

WC..

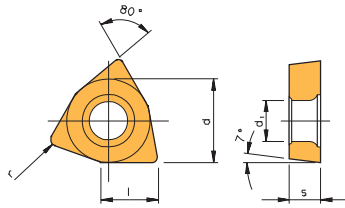

	l	d	s	d ₁
WC.. 02...	2,7	3,97	1,59	2,2

1

Bezeichnung Designation Обозначение	Sorten / Grades / Сплав					
	beschichtet / coated / с покрытием			unbeschichtet / uncoated / без покрытия		
	AP6510	AC30C	AC90C	AP6010	ACE6	T15
WCGT						
WCGT 020101EN					•	
WCGT 020102EN					•	
WCGT 020104EN					•	
WCGT 020101FL						
WCGT 020101FR					•	
WCGT 020102FL					•	
WCGT 020102FR					•	
WCGT 020104FL					•	
WCGT 020104FR					•	
WCGW						
WCGW 020101EN					•	
WCGW 020102EN					•	
WCGW 020104EN					•	
WCMT						
WCMT 020102EN					•	
WCMT 020104EN					•	
					•	
					•	
					○	

Gewindedrehen Thread turning Нарезание резьбы

1





Wendeschneidplatten - Ausführung Indexable inserts - Type Типы сменных платин

1

Standardausführung

Wendeschneidplatte für alle Gewindeprofile. Gewindedrehen bis fast an die Schulter, da die Spitze des Profils der Wendeschneidplatte so nah wie möglich an der theoretischen Spitze des Rohlingdreiecks liegt.

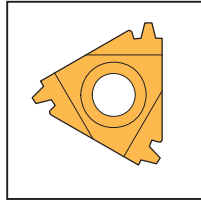

Standard geometry

Threading inserts for all thread profiles. The thread profile has been produced as close as possible to the theoretical corner that the thread can be produced as close as possible to the workpiece shoulder.

Стандартная геометрия

Геометрия пластин для нарезания резьбы всех профилей. Формообразующий профиль выполнен максимально близко к теоретическому для получения идеального профиля на детали.

V - Ausführung

Vertikal stehende Wendeschneidplatte für die Bearbeitung großer Profile, bei Steigungen von 11/16 mm und die Außenbearbeitung hinterm Bund.

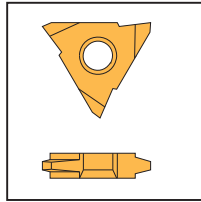

V - geometry

Vertical-threading inserts for machining large profiles and pitches from 11/16 mm. Also for threading up to the shoulders.

Геометрия V

Устанавливаемая вертикально пластина. Предназначена для обработки резьбы с крупным профилем и шагом 6 - 10 мм.

Mini - 3 - Ausführung

Für die Innenbearbeitung von kleinen Durchmessern ab 9,3 mm.

3 Schneidkanten

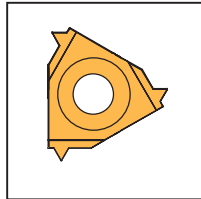

Mini - 3 - geometry

Internal threading of parts from diameter 9,3 mm.

3 cutting edges

Геометрия Mini 3

Нарезание резьбы на деталях начиная с диаметра 9,3 мм

3 режущие кромки

Mini - 2 - Ausführung

Für die Innenbearbeitung von kleinen Durchmessern ab 7,3 mm.

2 Schneidkanten

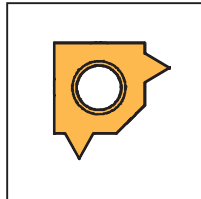

Mini - 2 - geometry

Internal threading of parts from diameter 7,3 mm.

2 cutting edges

Геометрия Mini 2

Нарезание резьбы на деталях начиная с диаметра 7,3 мм

2 режущие кромки



Sorten
Grade
Сплавы

Hartmetall beschichtet / Carbide grade coated / Твёрдые сплавы с покрытием

AL100 HC - P10, HC - M10, HC - K10, HC - N10, HC - S10, HC - H10
TiAlN-beschichtete Hartmetallsorte zur Bearbeitung von Stahlwerkstoffen, rostfreiem Stahl, Gusswerkstoffen und exotischen Materialien wie Hastelloy, Waspaloy und Inconel. Auch für die Hartzerspannung geeignet.
TiAlN-coated carbide grade for machining steel, stainless steel, cast materials and exotic materials such as Hastelloy, Waspaloy and Inconel. Grade can also be used for hard-machining.
Твёрдый сплав с TiAlN покрытием для обработки стали, нержавеющей стали, литья и экзотических материалов, таких как никель-молибденовые. Может быть использован для тяжелой обработки.

AM15C HC - P15, HC - M15, HC - K10, HC - N15, HC - H15
TiN-beschichtete Feinkorn-Hartmetallsorte mit sehr hoher Zähigkeit. Bearbeitung von Stahl, rostfreiem Stahl, Nickelbasislegierungen, Aluminium und Grauguss. Besonders geeignet für exotische Werkstoffe und säurebeständige Stähle.
TiN-coated submicron grade with high toughness. Machining steel, stainless steel, nickelbased alloys, aluminium and cast iron. Specially suitable for exotic materials and acid-resistant materials.
Твёрдый сплав с TiAlN покрытием высокой прочности. Обработка стали, нержавеющей стали, никелевых сплавов, алюминия и стального литья. Специально для обработки экзотических и кислотостойких материалов.

AM7C HC - M20, HC - N15
Mehrlagig TiN-beschichtete Hartmetallsorte mit sehr hoher Verschleißfestigkeit für die Bearbeitung von rostfreien Stählen mit ausgezeichnetem Standzeitverhalten. Auf Grund hoher Kantenstabilität geeignet für unterbrochene Schnitte.
Multilayer TiN-coated carbide grade with high wear-resistance for machining stainless steel. Excellent tool-life can be achieved. Also suitable for interrupted cuts due to the cutting edge stability.
Сплав с многослойным TiN покрытием с высокой износостойкостью для обработки нержавеющей стали. Обладает отличной износостойкостью. Так же применяется при прерывистом резании благодаря высокой стабильности режущей кромки.

Hartmetall unbeschichtet / Carbide grade uncoated / Твёрдые сплавы без покрытия

AK20 HW - K10, HW - N10, HW - S15
Bearbeitung von NE-Metallen und Grauguss bei kleinen Schnittgeschwindigkeiten. Außerdem geeignet für hochwärmfeste Werkstoffe. Gute Kantenschärfe.
Machining of non-ferrous materials and grey cast iron at normal cutting speeds. Also suitable for heat-resistant materials. Good cutting edge stability.
Обработка цветных металлов, сплавов и серого чугуна на средних скоростях резания. Применяется для обработки жаропрочных материалов. Хорошая стабильность режущей кромки.

AP30 HW - P25
Zähe Hartmetallsorte zur Bearbeitung langspanender Stahlwerkstoffe (Stahl, Stahlguss) bei mittleren Schnittgeschwindigkeiten. Gute Kantenschärfe.
Tough carbide for machining long chipping steel-materials (steel, cast steel) at medium cutting speeds. Good cutting edges.
Прочный сплав для обработки стальных материалов (сталь, стальное литьё) сдающих сливную стружку. Хорошая стабильность режущей кромки.

HSS-Schneidstoffe / HSS-material / HSS - материалы

HSS-TiN TiN-beschichteter Schnellarbeitsstahl. Bearbeitung bei sehr kleinen Schnittgeschwindigkeiten (z.B. bei konventionellen Drehmaschinen), von Teilen mit kleinen Durchmessern und Profilen mit sehr hoher Genauigkeitsanforderung. Hervorragend geeignet zum Gewindedrehen von Stahl und Buntmetallen auch bei unterbrochenem Schnitt.
TiN coated HSS-grade. Machining at very low cutting speeds (e.g. manual turning lathes), parts with very small diameters and profiles where high accuracy is required. Specially suitable for machining steel, stainless steel and non-ferrous materials even at interrupted cutting.
TiN покрытый HSS материал. Обработка с очень низкими скоростями резания (например: на универсальных токарных станках),

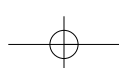



ISO - Anwendungsbereich
ISO - application area
ISO - Область применения

Gewindedrehen
Thread turning
Нарезание резьбы

1

ISO	Hartmetall beschichtet Carbide coated Твёрдые сплавы с покрытием	Hartmetall unbeschichtet Carbide uncoated Твёрдые сплавы без покрытия	Schneidstoff Cutting material Прочность / Износостойкость	Anwendung Impiego Подача / Скорость резания
P Stahl, Stahlguss, langspanender Tempergus Steel, cast steel, long chipping malleable iron	10		Zähigkeit Toughness / Прочность Verschleißbeständigkeit Wear resistance / Износостойкость	Vorschub Feed rate / Подача Schnittgeschwindigkeit Cutting speed / Скорость резания
	20			
	30			
	40			
	50			
M Rostfreier Stahl, Stahlguss, Mangan- stahl, Automatenstahl Stainless steel, cast steel, manganese steel, free cutting steel Нержавеющая сталь, стальное литье, марганцевая сталь.	10		Zähigkeit Toughness / Прочность Verschleißbeständigkeit Wear resistance / Износостойкость	Vorschub Feed rate / Подача Schnittgeschwindigkeit Cutting speed / Скорость резания
	20			
	30			
	40			
	50			
K Grauguss, Kokillenhartguss, kurzspanender Tempergus Grey cast iron, chilled hard cast iron, short chipping malleable iron	10	AL100 AM15C	Zähigkeit Toughness / Прочность Verschleißbeständigkeit Wear resistance / Износостойкость	Vorschub Feed rate / Подача Schnittgeschwindigkeit Cutting speed / Скорость резания
	20			
	30			
	40			
	50			
N Aluminium und Al - Legierungen, nichtmetallische Werkstoffe Aluminium and Al-alloys, non ferrous materials	10		Zähigkeit Toughness / Прочность Verschleißbeständigkeit Wear resistance / Износостойкость	Vorschub Feed rate / Подача Schnittgeschwindigkeit Cutting speed / Скорость резания
	20			
	30			
	40			
	50			
S Warmfeste Legierungen, Titanlegierungen High temperature resistant alloys, Titanium alloys	10		Zähigkeit Toughness / Прочность Verschleißbeständigkeit Wear resistance / Износостойкость	Vorschub Feed rate / Подача Schnittgeschwindigkeit Cutting speed / Скорость резания
	20			
	30	AK20		
	40			
	50			
H Gehärteter Stahl, Hartguss	10	AL100 AM15C	Zähigkeit Toughness / Прочность Verschleißbeständigkeit Wear resistance / Износостойкость	Vorschub Feed rate / Подача Schnittgeschwindigkeit Cutting speed / Скорость резания
	20			
	30			
	40			
	50			

Hauptanwendungsbereich / Main application area / Область первичного применения

Nebenanwendungsbereich / Secondary application area / Область вторичного применения

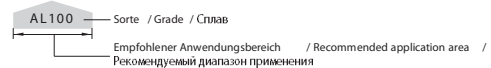



Teilprofil
Partial profile
Неполный профиль

60°

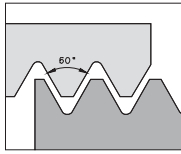

Außengewinde / External threading / Наружная резьба

Ausführung
Type
Тип
Стандарт

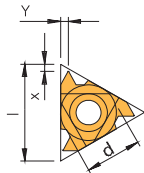

Rechte Ausführung abgebildet
Right-hand execution shown
Показано правостороннее исполнение

Steigung pitch Шаг [mm]	[G/in] (ниток/дюйм)	Bezeichnung Designation Обозначение	d	x	y	AL 100		AM15C		AM7C		AK20		AP30		HSS-TiN		Klemmhalter Toolholder Державка
						R	L	R	L	R	L	R	L	R	L	R	L	
0,50 - 1,5	48 - 16	11E R/L-T-A60	6,35	0,8	0,9	*	*	*	*	*	*	*	*	*	*	*	*	NL 8-2 R/L
0,50 - 1,5	48 - 16	16E R/L-T-A60	9,52	0,8	0,9	*	*	*	*	*	*	*	*	*	*	*	*	AL..-3 R/L
0,50 - 3,0	48 - 8	16E R/L-T-AG60	9,52	1,2	1,7	*	*	*	*	*	*	*	*	*	*	*	*	
0,50 - 3,0	48 - 8	16E R-TG-AG60	9,52	1,2	1,7	*	*	*	*	*	*	*	*	*	*	*	*	
1,75 - 3,0	14 - 8	16E R/L-T-G60	9,52	1,2	1,7	*	*	*	*	*	*	*	*	*	*	*	*	
1,75 - 3,0	14 - 8	16E R-TG-G60	9,52	1,2	1,7	*	*	*	*	*	*	*	*	*	*	*	*	
						P		○									●	
						M		●	●	●							○	
						K		○		○		●						
						N						●						
						S		○										
						H												

... -T-... = geschliffene Ausführung / ground chipbreaker / шлифованная
 ... -TG-... = gesinterte Ausführung / sintered chipbreaker / спеченная

Ausführung
Type
Тип
V

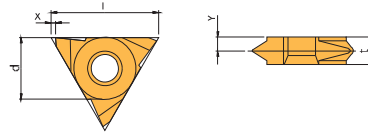

Rechte Ausführung abgebildet
Right-hand execution shown
Показано правостороннее исполнение

Steigung pitch Шаг [mm]	[G/in] (ниток/дюйм)	Bezeichnung Designation Обозначение	d	x	y	t	AL 100		AM15C		AM7C		AK20		AP30		HSS-TiN		Klemmhalter Toolholder Державка
							R	L	R	L	R	L	R	L	R	L	R	L	
11 V	0,50 - 1,5	48 - 16	11VE R/L-T-A60	6,35	0,69	2,3	3,2	*	*	*	*	*	*	*	*	*	*	*	NL..- 2V R/L
16 V	0,50 - 1,5	48 - 16	16VE R/L-T-A60	9,52	1,10	2,7	3,6	*	*	*	*	*	*	*	*	*	*	*	NL..-3V R/L
	0,50 - 3,0	48 - 8	16VE R/L-T-AG60	9,52	1,10	1,9	3,6	*	*	*	*	*	*	*	*	*	*	*	
	1,75 - 3,0	14 - 8	16VE R/L-T-G60	9,52	1,10	1,9	3,6	*	*	*	*	*	*	*	*	*	*	*	
						P		●									●		
						M		●		●							○		
						K		○		○									
						N						●							
						S		○											
						H													

Hinweis: Weitere Gewindearten finden Sie in unserem Katalog "Drehen- und Gewindedrehen" ab Seite 4.1
 Information: For other thread forms please see our catalogue "Turning and Threading" from page 4.1
 Информация: Для ознакомления с полной номенклатурой инструмента для нарезания резьбы смотрите каталог «Инструмент и сменные пластины для нарезания резьбы» начиная со страницы 4.1

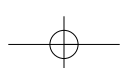



Teilprofil
Partial profile
Неполный профиль

60°

1

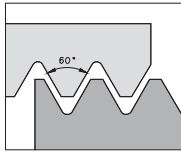

Innengewinde / Internal threading / Внутренняя резьба

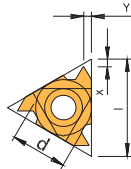

Ausführung
Type
Тип
Стандарт

Rechte Ausführung abgebildet
Right-hand execution shown
Показано правостороннее исполнение

Steigung pitch Шар [mm]	Bezeichnung Designation Обозначение	d	x	y	AL 100		AM15C		AM7C		AK20		AP30		HSS-TiN		Klemmhalter Toolholder Державка
					R	L	R	L	R	L	R	L	R	L			
11	0,50 - 1,5 48 - 16 11I R/L-T-A60	6,35	0,8	0,9	•	•	•	•	•	•	•	•	•	•	•	•	NVR...-2 R/L
0,50 - 1,5	48 - 16 11I R-TG-A60	6,35	0,8	0,9	•	•	•	•	•	•	•	•	•	•	•	•	AVR...-3 R/L
16	0,50 - 1,5 48 - 16 16I R/L-T-A60	9,52	0,8	0,9	•	•	•	•	•	•	•	•	•	•	•	•	AVR...-3 R/L
0,50 - 3,0	48 - 8 16I R/L-T-AG60	9,52	1,2	1,7	•	•	•	•	•	•	•	•	•	•	•	•	
0,50 - 3,0	48 - 8 16I R-TG-AG60	9,52	1,2	1,7	•	•	•	•	•	•	•	•	•	•	•	•	
1,75 - 3,0	14 - 8 16I R/L-T-G60	9,52	1,2	1,7	•	•	•	•	•	•	•	•	•	•	•	•	
1,75 - 3,0	14 - 8 16I R-TG-G60	9,52	1,2	1,7	•	•	•	•	•	•	•	•	•	•	•	•	
				P	•	•	•	•	•	•	•	•	•	•	•	•	
				M	•	•	•	•	•	•	•	•	•	•	•	•	
				K	•	•	•	•	•	•	•	•	•	•	•	•	
				N	•	•	•	•	•	•	•	•	•	•	•	•	
				S	•	•	•	•	•	•	•	•	•	•	•	•	
				H	•	•	•	•	•	•	•	•	•	•	•	•	

... -T-... = geschliffene Ausführung / ground chipbreaker / Шлифованная
 ... -TG-... = gesinterte Ausführung / sintered chipbreaker / спеченная

Ausführung
Type
Тип
MINI-3



Steigung pitch Шар [mm]	Bezeichnung Designation Обозначение	d	y	f	AL 100		AM15C		AM7C		AK20		AP30		HSS-TiN		Klemmhalter Toolholder Державка
					R	L	R	L	R	L	R	L	R	L			
10	0,5 - 1,5 48 - 16 6I R-T-A60	6	0,9	5,3	•	•	•	•	•	•	•	•	•	•	•	•	.NVR 1...-6.0
				P	•	•	•	•	•	•	•	•	•	•	•	•	
				M	•	•	•	•	•	•	•	•	•	•	•	•	
				K	•	•	•	•	•	•	•	•	•	•	•	•	
				N	•	•	•	•	•	•	•	•	•	•	•	•	
				S	•	•	•	•	•	•	•	•	•	•	•	•	
				H	•	•	•	•	•	•	•	•	•	•	•	•	

Ausführung
Type
Тип
MINI-2

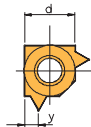

Steigung pitch Шар [mm]	Bezeichnung Designation Обозначение	d	y	f	AL 100		AM15C		AM7C		AK20		AP30		HSS-TiN		Klemmhalter Toolholder Державка
					R	L	R	L	R	L	R	L	R	L			
0,5 - 1,5	48 - 16 5LI R-T-A60	5	0,9	4,65	•	•	•	•	•	•	•	•	•	•	•	•	.NVR 10..-5 L
				P	•	•	•	•	•	•	•	•	•	•	•	•	
				M	•	•	•	•	•	•	•	•	•	•	•	•	
				K	•	•	•	•	•	•	•	•	•	•	•	•	
				N	•	•	•	•	•	•	•	•	•	•	•	•	
				S	•	•	•	•	•	•	•	•	•	•	•	•	
				H	•	•	•	•	•	•	•	•	•	•	•	•	

Hinweis: Weitere Gewindearten finden Sie in unserem Katalog "Drehen- und Gewindedrehen" ab Seite 4.1
 Information: For other thread forms please see our catalogue "Turning and Threading" from page 4.1
 Информация: Для ознакомления с полной номенклатурой инструмента для нарезания резьбы смотрите каталог «Инструмент и сменные пластины для нарезания резьбы» начиная со страницы 4.1



Teilprofil
Partial profile
Неполный профиль

55°

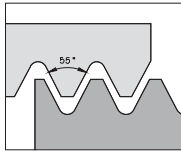

Außengewinde / External threading / Внешняя резьба

Ausführung
Type
Тип
Стандарт

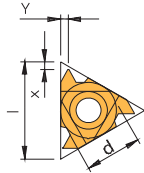

Rechte Ausführung abgebildet
Right-hand execution shown
Показано правостороннее исполнение

Steigung pitch Шар [mm]	[G/in]	Bezeichnung Designation Обозначение	d	x	y	AL 100		AM15C		AM7C		AK20		AP30		HSS-TiN		Klemmhalter Toolholder Державка
						R	L	R	L	R	L	R	L	R	L			
11	0,50 - 1,5	48 - 16 11E R/L-TA55	6,35	0,8	0,9	•	•	•	•	•	•	•	•	•	•	•	•	NL 8-2 R/L
16	0,50 - 1,5	48 - 16 16E R/L-TA55	9,52	0,8	0,9	•	•	•	•	•	•	•	•	•	•	•	•	AL.-3 R/L
	0,50 - 3,0	48 - 8 16E R/L-TAG55	9,52	1,2	1,7	•	•	•	•	•	•	•	•	•	•	•	•	
	0,50 - 3,0	48 - 8 16E R-TG-AG55	9,52	1,2	1,7	•	•	•	•	•	•	•	•	•	•	•	•	
	1,75 - 3,0	14 - 8 16E R/L-TG55	9,52	1,2	1,7	•	•	•	•	•	•	•	•	•	•	•	•	
						P	•	•	•	•	•	•	•	•	•	•	•	
						M	•	•	•	•	•	•	•	•	•	•	•	
						K	•	•	•	•	•	•	•	•	•	•	•	
						N	•	•	•	•	•	•	•	•	•	•	•	
						S	•	•	•	•	•	•	•	•	•	•	•	
						H	•	•	•	•	•	•	•	•	•	•	•	

... -T-... = geschliffene Ausführung / ground chipbreaker / Шлифованная
 ... -TG-... = gesinterte Ausführung / sintered chipbreaker / слесеная

Ausführung
Type
Тип
V

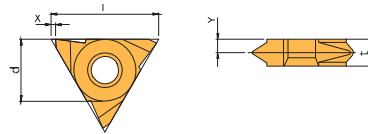

Rechte Ausführung abgebildet
Right-hand execution shown
Показано правостороннее исполнение

Steigung pitch Шар [mm]	[G/in]	Bezeichnung Designation Обозначение	d	x	y	t	AL 100		AM15C		AM7C		AK20		AP30		HSS-TiN		Klemmhalter Toolholder Державка
							R	L	R	L	R	L	R	L	R	L			
11 V	0,50 - 1,5	48 - 16 11VE R/L-TA55	6,35	0,8	2,7	3,2	•	•	•	•	•	•	•	•	•	•	•	NL.- 2V R/L	
16 V	0,50 - 1,5	48 - 16 16VE R/L-TA55	9,52	1,1	2,7	3,6	•	•	•	•	•	•	•	•	•	•	•	NL.-3V R/L	
	0,50 - 3,0	48 - 8 16VE R/L-TAG55	9,52	1,1	1,9	3,6	•	•	•	•	•	•	•	•	•	•	•		
	1,75 - 3,0	14 - 8 16VE R/L-TG55	9,52	1,1	1,9	3,6	•	•	•	•	•	•	•	•	•	•	•		
						P	•	•	•	•	•	•	•	•	•	•	•		
						M	•	•	•	•	•	•	•	•	•	•	•		
						K	•	•	•	•	•	•	•	•	•	•	•		
						N	•	•	•	•	•	•	•	•	•	•	•		
						S	•	•	•	•	•	•	•	•	•	•	•		
						H	•	•	•	•	•	•	•	•	•	•	•		

Hinweis: Weitere Gewindearten finden Sie in unserem Katalog "Drehen- und Gewindedrehen" ab Seite 4.1

Information: For other thread forms please see our catalogue "Turning and Threading" from page 4.1

Информация: Для ознакомления с полной номенклатурой инструмента для нарезания резьбы смотрите каталог «Инструмент и сменные пластины для нарезания резьбы» начиная со страницы 4.1

1



Teilprofil
Partial profile
Неполный профиль

55°

1

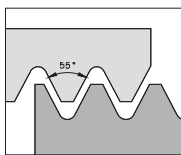

Ausführung
Type
Тип

Стандарт

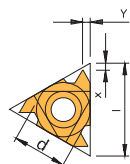

Innengewinde / Internal threading / Наружная резьба

Rechte Ausführung abgebildet
Right-hand execution shown
Показано правостороннее исполнение

Steigung pitch Шар [mm]	Bezeichnung Designation Обозначение	d	x	y	AL 100		AM15C		AM7C		AK20		AP30		HSS-TIN		Klemmhalter Toolholder Державка
					R	L	R	L	R	L	R	L	R	L			
11	48 - 16 11I R/L-T-A55	6,35	0,8	0,9	•	•	•	•	•	•	•	•	•	•	•	•	NVR...-2 R/L
16	48 - 16 16I R/L-T-A55	9,52	0,8	0,9	•	•	•	•	•	•	•	•	•	•	•	•	AVR...-3 R/L
	48 - 8 16I R/L-T-AG55	9,52	1,2	1,7	•	•	•	•	•	•	•	•	•	•	•	•	
	48 - 8 16I R-TG-AG55	9,52	1,2	1,7	•	•	•	•	•	•	•	•	•	•	•	•	
	1,75 - 3,0 14 - 8 16I R/L-T-G55	9,52	1,2	1,7	•	•	•	•	•	•	•	•	•	•	•	•	
				P	•	•	•	•	•	•	•	•	•	•	•	•	
				M	•	•	•	•	•	•	•	•	•	•	•	•	
				K	•	•	•	•	•	•	•	•	•	•	•	•	
				N	•	•	•	•	•	•	•	•	•	•	•	•	
				S	•	•	•	•	•	•	•	•	•	•	•	•	
				H	•	•	•	•	•	•	•	•	•	•	•	•	

... -T-... = geschliffene Ausführung / ground chipbreaker / шлифованная
 ... -TG-... = gesinterte Ausführung / sintered chipbreaker / спеченная

Ausführung
Type
Тип

MINI-3



Steigung pitch Шар [mm]	Bezeichnung Designation Обозначение	d	y	f	AL 100		AM15C		AM7C		AK20		AP30		HSS-TIN		Klemmhalter Toolholder Державка
					R	L	R	L	R	L	R	L	R	L			
10	48 - 16 6I R-T-A55	6	0,9	5,3	•	•	•	•	•	•	•	•	•	•	•	•	.NVR 1...-6.0
				P	•	•	•	•	•	•	•	•	•	•	•	•	
				M	•	•	•	•	•	•	•	•	•	•	•	•	
				K	•	•	•	•	•	•	•	•	•	•	•	•	
				N	•	•	•	•	•	•	•	•	•	•	•	•	
				S	•	•	•	•	•	•	•	•	•	•	•	•	
				H	•	•	•	•	•	•	•	•	•	•	•	•	

Ausführung
Type
Esecuzione

MINI-2

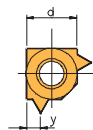

Steigung pitch Шар [mm]	Bezeichnung Designation Обозначение	d	y	f	AL 100		AM15C		AM7C		AK20		AP30		HSS-TIN		Klemmhalter Toolholder Державка
					R	L	R	L	R	L	R	L	R	L			
0,5 - 1,5	48 - 16 5LI R-T-A55	5	0,9	4,65	•	•	•	•	•	•	•	•	•	•	•	•	.NVR 10...-5L
				P	•	•	•	•	•	•	•	•	•	•	•	•	
				M	•	•	•	•	•	•	•	•	•	•	•	•	
				K	•	•	•	•	•	•	•	•	•	•	•	•	
				N	•	•	•	•	•	•	•	•	•	•	•	•	
				S	•	•	•	•	•	•	•	•	•	•	•	•	
				H	•	•	•	•	•	•	•	•	•	•	•	•	

Hinweis: Weitere Gewindearten finden Sie in unserem Katalog "Drehen- und Gewindedrehen" ab Seite 4.1
 Information: For other thread forms please see our catalogue "Turning and Threading" from page 4.1
 Информация: Для ознакомления с полной номенклатурой инструмента для нарезания резьбы смотрите каталог «Инструмент и сменные пластины для нарезания резьбы» начиная со страницы 4.1



Metrisch
Metric
Метрическая

ISO

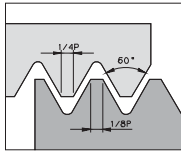

Außengewinde / External threading / Внутренняя резьба

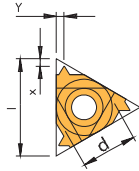

Ausführung
Type
Тип

Стандарт

Rechte Ausführung abgebildet
Right-hand execution shown
Показано правостороннее исполнение

1

Steigung pitch Шаг [mm]	Bezeichnung Designation Обозначение	d	x	y	AL 100		AM15C		AM7C		AK20		AP30		HSS-TIN		Klemmhalter Toolholder Державка
					R	L	R	L	R	L	R	L	R	L			
11	11E R/L-V-ISO 0,35	6,35	0,8	0,4	*	*	*	*	*	*	*	*	*	*	*		NL 8-2 R/L
	11E R/L-V-ISO 0,40	6,35	0,7	0,4	*	*	*	*	*	*	*	*	*	*	*		
	0,45	11E R/L-V-ISO 0,45	6,35	0,7	0,4	*	*	*	*	*	*	*	*	*	*		
	0,50	11E R/L-V-ISO 0,50	6,35	0,6	0,4	*	*	*	*	*	*	*	*	*	*		
	0,60	11E R/L-V-ISO 0,60	6,35	0,6	0,6	*	*	*	*	*	*	*	*	*	*		
	0,70	11E R/L-V-ISO 0,70	6,35	0,6	0,6	*	*	*	*	*	*	*	*	*	*		
	0,75	11E R/L-V-ISO 0,75	6,35	0,6	0,6	*	*	*	*	*	*	*	*	*	*		
	0,80	11E R/L-V-ISO 0,80	6,35	0,6	0,6	*	*	*	*	*	*	*	*	*	*		
	1,00	11E R/L-V-ISO 1,00	6,35	0,7	0,7	*	*	*	*	*	*	*	*	*	*		
	1,25	11E R/L-V-ISO 1,25	6,35	0,8	0,9	*	*	*	*	*	*	*	*	*	*		
	1,50	11E R/L-V-ISO 1,50	6,35	0,8	1,0	*	*	*	*	*	*	*	*	*	*		
1,75	11E R/L-V-ISO 1,75	6,35	0,8	1,1	*	*	*	*	*	*	*	*	*	*			
16	16E R/L-V-ISO 0,35	9,52	0,8	0,4	*	*	*	*	*	*	*	*	*	*	*		AL..-3 R/L
	0,40	16E R/L-V-ISO 0,40	9,52	0,7	0,4	*	*	*	*	*	*	*	*	*	*		
	0,45	16E R/L-V-ISO 0,45	9,52	0,7	0,4	*	*	*	*	*	*	*	*	*	*		
	0,50	16E R/L-V-ISO 0,50	9,52	0,6	0,4	*	*	*	*	*	*	*	*	*	*		
	0,60	16E R/L-V-ISO 0,60	9,52	0,6	0,6	*	*	*	*	*	*	*	*	*	*		
	0,70	16E R/L-V-ISO 0,70	9,52	0,6	0,6	*	*	*	*	*	*	*	*	*	*		
	0,75	16E R/L-V-ISO 0,75	9,52	0,6	0,6	*	*	*	*	*	*	*	*	*	*		
	0,80	16E R/L-V-ISO 0,80	9,52	0,6	0,6	*	*	*	*	*	*	*	*	*	*		
	1,00	16E R/L-V-ISO 1,00	9,52	0,7	0,7	*	*	*	*	*	*	*	*	*	*		
	1,00	16E R-VG-ISO 1,00	9,52	0,7	0,7	*	*	*	*	*	*	*	*	*	*		
	1,25	16E R/L-V-ISO 1,25	9,52	0,8	0,9	*	*	*	*	*	*	*	*	*	*		
	1,25	16E R-VG-ISO 1,25	9,52	0,8	0,9	*	*	*	*	*	*	*	*	*	*		
	1,50	16E R/L-V-ISO 1,50	9,52	0,8	1,0	*	*	*	*	*	*	*	*	*	*		
	1,50	16E R-VG-ISO 1,50	9,52	0,8	1,0	*	*	*	*	*	*	*	*	*	*		
	1,75	16E R/L-V-ISO 1,75	9,52	0,9	1,2	*	*	*	*	*	*	*	*	*	*		
	1,75	16E R-VG-ISO 1,75	9,52	0,9	1,2	*	*	*	*	*	*	*	*	*	*		
	2,00	16E R/L-V-ISO 2,00	9,52	1,0	1,3	*	*	*	*	*	*	*	*	*	*		
2,00	16E R-VG-ISO 2,00	9,52	1,0	1,3	*	*	*	*	*	*	*	*	*	*			
2,50	16E R/L-V-ISO 2,50	9,52	1,1	1,5	*	*	*	*	*	*	*	*	*	*			
2,50	16E R-VG-ISO 2,50	9,52	1,1	1,5	*	*	*	*	*	*	*	*	*	*			
3,00	16E R/L-V-ISO 3,00	9,52	1,2	1,6	*	*	*	*	*	*	*	*	*	*			
3,00	16E R-VG-ISO 3,00	9,52	1,2	1,6	*	*	*	*	*	*	*	*	*	*			
				P	●	○											
				M	●	●	●				○						
				K	○		○			●							
				N						●							
				S	○												
				H													

... -V-... = geschliffene Ausführung / ground chipbreaker / шлифованная
 ... -VG-... = gesinterte Ausführung / sintered chipbreaker / спеченная

Hinweis: Weitere Gewindearten finden Sie in unserem Katalog "Drehen- und Gewindedrehen" ab Seite 4.1
 Information: For other thread forms please see our catalog "Turning and Threading" from page 4.1
 Информация: Для ознакомления с полной номенклатурой инструмента для нарезания резьбы смотрите каталог «Инструмент и сменные пластины для нарезания резьбы» начиная со страницы 4.1

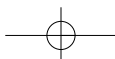



Metrisch
Metric
Метрическая

ISO

Ausführung
Type
Тип

V

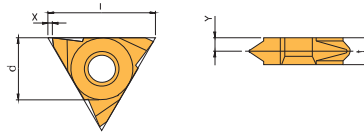

Rechte Ausführung abgebildet
Right-hand execution shown
Показано правостороннее исполнение

1

Steigung pitch Шаг [mm]	Bezeichnung Designation Обозначение	d	x	y	t	AL 100		AM15C		AM7C		AK20		AP30		HSS-TiN		Klemmhalter Toolholder Державка
						R	L	R	L	R	L	R	L	R	L			
11 V	11VE R/L-V-ISO 0,75	6,35	0,69	2,60	3,2	*	*	*	*									NL...-2V R/L
1,00	11VE R/L-V-ISO 1,00	6,35	0,69	2,50	3,2	*	*	*	*									
1,50	11VE R/L-V-ISO 1,50	6,35	0,69	2,20	3,2	*	*	*	*									
1,75	11VE R/L-V-ISO 1,75	6,35	0,69	2,10	3,2	*	*	*	*									
2,00	11VE R/L-V-ISO 2,00	6,35	0,69	1,90	3,2	*	*	*	*									
16 V	16VE R/L-V-ISO 0,50	9,52	1,10	3,00	3,6	*	*	*	*	*	*	*	*	*	*	*	*	NL...-3V R/L
0,75	16VE R/L-V-ISO 0,75	9,52	1,10	3,00	3,6	*	*	*	*	*	*	*	*	*	*	*	*	
1,00	16VE R/L-V-ISO 1,00	9,52	1,10	2,90	3,6	*	*	*	*	*	*	*	*	*	*	*	*	
1,25	16VE R/L-V-ISO 1,25	9,52	1,10	2,70	3,6	*	*	*	*	*	*	*	*	*	*	*	*	
1,50	16VE R/L-V-ISO 1,50	9,52	1,10	2,60	3,6	*	*	*	*	*	*	*	*	*	*	*	*	
1,75	16VE R/L-V-ISO 1,75	9,52	1,10	2,45	3,6	*	*	*	*	*	*	*	*	*	*	*	*	
2,00	16VE R/L-V-ISO 2,00	9,52	1,10	2,30	3,6	*	*	*	*	*	*	*	*	*	*	*	*	
2,50	16VE R/L-V-ISO 2,50	9,52	1,10	2,10	3,6	*	*	*	*	*	*	*	*	*	*	*	*	
3,00	16VE R/L-V-ISO 3,00	9,52	1,10	2,00	3,6	*	*	*	*	*	*	*	*	*	*	*	*	
				P														
				M														
				K														
				N														
				S														
				H														

Hinweis: Weitere Gewindearten finden Sie in unserem Katalog "Drehen- und Gewindedrehen" ab Seite 4.1
 Information: For other thread forms please see our catalogue "Turning and Threading" from page 4.1
 Информация: Для ознакомления с полной номенклатурой инструмента для нарезания резьбы смотрите каталог «Инструмент и сменные пластины для нарезания резьбы» начиная со страницы 4.1

1.100

Alle Abmessungen in mm
Dimensions in mm
Размеры указаны в мм

* = Ab Lager lieferbar. (Nicht als „ab Lager“ gekennzeichnete Wendeschneidplatten und weitere Typen auf Anfrage).
Ex stock, subject to prior sale (other items on request).
В наличии на складе (другие типы по заявке).

1.100



Metrisch
Metric
Метрическая

ISO

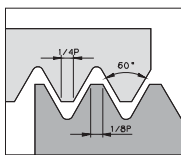

Innengewinde / Internal threading / Внутренняя резьба

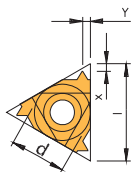

Ausführung
Type
Тип

Стандарт

Rechte Ausführung abgebildet
Right-hand execution shown
Показано правостороннее исполнение

1

Steigung pitch Шаг [mm]	Bezeichnung Designation Обозначение	d	x	y	AL 100		AM15C		AM7C		AK20		AP30		HSS-TIN		Klemmhalter Toolholder Державка
					R	L	R	L	R	L	R	L	R	L			
11	111 R/L-V-ISO 0,35	6,35	0,8	0,3	*	*	*	*	*	*	*	*	*	*	*		NVR...-2 R/L
	111 R/L-V-ISO 0,40	6,35	0,8	0,4	*	*	*	*	*	*	*	*	*	*	*		
	0,45	111 R/L-V-ISO 0,45	6,35	0,8	0,4	*	*	*	*	*	*	*	*	*	*		
	0,50	111 R/L-V-ISO 0,50	6,35	0,6	0,4	*	*	*	*	*	*	*	*	*	*		
	0,60	111 R/L-V-ISO 0,60	6,35	0,6	0,6	*	*	*	*	*	*	*	*	*	*		
	0,70	111 R/L-V-ISO 0,70	6,35	0,6	0,6	*	*	*	*	*	*	*	*	*	*		
	0,75	111 R/L-V-ISO 0,75	6,35	0,6	0,6	*	*	*	*	*	*	*	*	*	*		
	0,80	111 R/L-V-ISO 0,80	6,35	0,6	0,6	*	*	*	*	*	*	*	*	*	*		
	1,00	111 R/L-V-ISO 1,00	6,35	0,6	0,7	*	*	*	*	*	*	*	*	*	*		
	1,00	111 R-VG-ISO 1,00	6,35	0,6	0,7	*	*	*	*	*	*	*	*	*	*		
	1,25	111 R/L-V-ISO 1,25	6,35	0,8	0,9	*	*	*	*	*	*	*	*	*	*		
	1,25	111 R-VG-ISO 1,25	6,35	0,8	0,9	*	*	*	*	*	*	*	*	*	*		
	1,50	111 R/L-V-ISO 1,50	6,35	0,8	1,0	*	*	*	*	*	*	*	*	*	*		
	1,75	111 R/L-V-ISO 1,75	6,35	0,9	1,1	*	*	*	*	*	*	*	*	*	*		
2,00	111 R/L-V-ISO 2,00	6,35	0,9	1,1	*	*	*	*	*	*	*	*	*	*			
16	161 R/L-V-ISO 0,35	9,52	0,8	0,3	*	*	*	*	*	*	*	*	*	*	*	AVR...-3 R/L + NVR...-3 R/L	
	161 R/L-V-ISO 0,40	9,52	0,8	0,4	*	*	*	*	*	*	*	*	*	*	*		
	0,45	161 R/L-V-ISO 0,45	9,52	0,8	0,4	*	*	*	*	*	*	*	*	*	*		
	0,50	161 R/L-V-ISO 0,50	9,52	0,6	0,4	*	*	*	*	*	*	*	*	*	*		
	0,60	161 R/L-V-ISO 0,60	9,52	0,6	0,6	*	*	*	*	*	*	*	*	*	*		
	0,70	161 R/L-V-ISO 0,70	9,52	0,6	0,6	*	*	*	*	*	*	*	*	*	*		
	0,75	161 R/L-V-ISO 0,75	9,52	0,6	0,6	*	*	*	*	*	*	*	*	*	*		
	0,80	161 R/L-V-ISO 0,80	9,52	0,6	0,6	*	*	*	*	*	*	*	*	*	*		
	1,00	161 R/L-V-ISO 1,00	9,52	0,6	0,7	*	*	*	*	*	*	*	*	*	*		
	1,00	161 R-VG-ISO 1,00	9,52	0,6	0,7	*	*	*	*	*	*	*	*	*	*		
	1,25	161 R/L-V-ISO 1,25	9,52	0,8	0,9	*	*	*	*	*	*	*	*	*	*		
	1,50	161 R/L-V-ISO 1,50	9,52	0,8	1,0	*	*	*	*	*	*	*	*	*	*		
	1,50	161 R-VG-ISO 1,50	9,52	0,8	1,0	*	*	*	*	*	*	*	*	*	*		
	1,75	161 R/L-V-ISO 1,75	9,52	0,9	1,2	*	*	*	*	*	*	*	*	*	*		
1,75	161 R-VG-ISO 1,75	9,52	0,9	1,2	*	*	*	*	*	*	*	*	*	*			
2,00	161 R/L-V-ISO 2,00	9,52	1,0	1,3	*	*	*	*	*	*	*	*	*	*			
2,00	161 R-VG-ISO 2,00	9,52	1,0	1,3	*	*	*	*	*	*	*	*	*	*			
2,50	161 R/L-V-ISO 2,50	9,52	1,1	1,5	*	*	*	*	*	*	*	*	*	*			
2,50	161 R-VG-ISO 2,50	9,52	1,1	1,5	*	*	*	*	*	*	*	*	*	*			
3,00	161 R/L-V-ISO 3,00	9,52	1,1	1,5	*	*	*	*	*	*	*	*	*	*			
3,00	161 R-VG-ISO 3,00	9,52	1,1	1,5	*	*	*	*	*	*	*	*	*	*			
				P	●	○											
				M	●	●	●	●	○								
				K	○		○	●	●								
				N				●									
				S	○												
				H													

... - V - ... = geschliffene Ausführung / ground chipbreaker / шлифованная
 ... - VG - ... = gesinterte Ausführung / sintered chipbreaker / спеченная

Hinweis: Weitere Gewindearten finden Sie in unserem Katalog "Drehen- und Gewindedrehen" ab Seite 4.1
 Information: For other thread forms please see our catalogue "Turning and Threading" from page 4.1
 Информация: Для ознакомления с полной номенклатурой инструмента для нарезания резьбы смотрите каталог «Инструмент и сменные пластины для нарезания резьбы» начиная со страницы 4.1

1.101

Alle Abmessungen in mm
Dimensions in mm
Размеры указаны в мм

* = Ab Lager lieferbar. (Nicht als „ab Lager“ gekennzeichnete Wendeschneidplatten und weitere Typen auf Anfrage).
Ex stock, subject to prior sale (other items on request).
В наличии на складе (другие типы по заявке).

1.101

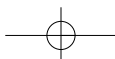



Metrisch
Metric
Метрическая

ISO

1

Ausführung
Type
Тип

MINI-3

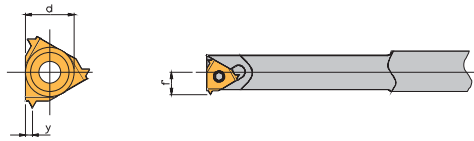

	Steigung pitch Шаг [mm]	Bezeichnung Designation Обозначение	d	y	f	AL 100	AM15C	AM7C	AK20	AP30	HSS-TiN	Klemmhalter Toolholder Державка
	0,50	6I R-V-ISO 0,50	6	0,60	4,4		•				•	.NVR 1..6.0
	0,75	6I R-V-ISO 0,75	6	0,60	4,6		•				•	
	1,00	6I R-V-ISO 1,00	6	0,70	4,7		•				•	
	1,25	6I R-V-ISO 1,25	6	0,90	4,9		•				•	
	1,50	6I R-V-ISO 1,50	6	1,00	5,0		•				•	
	1,75	6I R-V-ISO 1,75	6	1,05	5,2		•				•	
	2,00	6I R-V-ISO 2,00	6	1,05	5,3		•				•	
				P			○				●	
				M			●				○	
				K								
				N								
				S							○	
				H								

Ausführung
Type
Тип

MINI-2

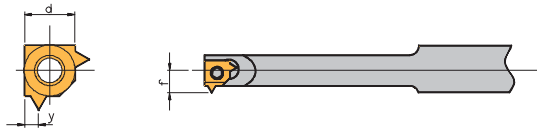

	Steigung pitch Шаг [mm]	Bezeichnung Designation Обозначение	d	y	f	AL 100	AM15C	AM7C	AK20	AP30	HSS-TiN	Klemmhalter Toolholder Державка
	0,50	5LI R-V-ISO 0,50	5	0,60	3,75		•				•	
	0,75	5LI R-V-ISO 0,75	5	0,60	3,91		•				•	
	1,00	5LI R-V-ISO 1,00	5	0,70	4,06		•				•	
	1,25	5LI R-V-ISO 1,25	5	0,90	4,21		•				•	
	1,50	5LI R-V-ISO 1,50	5	1,00	4,35		•				•	
	1,75	5LI R-V-ISO 1,75	5	1,05	4,51		•				•	
	2,00	5LI R-V-ISO 2,00	5	1,05	4,65		•				•	
				P			○				●	
				M			●				○	
				K								
				N								
				S							○	
				H								

Hinweis: Weitere Gewindearten finden Sie in unserem Katalog "Drehen- und Gewindedrehen" ab Seite 4.1
 Information: For other thread forms please see our catalogue "Turning and Threading" from page 4.1
 Информация: Для ознакомления с полной номенклатурой инструмента для нарезания резьбы смотрите каталог «Инструмент и сменные пластины для нарезания резьбы» начиная со страницы 4.1



Klemmhalter
Toolholder
Державки

Außengewinde / External threading / Filettatura esterna



Ausführung
Type
Тип **Стандарт**

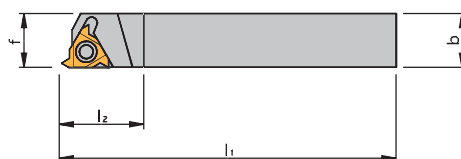

Rechte Ausführung abgebildet
Right-hand execution shown
Показано правостороннее исполнение

Halter / Holder / Державки

	Bezeichnung Designation Обозначение	$h = h_1 = b$	f	l_1	l_2
11	NL 8-2 R/L	8	11	136,4	17,5
16	NL 12-3 R/L	12	16	83,2	22,0
	AL 16-3 R/L	16	16	100,0	20,5
	AL 20-3 R/L*	20	20	128,6	30,0

* Diese Halter sind auch als Standardhalter mit zusätzlicher **Pratzenklammer** erhältlich (Bestellbezeichnung: AL... R/L -C)
This holder is also available as standard holder with additional **top clamp** (ordering code: AL... R/L -C)
Данная державка, также доступна как и стандартная державка с дополнительным **верхним прижимом**. (Код заказа AL... R/L-C)

HINWEIS:
Die Klemmhalter haben einen Neigungswinkel von 1,5°.

Diese müssen separat bestellt werden.
Klemmhalter mit der Bezeichnung „N.“ werden ohne Unterlegplatte benutzt.

INFORMATION:
The toolholders are supplied with 1,5° helix angles.

Toolholders designated with „N.“ does not contain anvil.

ИНФОРМАЦИЯ:
Державка поставляется с углом подъема резьбы 1,5°.
При другом угле подъема резьбы ознакомьтесь с информацией на стр. 4.53.
Эти подкладные пластины заказываются отдельно.
Державки исполнения «N.» поставляются без опорной пластины.

Ersatzteile / Spare parts / Комплекующие

	Klemmschraube Clamping screw Винт крепления	Schraube + Scheibe für Unterlegplatte Screw + washer for support pad Винт опорной пластины	Schlüssel Key Ключ	Unterlegplatte Support pad Опорная пластина
11	SN2T	-	KS 1751	-
16	SA3T	SY3T	KS 2510	YE3 Y13

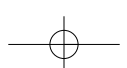



Klemmhalter
Toolholder
Державки

Außengewinde / External threading / Наружная резьба

1

Ausführung
Type
Тип **V**

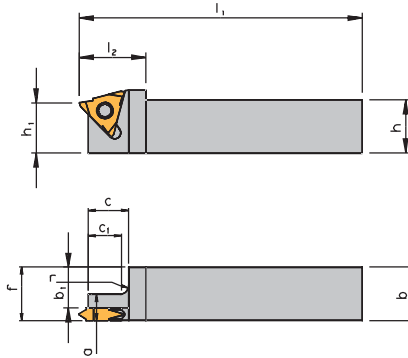



Rechte Ausführung abgebildet
Right-hand execution shown
Показано правостороннее исполнение

Halter / Holder / Державки

 Bezeichnung Designation Обозначение		$h = h_1 = b$	f	a	b_1	c	c_1	r	l_1	l_2
11 V	NL 8-2V R/L	8	10	7	4,83	12,5	11,5	1	60	14
	NL 10-2V R/L	10	10	7	6,83	12,5	11,5	1	70	14
	NL 12-2V R/L	12	12	7	8,83	14,5	11,5	3	80	14
16 V	NL 16-2V R/L	16	16	7	12,83	14,5	11,5	3	100	14
	NL 16-3V R/L	16	16	7	12,40	14,5	11,5	3	100	25
	NL 20-3V R/L	20	20	7	16,40	16,5	11,5	3	125	30

Ersatzteile / Spare parts / Комплектующие

 Klemmschraube Clamping screw Винт крепления		 Schlüssel Key Ключ	
11 V	SN2T	KS 1751	
16 V	SN3T	KS 2510	



Klemhalter
Toolholder
Державки

Innengewinde / Internal threading / Внутренняя резьба

Ausführung
Type
Тип
Стандарт

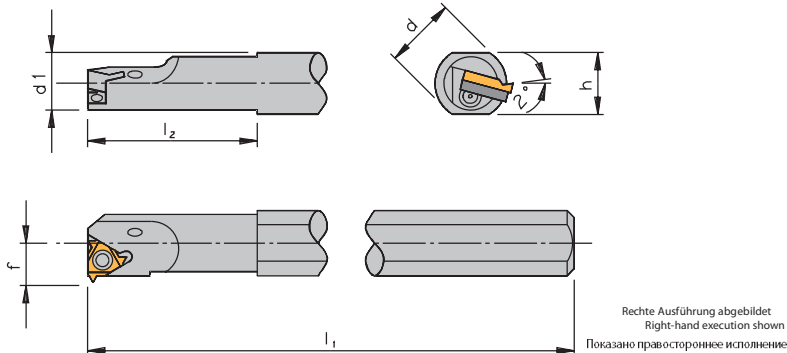

Halter / Holder / Державки

	Bezeichnung Designation Обозначение	d	d ₁	f	h	l ₁	l ₂	min. Kernloch - Ø min. bore - Ø Ø min отверстия
11	NVR 10-2 R/L	20	10,0	7,3	18,0	180	25	13
	NVR 13-2 R/L	20	13,0	8,9	18,0	180	32	16
16	NVR 13-3 R/L	20	12,7	10,3	18,0	180	32	17
	NVR 16-3 R/L	20	16,0	11,5	18,0	180	40	20
	NVR 16D-3 R/L	16	16,0	11,3	15,2	150	32	20
	AVR 20-3 R/L*	20	20,0	13,4	18,0	180	40	24

* Diese Halter sind auch als Standardhalter mit zusätzlicher **Pratzenklemmung** erhältlich (Bestellbezeichnung: AVR... R/L -C)
This holder is also available as standard holder with additional **top clamp** (ordering code: AVR ... R/L -C)
Данная державка, также доступна как и стандартная державка с дополнительным **верхним прижимом**. (Код заказа AL... R/L-C)

HINWEIS:
Die Klemhalter haben einen Neigungswinkel von 1,5°.

Diese müssen separat bestellt werden.
Klemhalter mit der Bezeichnung „N.“ werden ohne Unterlegplatte benutzt.

INFORMATION:
The toolholders are supplied with 1,5° helix angles.

Toolholders designated with „N.“ does not contain anvil.

Информация:
Державка поставляется с углом подъема резьбы 1,5°.

Эти подкладные пластины заказываются отдельно.
Державки исполнения «N.» поставляются без опорной пластины.

Ersatzteile / Spare parts / Комплекующие

	Klemmschraube Clamping screw Винт крепления	Schraube + Scheibe für Unterlegplatte Screw + washer for support pad Винт опорной пластины	Schlüssel Key Ключ	Unterlegplatte Support pad Опорная пластина R L
11	SN2T	-	KS 1751	- -
16 ^①	SA3T	SY3T	KS 2510	Y13 YE3

^① NVR 16-3 R/L erfordert Klemmschraube SN3T.

^① NVR 16-3 R/L requires clamping screw SN3T.

^① При использовании державки NVR 16-3 R/L необходимо применять винт крепления SN3T.



Klemmhalter
Toolholder
Державки

Innengewinde / Internal threading / Внутренняя резьба

1

Ausführung
Type
Тип

Стандарт

Klemmhalter mit Vollhartmetallschaft
Toolholder with solid carbide shank
Твёрдосплавная державка

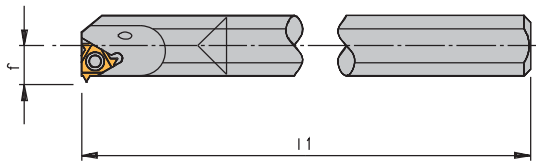
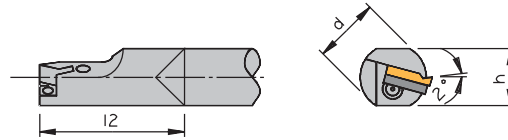

Rechte Ausführung abgebildet
Right-hand execution shown
Показано правостороннее исполнение

Halter / Holder / Державки

	Bezeichnung Designation Обозначение	d	f	h	l ₁	l ₂	min. Kernloch - Ø min. bore - Ø Ø min отверстия.
11	CNVRC 10-2 R/L	10	7,3	9,5	150	19	13
	CNVRC 12-2 R/L	12	8,3	11,7	180	25	15
16	CNVRC 16-3 R/L	16	11,5	15,6	200	27	20
	CAVRC 20-3 R/L	20	13,4	19,5	250	35	24

HINWEIS:
Die Klemmhalter haben einen Neigungswinkel von 1,5°.

INFORMATION:
The toolholders are supplied with 1,5° helix angles.

ИНФОРМАЦИЯ:
Державка поставляется с углом подъёма резьбы 1,5°. При другом угле подъёма резьбы ознакомьтесь с информацией на стр. 4.53. Эти подкладные пластины заказываются отдельно. Державки исполнения «N.» поставляются без опорной пластины.

Klemmhalter mit der Bezeichnung „N.“ werden ohne Unterlegplatte benutzt.

Toolholders designated with „N.“ does not contain anvil.

Ersatzteile / Spare parts / Комплекующие

	Klemmschraube Clamping screw Винт крепления	Schraube + Scheibe für Unterlegplatte Screw + washer for support pad Винт опорной пластины	Schlüssel Key Ключ	Unterlegplatte Support pad Опорная пластина R L
11	SN2T	-	KS 1751	- -
16 ①	SA3T	-	KS 2510	- -
16	SA3T	SY3T	KS 2510	Y13 YE3

① Ersatzteile für Halter CNVRC 16-3 R/L.

① Spare parts for holder CNVRC 16-3 R/L.

① Комплекующие для державки CNVRC 16-3 R/L.

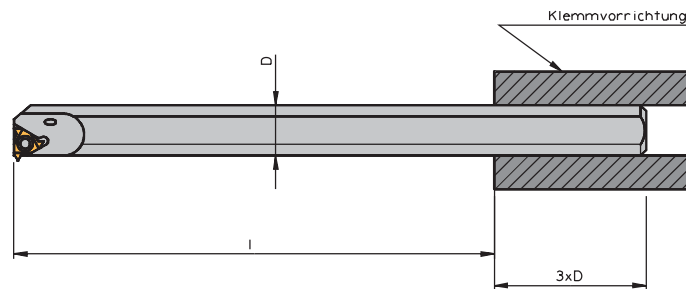

HINWEIS:
Klemmhalter mit Vollhartmetallschaft für höchste Steifigkeit beim Innengewindedrehen. Bevorzugter Einsatz bei großer Auskraglänge des Halters, mehr als 3 x Schaftdurchmesser.
Um Vibrationen zu vermeiden ist darauf zu achten, die Auskraglänge so klein wie möglich zu halten.
Die minimale Länge des Halters in der Werkzeugaufnahme sollte 3 x Schaftdurchmesser nicht unterschreiten.

INFORMATION:
Toolholders with carbide shanks should be used when extra accuracy is required or when the bar length to bar diameter ratio exceeds 3 : 1.
The overhang to bar diameter ratio should be as small as possible to eliminate the chance of vibration. The minimum length in a holding device should be 3-times the diameter of the bar shank.

Информация:
Твёрдосплавная державка используется при повышенных требованиях к точности обработки или в условиях, когда вылет державки по отношению к её диаметру превышает соотношение 3:1.
Для исключения возможности возникновения вибрации необходимо стремиться делать вылет державки минимальным. Минимальная длина зажима должна быть не меньше чем три диаметра оправки.



Klemmhalter
Toolholder
Державки

Innengewinde / Internal threading / Внутренняя резьба

Ausführung
Type
Тип **MINI-3**

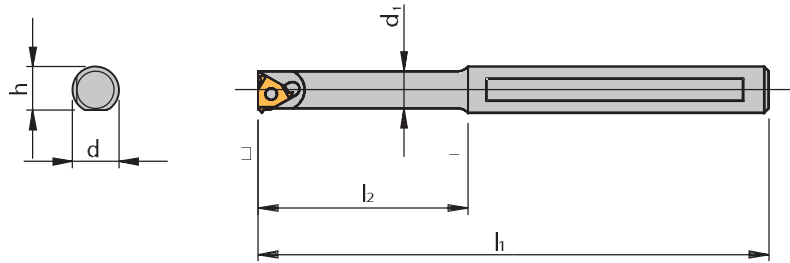

Rechte Ausführung abgebildet
Right-hand execution shown
Показано правостороннее исполнение

Halter / Holder / Державки

	Bezeichnung Designation Обозначение	d	d ₁	h	l ₁	l ₂	min. Kernloch - Ø min. bore - Ø Ø min отверстия
10	SNVR/L 12U-6,0	12	8	11,4	82	16	10
	BNVR/L 10S-6,0	10	8	9,4	89	22	10
	BNVR/L 10M-6,0	10	8	9,4	98	31	10
	BNVR/L 10L-6,0	10	8	9,4	110	43	10

HINWEIS:
Klemmhalter mit der Bezeichnung „B.“ sind mit einem Hartmetallkern zur Minimierung von Vibrationen ausgeführt.

INFORMATION:
The toolholders designated with „B.“ are supplied with a carbide center in order to minimize vibration.

ИНФОРМАЦИЯ:
Державки с обозначением «B.» снабжены твёрдосплавным сердечником для снижения возможности возникновения вибрации.

Klemmhalter verstellbar
Toolholder adjustable
Державки регулируемые

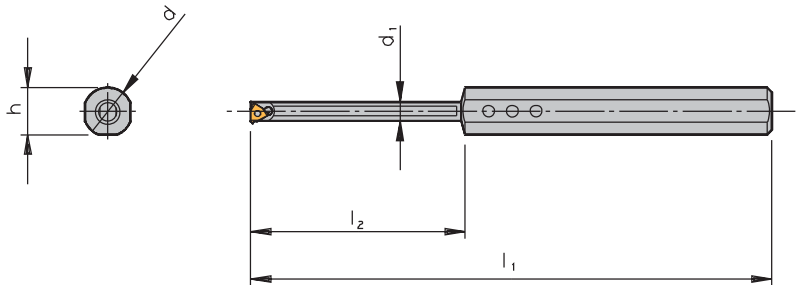

Rechte Ausführung abgebildet
Right-hand execution shown
Показано правостороннее исполнение

Halter / Holder / Державки

	Bezeichnung Hülse Designation sleeve Стержень	Bezeichnung Halter Designation holder Держатель	d	d ₁	h	l ₁	l ₂	min. Kernloch - Ø min. bore - Ø Ø min тверстия
10	SV 16-8.0	BNVR 8.0T-6.0	16	8	15,6	100	8-56	10

Ersatzteile / Spare parts / Комплекующие

	Für Halter / for holder / Per lo stelo		Für Hülse / for sleeve / Per la bussola	
	Klemmschraube Clamping screw Винт крепления	Schlüssel Key Ключ	Klemmschraube Clamping screw Винт крепления	Schlüssel Key Ключ
10	SN6MT	KS 1886	S4.0	KP 3421





Klemmhalter
Toolholder
Державки

Innengewinde / Internal threading / Внутренняя резьба

1

Ausführung
Type
Тип **MINI-2**

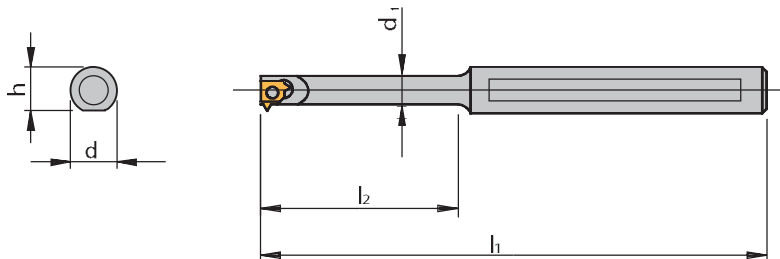

Rechte Ausführung abgebildet
Right-hand execution shown
Показано правостороннее исполнение

Halter / Holder / Державки

Bezeichnung Designation Обозначение	d	d ₁	h	l ₁	l ₂	min. Kernloch - Ø min. bore - Ø Ø min отверстия
SNVR 10U-5L	10	6,2	9,4	81	16	8
BNVR 10S-5L	10	6,2	9,4	87	22	8
BNVR 10M-5L	10	6,2	9,4	97	31	8
BNVR 10L-5L	10	6,2	9,4	109	43	8

HINWEIS:
Klemmhalter mit der Bezeichnung „B.“ sind mit einem Hartmetallkern zur Minimierung von Vibrationen ausgeführt.

INFORMATION:
The toolholders designated with „B.“ are supplied with a carbide center in order to minimize vibration.

ИНФОРМАЦИЯ:
Державки с обозначением «B.» снабжены твёрдосплавным сердечником для снижения возможности возникновения вибрации.

Klemmhalter verstellbar
Toolholder ajustable
Державки регулируемые

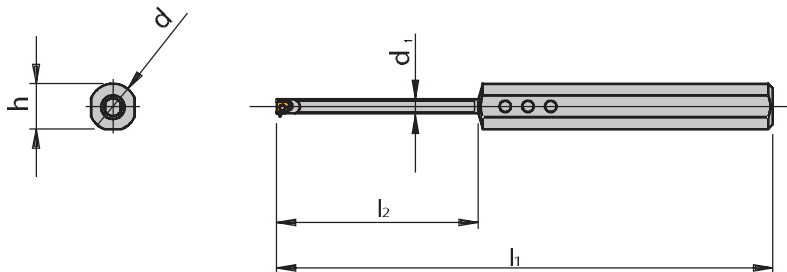

Rechte Ausführung abgebildet
Right-hand execution shown
Показано правостороннее исполнение

Halter / Holder / Державки

Bezeichnung Hülse Designation sleeve Стержень	Bezeichnung Halter Designation holder Держатель	d	d ₁	h	l ₁	l ₂	min. Kernloch - Ø min. bore - Ø min. ingresso - Ø
SV 16-6.2	BNVR 6.2T-5L	16	6,2	15,6	100	8-44	8

Ersatzteile / Spare parts / Комплектующие

Für Halter / for holder / Per lo stelo		Für Hülse / for sleeve / Per la bussola	
Klemmschraube	Schlüssel	Klemmschraube	Schlüssel
Clamping screw	Key	Clamping screw	Key
Винт крепления	Ключ	Винт крепления	Ключ
SN5LT	KS 2505	S4.0	KP 3421



Klemmhalter
Toolholder
Державки

Außen- und Innengewinde / External and internal threading / Наружная и внутренняя резьба

Ausführung **Minihalter**
Type **Miniature square**
Тип **Mini**

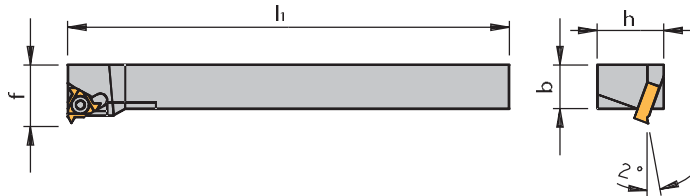

Minihalter mit Vierkantschaft
Miniature square with square shank
Мини-державка с квадратным хвостовиком

Rechte Ausführung abgebildet
Right-hand execution shown
Показано правостороннее исполнение

Halter / Holder / Державки

	Bezeichnung Designation Обозначение	b = h	f	l ₁
11	OV 8-2 R/L	8	12	100
	OV 10-2 R/L	10	14	100

Minihalter mit Zylinderschaft
Miniature square holder with cylinder shank
Мини-державка с цилиндрическим хвостовиком

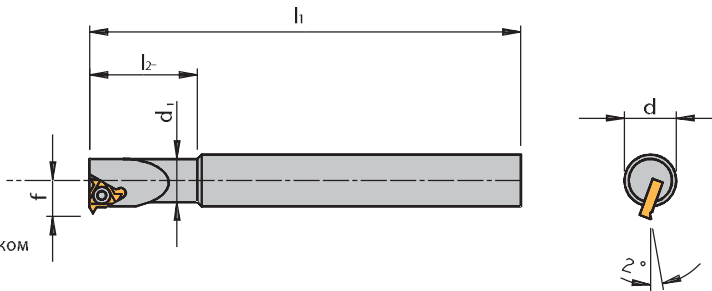

Rechte Ausführung abgebildet
Right-hand execution shown
Показано правостороннее исполнение

Halter / Holder / Державки

	Bezeichnung Designation Обозначение	d	d ₁	f ₁	l ₁	l ₂
11	OVR 12-2 R/L	12	10	7,4	100	25
	OVR 15-2 R/L	15	13	8,9	100	32

HINWEIS:
Minihalter in runder oder rechteckiger Schaftausführung sind speziell für den Einsatz auf Drehautomaten, die in der optischen und feinmechanischen Industrie ihre Anwendung finden. Die Halter können für Außen- und Innengewinde eingesetzt werden.

INFORMATION:
Miniature square and round toolholders are designated for use on automatic lathes for the optical and other precision industries. They can be used for both external and internal threading.

ИНФОРМАЦИЯ:
Мини-державки с квадратным и цилиндрическим хвостовиком применяются на токарных автоматических станках в оптической и других отраслях промышленности. Используются для нарезания как наружной, так и внутренней резьбы.

Gewinde	ER	EL	IR	IL
WSP	ER	EL	IR	IL
Minihalter	L	R	R	L

Thread	ER	EL	IR	IL
Insert	ER	EL	IR	IL
Min.square	L	R	R	L

Резьба	ER	EL	IR	IL
Пластина	ER	EL	IR	IL
Державка	L	R	R	L

E = Außen / I = Innen / R = Rechts / L = Links
Der Neigungswinkel beträgt 0,5°.

E = external / I = internal / R = right-hand / L = left-hand
The toolholders are supplied with 0,5° helix angle.

E = наружная / I = внутренняя / R = правая / L = левая
Державка поставляется с углом подъема резьбы 0,5°.

Ersatzteile / Spare parts / Комплекующие

	Klemmschraube Clamping screw Винт крепления	Schlüssel Key Ключ
11	SN2T	KS 1751



ARNO[®]
WERKZEUGE

1

Weitere Anwendungshinweise zum Gewindedrehen finden Sie in unserem Katalog "Werkzeuge und Wendeschneidplatten zum Drehen und Gewindedrehen" auf den Seiten i.15 bis i.18.

You can find more technical information in our catalogue "Tools and Inserts for Turning and Threading" on page i.15 to i.18

Более полную техническую информацию вы можете найти в каталоге «Инструмент и сменные пластины для токарной обработки и нарезания резьбы» со стр. i.15 по стр. i.18



DECO-Cut

2





Übersicht
 Program overview
 Обзор программы

Beste Präzision und Wirtschaftlichkeit!

Für verschiedenste Anwendungen auf Langdrehautomaten in unterschiedlichsten Werkstoffen.

- zweischneidige Wendeschneidplatte
- durch Y-Plattensitz mit 3-Punkt-Auflage höchste Stabilität und Wiederholgenauigkeit in der Länge und Spitzenhöhe
- aufgrund einer zentralen Klemmschraube sehr schneller Plattenwechsel möglich
- speziell für das Langdrehen entwickelte Geometrien
- Feinstkornsorten wahlweise mit Hochleistungs-PVD-Beschichtungen
- alle Aufnahmeschäfte sind präzise geschliffen.



Precision and Productivity

For all applications and all materials.

- Ground double sided inserts
- Insert seating with 3 point location gives maximum stability and repeatability accuracy for both length and height
- Single insert screw ensures rapid insert change
- Insert geometries especially developed for auto lathe turning
- Fine grain carbide with optional PVD coating for better performance
- All tool shanks are precision ground.

Точность и Производительность!

Для различного применение по всем видам материалов.

- Шлифованная двухсторонняя пластина
- Крепления пластины в трех точках обеспечивает максимальную стабильность и точность параметров после замены
- Крепление одним винтом обеспечивает быструю замену
- Мелкодисперсный твердый сплав с PVD покрытием с улучшенными эксплуатационными качествами.
- Все державки шлифованные.



Grundhalter – Drehoperationen
Tool holder
Стандартная державка

Standard-Drehhalter mit Vierkantschaft
 zum Drehen, Stechdrehen und Gewindeschneiden.

Standard tool holder with
 square shank for turning, groove & turn and threading.

Стандартные державки
 Державки с квадратным сечением для токарной обработки,
 обработки канавок и резьбонарезания.

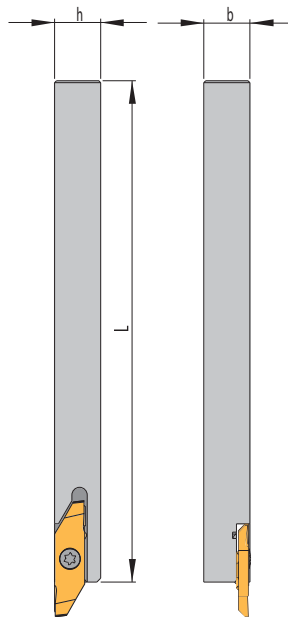

Rechte Ausführung abgebildet
 Right-hand execution shown
 Показано правостороннее исполнение



Halter / Holder / Державки

Bezeichnung Designation Обозначение	h	b	L	Wendeschneidplatte Indexable Inserts Пластины
SLAO R/L 0808 X08-115	8	8	115	L.. 08...
SLAO R/L 1010 X08-115	10	10	115	L.. 08...
SLAO R/L 1212 X08-130	12	12	130	L.. 08...
SLAO R/L 1212 X08-90	12	12	90	L.. 08...
SLAO R/L 1313 X08-130	13	13	130	L.. 08...
SLAO R/L 1616 X08-130	16	16	130	L.. 08...
SLAO R/L 1616 X08-75	16	16	75	L.. 08...
SLAO R/L 2020 X08-120	20	20	120	L.. 08...

Ersatzteile / Spare parts / Комплекующие

Bezeichnung Designation Обозначение	Schraube Screw Винт	Torxschlüssel Torx-Key Torx -Ключ
SLAO R/L 0808	AS0029	KS1111
SLAO R/L 1010 bis 2020	AS0028	KS1111

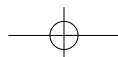



Grundhalter – Drehoperationen
Tool holder
Стандартная державка

Drehhalter mit Zylinderschaft

- zum Drehen, Stechdrehen und Gewindeschneiden
- zur Aufnahme auf Bohrstationen an Haupt- und Gegenspindel
- für linke und auch rechte Wendeschneidplatten einsetzbar

Tool holder with cylindrical shank

- For turning, groove & turn and threading
- Cylindrical shank for applying on main or counter spindle
- Suitable for both right and left-hand inserts

Стандартная державка с цилиндрическим хвостовиком

- Для точения, резьбонарезания, обработки канавок и точения
- Цилиндрический хвостовик для установки в главный или вспомогательный шпиндель.
- Используется для установки правосторонних и левосторонних пластин

2

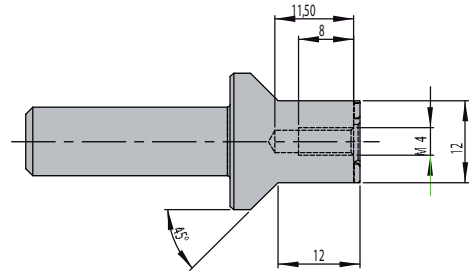
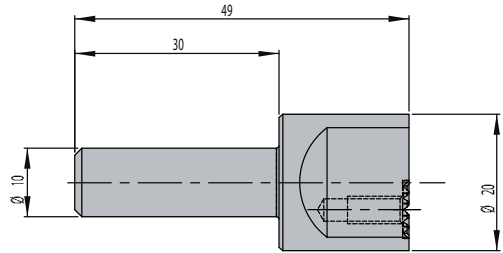
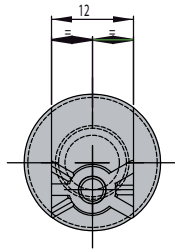
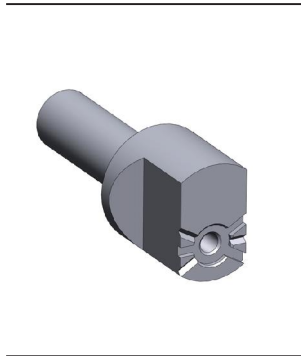

Halter / Holder / Державка

Bezeichnung Designation Обозначение	L ₁	L ₂	D	Wendeschneidplatte Indexable Inserts Пластина
SLCO N 10 X08	30	22	10	L.. 08...

Hinweis: Weitere Durchmesser auf Anfrage.
 Information: Other diameters are available on request.
 Информация: Другие диаметры державок доступны по заявке.

Ersatzteile / Spare parts / Комплекующие

Bezeichnung Designation Обозначение	Schraube Screw Винт	Torxschlüssel Torx-Key Torx-Ключ
SCLCO N 10 X08	AS0028	KS1111



Grundhalter – Abstechen
Tool holder
Специальная державка

Drehhalter mit abgesetztem Vierkantschaft

- zum Abstechen kurzer Werkstücke bei Maschinen mit Abgreifspindel
- Abstechposition nahe der Hauptspindel, daher auch bei kleinen Durchmessern stabile Werkstückspannung

Tool holder with off-set square shank

- For parting-off short work pieces on machines with sub spindle
- Part-off position near the main spindle ensures maximum component clamping also by smaller diameters.

Державка с зауженной рабочей частью

- Для отрезки коротких заготовок с использованием противощпинделя.
- Отрезка в непосредственной близости от шпинделя обеспечивает максимальную стабильность процесса, а также позволяет производить отрезку малых диаметров.

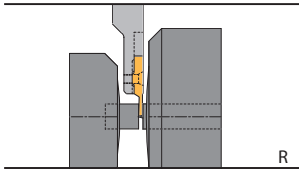

Einsatz mit Wendeschneidplatte: LAB 082085F R-L
 Illustration with Insert: LAB 082085F R-L
 На иллюстрации показана пластина: LAB 082085F R-L

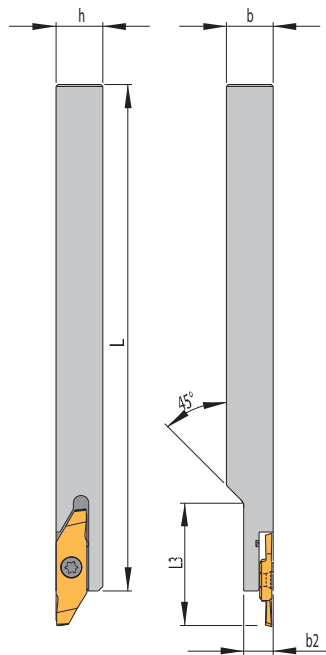

Halter / Holder / Державка

Bezeichnung Designation Обозначение	h	b	b ₂	L	L ₃	Wendeschneidplatte Indexable Inserts Пластина
SLXO R 1212 X08-130	12	12	7,5	130	30	L..08...

Ersatzteile / Spare parts / Комплекующие

Bezeichnung	Schraube	Torxschlüssel
Designation	Screw	Torx-Key
Обозначение	ВИНТ	Торх-Ключ
SCLCO N 10 X08	AS0028	KS1111



Grundhalter – Abstechen
Tool holder
Специальная державка

Schlanker Drehhalter mit versetztem Plattensitz und Vierkantschaft

- zum vereinfachten Wechsel der Wendschneidplatte ohne Halterausbau
- der größere Abstand zur Führungsbuchse ist zu beachten

Tool holder with off line insert seat and square shank for parting-off

- Easy insert change without removing holder from turret
- Note the distance to guide bush.

Державка с квадратным хвостовиком для отрезки коротких деталей

- Быстрая замена пластины без снятия державки
- При настройке необходимо учитывать рабочее пространство до шпинделя.

2

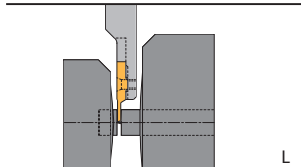

Einsatz mit Wendschneidplatte: LAB 08...F L-R.
 Illustration with Insert: LAB 08...F L/R
 На иллюстрации показана пластина: LAB 08...F L-R

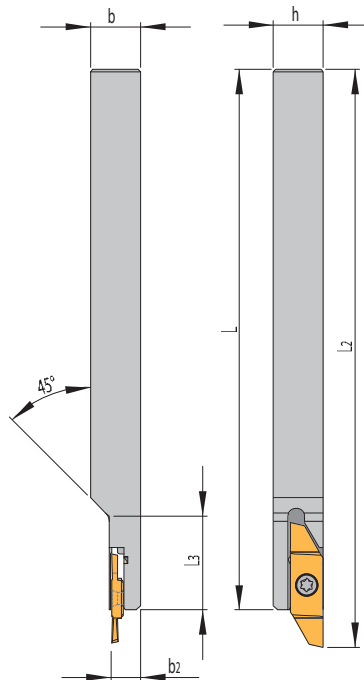

Halter / Holder / Державка

Bezeichnung Designation Обозначение	h	b	b ₂	L	L ₃	Wendschneidplatte Indexable Inserts Пластина
SLXO L 1212 X08-130	12	12	7,5	130	30	L..08...
SLXO L 1616 X08-130	16	16	7,5	130	40	L..08...

Ersatzteile / Spare parts / Комплекующие

Bezeichnung Designation Обозначение	Schraube Screw Винт	Torxschlüssel Torx-Key Торх-Ключ
SLAO R/L 0808	AS0027	KS1111
SLAO R/L 1010 bis 2020	AS0028	KS1111
SLCO N X08	AS0028	KS1111
SLXO	AS0029	KS1111



Wendeschneidplatten
Indexable inserts
Сменные пластины

2

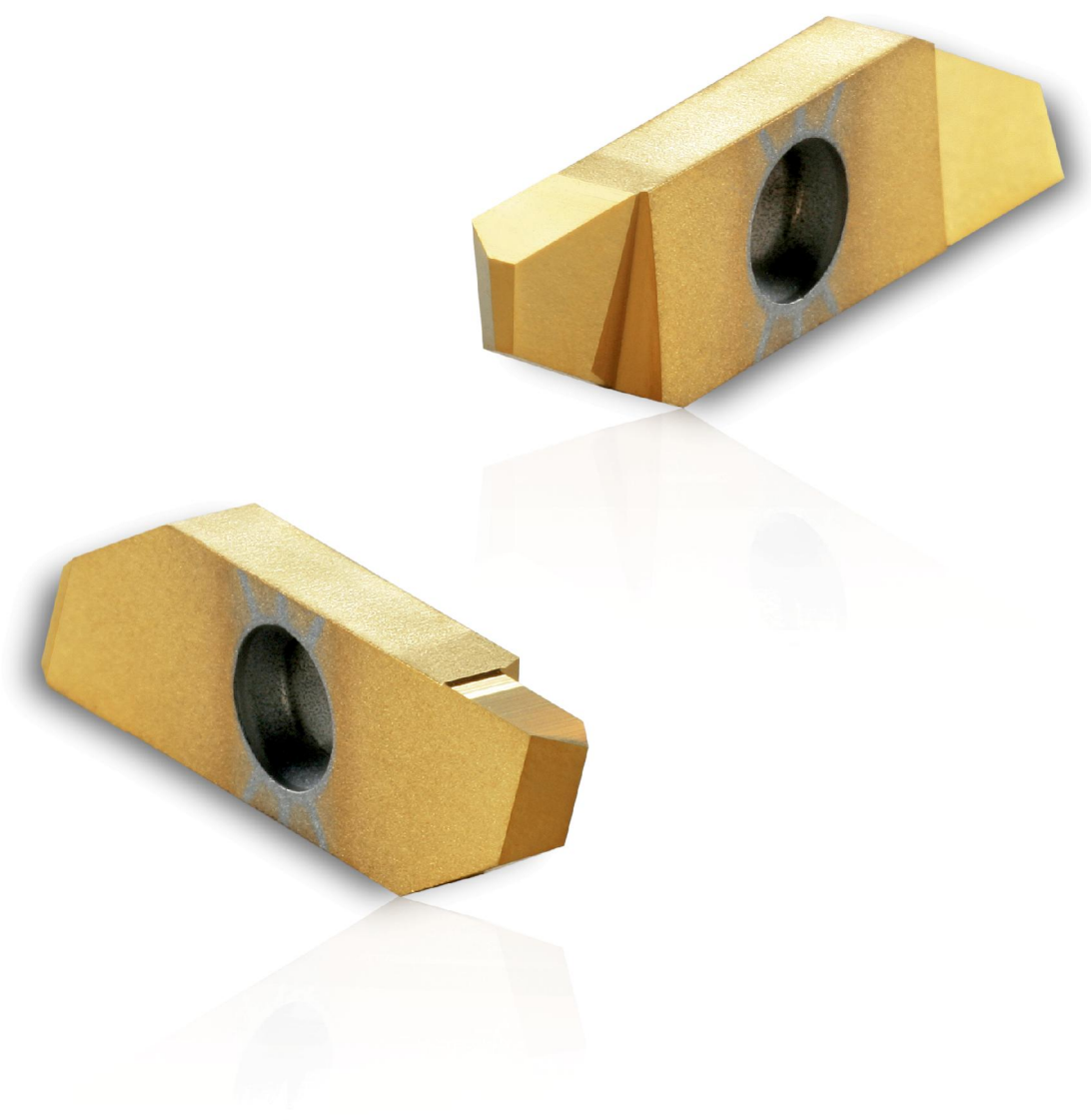



Wendeschneidplatten zum Abstechen
Part-off
Пластины для отрезки

Abstechplatten mit 0° Spanwinkel

- für Automatenstähle und legierte Stähle
- zum Abstechen kleiner Durchmesser
- einfach nachschleifbar
- auf allen Haltern einsetzbar

Part-off insert with 0° chip breaker

- for steel and alloy steel
- for parting off small diameters
- easy to re-grind
- can be used on all holders

Пластины для отрезки с передним углом 0°

- для нелегированных и легированных сталей
- для отрезки малых диаметров
- лёгкая переточка
- используется на всех типах державок

2

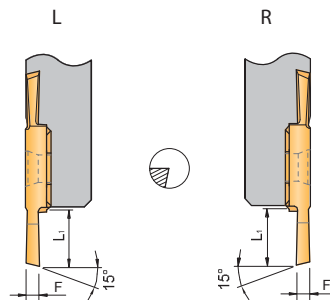

Wendeschneidplatten / Indexable inserts / Пластины

Bezeichnung Designation Обозначение	Sorten / Grades / Сплавы				
	F	L ₁	AP4020	AP5020	AK1020
LAB 080804F R/L	0,8	4,0	●	●	●
LAB 081005F R/L	1,0	5,0	●	●	●
LAB 081205F R/L	1,2	5,0	●	●	●
LAB 081507F R/L	1,5	7,0	●	●	●
LAB 082085F R/L	2,0	8,5	●	●	●
LAB 082585F R/L	2,5	8,5	●	●	●

Abstechplatten mit 4° Spanwinkel

- zum Abstechen von exotischen Werkstoffen die einen weicheren Schnitt erfordern.
- Einsatz auf Standardhaltern

Part-off insert with 4° chip breaker

- for exotic materials which requires softer cutting geometry
- for use on standard holders

Пластины для отрезки с передним углом 4°

- для экзотических, мягких материалов, требующих специальной геометрии
- используется на стандартных державках

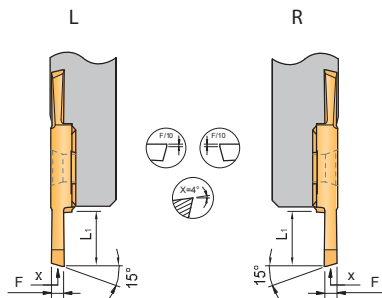
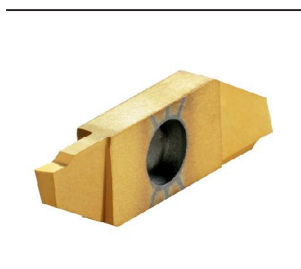

Wendeschneidplatten / Indexable inserts / Пластины

Bezeichnung Designation Обозначение	Sorten / Grades / Сплавы				
	F	L ₁	AP4020	AP5020	AK1020
LAB 081507F R/L -PF	1,5	7,0	●	●	●
LAB 082085F R/L -PF	2,0	8,5	●	●	●

Hinweis: Schneide um 0,4 mm unter Mitte. Muss an der Maschine korrigiert werden. / Information: Set at 0.4mm below centre, adjust at machine. / Информация: Режущая кромка находится на 0,4 мм ниже высоты державки. Это необходимо учесть при наладке при наладке станка.



Wendeschneidplatten zum Abstechen

Part-off

Пластины для отрезки

Abstechplatten links/rechts versetzt mit 0° Spanwinkel

- für Automatenstähle und legierte Stähle
- zum Abstechen kleiner Durchmesser nahe der Abgreifspindel
- in Kombination mit SLXO... Abstechhaltern



Part-off inserts off line with 0° chip breaker

- for steel and alloy steel
- for parting off small diameters close to the sub spindle
- use with holders SLXO..., note colour coding.

Пластины для отрезки с передним углом 0°

- для нелегированных и легированных сталей
- для отрезки малых диаметров вблизи шпинделя
- используется с державкой SLXO... см. цветовую кодировку.

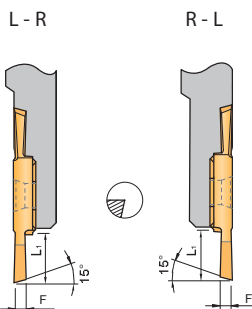

F L-R = versetztes Rechtsschneiden
 F R-L = versetztes Linksschneiden
 F L/R = Off-line right hand cutting
 F R/L = Off-line left hand cutting
 F L-R = отрезка в правостороннем исполнении
 F R-L = отрезка в левостороннем исполнении

Wendeschneidplatten / Indexable inserts / Сменные пластины

Bezeichnung Designation Обозначение	F	L ₁	Sorten / Grades / Сплавы		
			AP4020	AP5020	AK1020
LAB 081507F L-R	1,5	7,0	●	●	●
LAB 082085F L-R	2,0	8,5	●	●	●
LAB 082085F R-L	2,0	8,5	●	●	●

Achtung: Farbzuordnung beachten! / *Note: Colour coding!* / Информация: выбор инструмента производится в соответствии с цветовой кодировкой

Abstechplatten links versetzt mit 4° Spanwinkel

- für exotische Werkstoffe die einen weichen Schnitt erfordern.
- Abstechen nahe der Abgreifspindel
- in Kombination mit SLXOL... Abstechhaltern



Part-off insert off line right hand cutting with 4° chip breaker

- for exotic materials which require softer cutting geometry
- for parting off close to the sub spindle
- use with holders SLXO..., note colour coding.

Troncatura destra con angolo di spoglia 4°

- для экзотических, мягких материалов, требующих специальной геометрии
- для отрезки малых диаметров вблизи шпинделя
- используется с державкой SLXO... см. цветовую кодировку.

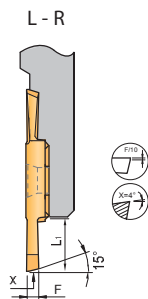

F L-R = versetztes Rechtsschneiden
 F L/R = Off-line right hand cutting
 F L-R = отрезка в правостороннем исполнении

Wendeschneidplatten / Indexable inserts / Сменные пластины

Bezeichnung Designation Обозначение	F	L ₁	Sorten / Grades / Сплавы		
			AP4020	AP5020	AK1020
LAB 081507F L-R-PF	1,5	7,0	●	●	●
LAB 082085F L-R-PF	2,0	8,5	●	●	●

Hinweis: Schneide um 0,4 mm unter Mitte. Muss an der Maschine korrigiert werden. / *Information: Set at 0.4mm below centre, adjust at machine.* / Информация: Режущая кромка находится на 0,4 мм ниже высоты державки. Это необходимо учесть при наладке станка.

Achtung: Farbzuordnung beachten! / *Note: Colour coding!* / Информация: выбор инструмента производится в соответствии с цветовой кодировкой





Einstecken und Drehen
Groove and turning
Обработка канавок и точение

Stechdrehplatte mit 0° Spanwinkel
 • zum Einstecken und Stechdrehen von kleinen Werkstückdurchmessern

Groove and turn insert with 0° chip breaker
 • for grooving and turning of small diameter components

Пластины для обработки канавок и точения с передним углом 0°
 • для обработки канавок и точения деталей малого диаметра

2

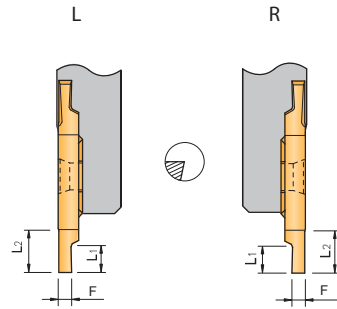
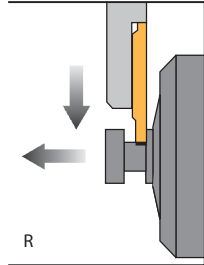
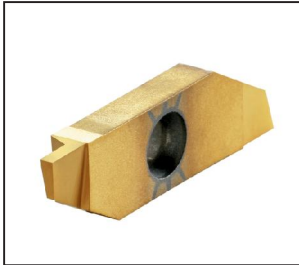

Wendeschneidplatten / Indexable inserts / Сменные пластины

Bezeichnung Designation Обозначение	Sorten / Grades / Сплавы						
	F	L ₁	L ₂	R	AP4020	AP5020	AK1020
	LST 080802F R/L	0,8	2,0	4,0	0,0	●	●
LST 081025F R/L	1,0	2,5	4,0	0,0	●	●	●
LST 081230F R/L	1,2	3,0	4,0	0,0	●	●	●
LST 081530F R/L	1,5	3,0	4,0	0,0	●	●	●
LST 082040F R/L	2,0	4,0	6,5	0,0	●	●	●
LST 082560F R/L	2,5	6,0	6,5	0,0	●	●	●
LST 083065F R/L	3,0	6,5	6,5	0,0	●	●	●



Einstecken und Drehen
Groove and turning
Обработка канавок и точение

Stechdrehplatten mit Zwei-Flächen-hliff

- zum Einstecken und Stechdrehen von exotischen Werkstoffen (z.B. Titanlegierungen) sowie rostfreien Stählen.
- beide Hauptschneiden sind komplett auf einer Höhe und haben jeweils einen Spanwinkel von 10°

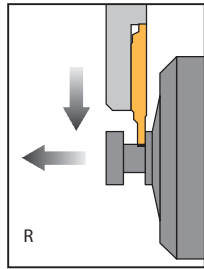
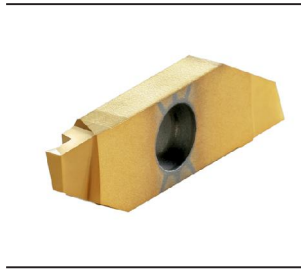

Groove and turn inserts with 2 ground chip breakers

- for grooving and turning of exotic materials as well as stainless steel
- both main edges are on same height and both have 10° chip breakers

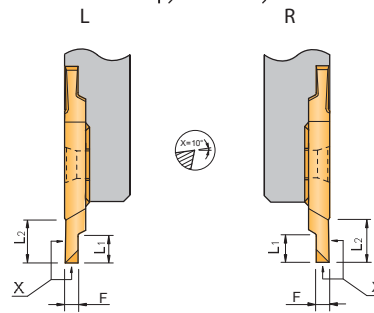

Пластины для обработки канавок и точения с двойным шлифованным стружколомом

- для обработки канавок и точения экзотических материалов и нержавеющей стали
- режущие кромки расположены на высоте линии центров, передняя поверхность имеет стружколом с углом 10°

2

Wendeschneidplatten / Indexable inserts / Сменные пластины

Bezeichnung Designation Обозначение	Sorten / Grades / Сплавы						
	F	L ₁	L ₂	R	AP4020	AP5020	AK1020
	LST 081025F R/L -P	1,0	2,5	4,0	0,0	●	●
LST 081230F R/L -P	1,2	3,0	4,0	0,0	●	●	●
LST 081530F R/L -P	1,5	3,0	4,0	0,0	●	●	●
LST 082040F R/L -P	2,0	4,0	6,5	0,0	●	●	●
LST 082560F R/L -P	2,5	6,0	6,5	0,0	●	●	●
LST 083065F R/L -P	3,0	6,5	6,5	0,0	●	●	●



Drehen
Turning
Точение

Drehplatte mit 0° Spanwinkel

- zum Drehen kleiner Durchmesser
- wahlweise mit 90° oder 92° Einstellwinkel

Turning insert with 0° chip breaker

- for turning small diameters
- optional 90° or 92° approach angle

Пластины для точения с передним углом 0°

- для обработки малых диаметров
- два варианта главного угла в плане 90° и 92°

2

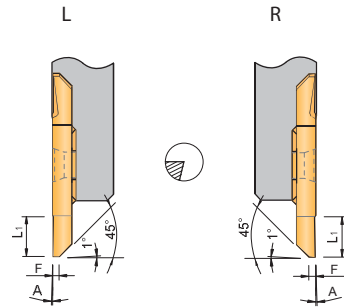
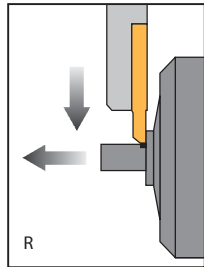
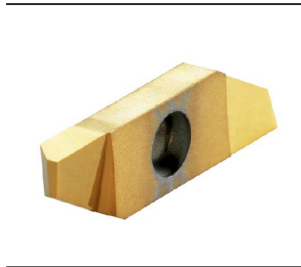

Wendeschneidplatten / Indexable inserts / Сменные пластины

Bezeichnung Designation Обозначение	Sorten / Grades / Сплавы					
	F	L ₁	A	AP4020	AP5020	AK1020
	LVD 08-0F R/L	1,0	6,5	90°	●	●
LVD 08-2F R/L	1,0	6,5	92°	●	●	●

Drehen mit je 10° Spanwinkel durch Zwei-Flächen-Anschliff

- für exotische Werkstoffe (z.B. Titan-legierungen) und rostfreie Stähle
- wahlweise mit 90° oder 92° Einstellwinkel

Turning insert with 2 ground 10° chip breakers

- for turning of exotic materials as well as stainless steel
- optional 90° or 92° approach angle

Сменные пластины с двойным стружколомом и передним углом 10°

- для точения деталей из экзотических материалов и нержавеющей стали.
- два варианта главного угла в плане 90° и 92°

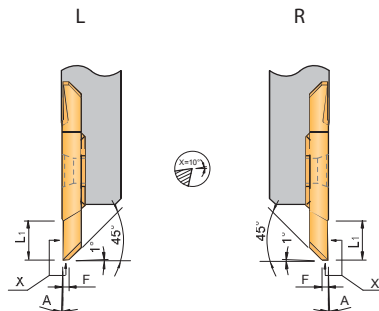
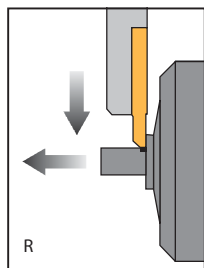
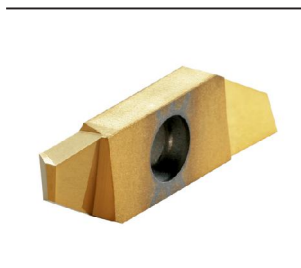

Wendeschneidplatten / Indexable inserts / Сменные пластины

Bezeichnung Designation Обозначение	Sorten / Grades / Сплавы					
	F	L ₁	A	AP4020	AP5020	AK1020
	LVD 08-0F R/L -P	1,0	6,5	90°	●	●
LVD 08-2F R/L -P	1,0	6,5	92°	●	●	●

Schneidkantenausführung siehe Infoteil / Cutting edge information available in Info section / Описание геометрии режущей части находится в разделе информации.



Gewindedrehen Threading Нарезание резьбы

Gewindedrehen Teilprofil 60°

- links und rechts steigend einsetzbar bis 3° Steigungswinkel
- linker Halter bei rechtssteigendem Gewinde: Für höhere Stabilität bei langen Gewinden, da die Stange in der Führungsbuchse bleibt (siehe Bild L).

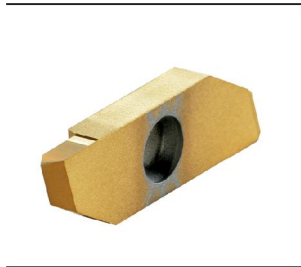

60° partial profile thread form

- for left and right hand threading
- for Metric and UN threads
- use left hand holder for right hand thread when threading long threads, improves stability (see picture L).

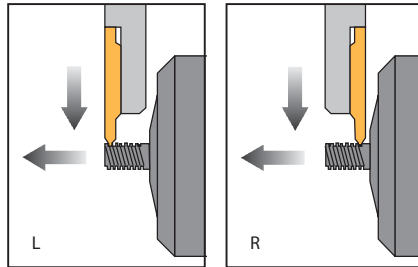

Неполный профиль 60°

- для левой и правой резьбы с углом подъема до 3°
- для метрической и UN резьб
- для достижения лучшей стабильности при нарезании длинной резьбы, рекомендуется использовать левое исполнение державки для нарезания правой резьбы (см. рис. L)

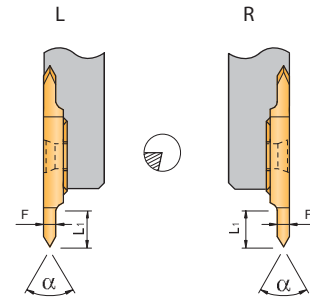

2

Wendeschneidplatten / Indexable inserts / Сменные пластины

Bezeichnung Designation Обозначение	Sorten / Grades / Сплавы					
	F	L ₁	α			
LGE 08-60F R/L	2,0	6,0	60°	AP4020	AP5020	AK1020

- Hinweis** Weitere Gewindeprofile auf Anfrage erhältlich.
Information Other thread forms available on request.
Информация: Пластины для резьбы другого профиля доступны по запросу.



Drehen hinter Bund (Rückwärtsdrehen)
Back Turning
Обратное точение

Stechdrehen hinter Bund mit 0° Spanwinkel

- für die Bearbeitung kleiner Durchmesser
- Einstellwinkel 70°

Back turning inserts with 0° chip breaker

- for machining of small diameters
- approach angle of 70°

Пластины для обратного точения с передним углом 0°

- для обработки малых диаметров
- угол в плане 70°

2

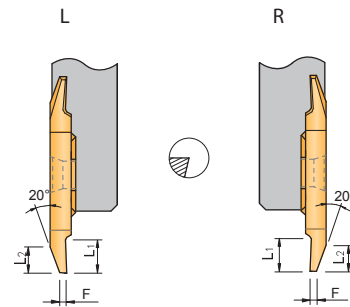
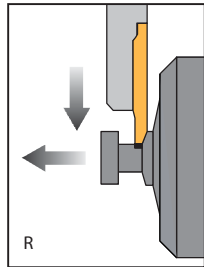
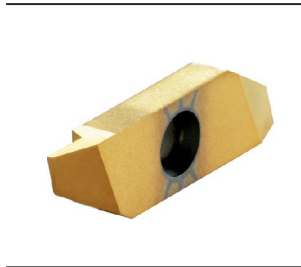

Wendeschneidplatten / Indexable inserts / Сменные пластины

Bezeichnung Designation Обозначение	Sorten / Grades / Сплавы					
	F	L ₁	L ₂	AP4020	AP5020	AK1020
	LRD 080504F R/L	0,5	4,0	4,0	●	●
LRD 081050F R/L	1,0	5,0	4,0	●	●	●

Stechdrehen hinter Bund je 10° Spanwinkel (Zwei-Flächen-Anschliff)

- für die Bearbeitung exotischer Werkstoffe (z.B. Titanlegierungen) und rostfreier Stähle
- der Bereich „X“ ist vollständig auf Drehmitte
- Einstellwinkel 70°

Back turning inserts with 10° chip breaker

- for turning of exotic materials as well as stainless steel
- the "X" dimension is exactly on centre
- approach angle of 70°

Пластины для обратного точения с передним углом 10°

- для обработки экзотических материалов (таких как титан) и нержавеющей стали
- кромки «X» находятся на линии высоты центров
- угол в плане 70°

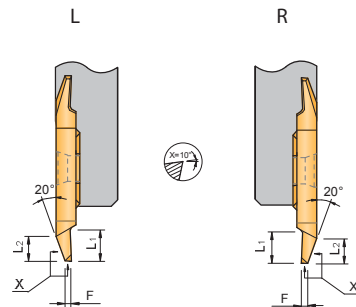
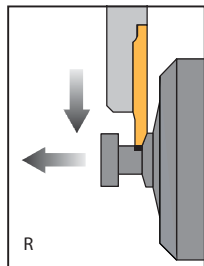

Wendeschneidplatten / Indexable inserts / Сменные пластины

Bezeichnung Designation Обозначение	Sorten / Grades / Сплавы					
	F	L ₁	L ₂	AP4020	AP5020	AK1020
	LRD 081050F R/L -P	1,0	5,0	4,0	●	●



Drehen hinter Bund (Rückwärtsdrehen)
Back Turning
Обратное точение

Stechdrehen hinter Bund mit 8° Spanwinkel

- für die Bearbeitung exotischer Werkstoffe (z.B. Titanlegierungen) und von rostfreier Stähle
- Einstellwinkel 55° für alternativen Spanabfluss

Back turning inserts with 8° chip breaker

- for turning of exotic materials as well as stainless steel
- approach angle of 55° for alternative chip evacuation

Пластины для обратного точения с передним углом 8°

- для обработки экзотических материалов (таких как титан) и нержавеющей стали.
- угол в плане 55° для альтернативного направления отвода стружки

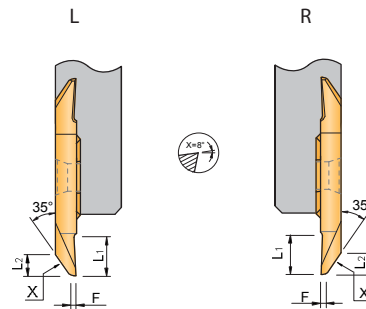
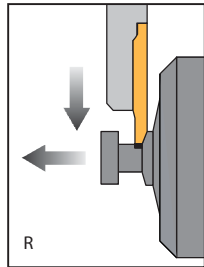
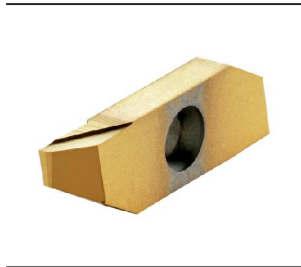

2

Wendeschneidplatten / Indexable inserts / Сменные пластины

Bezeichnung Designation Обозначение	Sorten / Grades / Сплавы					
	F	L ₁	L ₂	AP4020	AP5020	AK1020
	LRD 081060F R/L -SP	1,0	6,0	3,0	●	●

Hinweis: Schneide um 0,2 mm unter Mitte. Muss an der Maschine korrigiert werden.
 Information: Set at 0,2 mm below centre, adjust at machine.
 Информация: Режущая кромка находится на 0,2 мм ниже линии центров. Это необходимо учесть при наладке станка.



Rohling
Blanks
Заготовки пластин

Rohling für Sonderanwendungen
• Spanflächen poliert

Blanks for special applications
• Chip breaker polished

Заготовки для изготовления спецпластин
• Полированная передняя поверхность

2

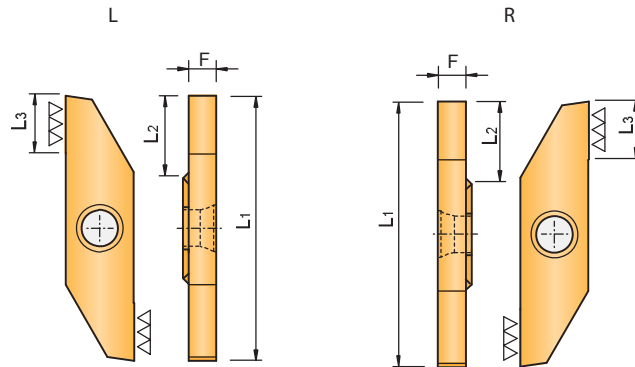
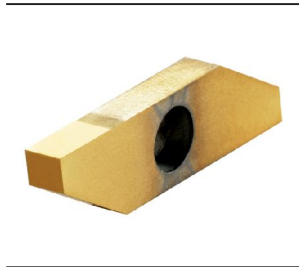

Wendeschneidplatten / Indexable inserts / Сменные пластины

Bezeichnung Designation Обозначение	Sorten / Grades / Сплавы						
	F	L ₁	L ₂	L ₃	AP4020	AP5020	AK1020
	LRO 08F R/L	- 3,2	- 30,5	- 9,2	- 6,5	●	●



Sorten
Grade
Сплавы

Hartmetall beschichtet / Carbide grade coated / Твёрдые сплавы с покрытием

AP4020 PVD Beschichtung, Substrat +TiN

Universelle Sorte für leichte Bearbeitung von NE-Metallen (Kupfer und Kupferlegierungen, Bronze, Messing) sowie Aluminium und Aluminiumlegierungen bei geringen Schnittgeschwindigkeiten. Bestens geeignet für die Bearbeitung von weichen Werkstoffen mit der Tendenz zur Bildung von Aufbauschneiden. Auch für die Zerspanung von Automatenstählen bei kleinsten Durchmessern geeignet. Sehr geringer Reibwert.

PVD coating, carbide + TiN

Universal grade for light machining of none ferrous materials (copper and copper alloys, bronze and brass) as well as aluminium and aluminium al-loys at low cutting speed. Very suitable for machining soft materials with tendency to create build up edge on the cutting edge. Also suitable for machining small diameter components in free cutting steel. Very low co-efficiency.

PVD покрытие, основа + TiN

Универсальный сплав для лёгкой обработки цветных металлов и сплавов (медь и медные сплавы), так же подходит для обработки алюминия и алюминиевых сплавов с низкими скоростями резания. Первый выбор для обработки мягких материалов с тенденцией наростообразования на режущей кромке. Так же применяется при обработке малых диаметров автоматных сталей.

AP5020 PVD-Mehrlagenbeschichtung, Substrat + TiAlN

Universelle Sorte für die allgemeine Stahlzerspanung. Auch geeignet für die Bearbeitung rostfreier Stähle, warmfester Legierungen sowie Titanlegierungen. Sehr gute Warmfestigkeit.

PVD coating, carbide + TiAlN

Suitable for general steel cutting, but also suitable for machining stainless steel, high temperature alloys as well as titanium alloys. Very good heat resistance.

PVD покрытие, основа + TiAlN

Основное применение - обработка сталей, но так же применяется для обработки нержавеющей сталей, жаропрочных и титановых сплавов. Обладает высокой термоустойчивостью.

AK1020 Verschleißfeste Feinkorn-Sorte. Geeignet für die Bearbeitung von Aluminium, Aluminiumlegierungen und exotischen Werkstoffen (Titan). Basissorte für kundenspezifische Beschichtungslösungen.

Uncoated grade Wear resistance fine grain grade. Suitable for machining aluminium, aluminium alloys and exotic materials (titanium). Base grade for customer specific coating solutions.

Сплав без покрытия

Износостойкий, мелкодисперсный сплав. Применяется для обработки алюминия, алюминиевых сплавов и экзотических материалов (титана).

Данный сплав является основой для нанесения специальных покрытий по заявкам клиентов.





Empfohlene Schnittwerte
 Recommended cutting data
 Рекомендуемые режимы резания

2

ISO		Schnittgeschwindigkeit / Cutting data / Режимы резания				
		Drehen / Turning / Точение		Abstechen / Parting-off / Отрезка		
		V _c [m/min]	f [mm/U]	V _c [m/min]	f [mm/U]	
P	Automatenstahl / Free cutting steel / Автоматная сталь		120 - 200	0,01 - 0,20	80 - 150	0,01 - 0,15
	Stahl / Steel / Сталь	< 600 N/mm ²	80 - 160	0,01 - 0,18	70 - 120	0,01 - 0,12
	Stahl / Steel / Сталь	< 800 N/mm ²	60 - 120	0,01 - 0,15	60 - 100	0,01 - 0,10
	Stahl / Steel / Сталь	> 800 N/mm ²	50 - 100	0,01 - 0,12	40 - 80	0,01 - 0,08
M	Rostfreie Stähle / Stainless steel / Нержавеющая сталь		60 - 120	0,01 - 0,15	60 - 100	0,01 - 0,08
N	Aluminium und AL-Legierungen / Aluminium and Aluminium alloys / Алюминий и алюминиевые сплавы		180 - 800	0,01 - 0,30	150 - 300	0,01 - 0,20
	Kupfer und Kupferlegierungen (Messing, Bronze) / Copper and Copper alloys (Brass, Bronze) / Медь и медные сплавы (Бронза, Латунь)		100 - 500	0,01 - 0,30	100 - 300	0,01 - 0,20
S	Titan / Titanium / Титан		30 - 70	0,01 - 0,12	30 - 50	0,01 - 0,06



Anwendungshinweise
Application information
Информация

Eckenradius / Corner radius / Радиус при вершине

Wenn nichts angegeben ist beträgt der Eckenradius der Schneidplatten R0,0mm. Die Schneidplatten erzeugen die guten Oberflächengüten mit einer Schleppschneide.

When nothing is advised the corner radius of the inserts is R0.0mm. The inserts achieve the excellent surface finish with wiper edge effect.

По умолчанию, если оговорено дополнительно, радиус при вершине составляет 0,0 мм. Инструмент позволяет получить отличное качество поверхности благодаря эффекту «Wiper».

Freiwinkel / Relief angle / Задний угол

Der Freiwinkel in Schnittrichtung beträgt bei allen Schneidplatten 7°, die Nebenfriewinkel haben 3°. Daher ist ein Einsatz in Richtung Nebenschneide nur bedingt möglich.

The relief angle for all inserts is 7°. The secondary relief angle is 3°. Therefore is the capability for secondary edge direction turning only limited.

Задний угол на всех пластинах составляет 7° вспомогательный угол в плане составляет 3°. Поэтому возможности использования вспомогательной режущей ограничены.

Ersatzteile / Spare parts / Комплектующие

Bezeichnung	Schraube	Torxschlüssel
Designation	Screw	Torx-Key
Обозначение	Винт	Ключ Torx
SLAO R/L 0808	AS0029	KS1111
SLAO R/L 1010 bis 2020	AS0028	KS1111
SLCO N X 08	AS0028	KS1111
SLXO	AS0029	KS1111



Einbaumaße der Wendeschneidplatte / Build dimensions of inserts / Присоединительные размеры

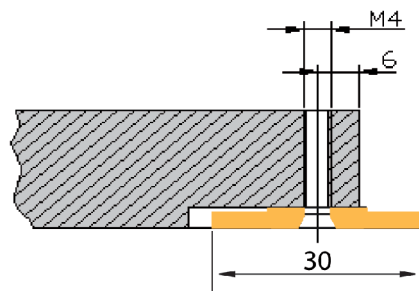

Berechnung des Steigungswinkels beim Gewindedrehen
threading / Расчёт угла наклона спирали резьбы

/ Calculation of helix angle for

Der Steigungswinkel des Gewindes bzw. der erforderliche Neigungswinkel ergibt sich aus folgender Formel:

The helix angle of the thread and the required inclination angle can be calculated by the following formula:

Угол наклона спирали резьбы и угол наклона передней поверхности пластины могут быть вычислены по следующей формуле.

$$\tan \lambda = \frac{p}{d_2 \times \pi}$$

- λ = Steigungswinkel / Inclination / Угол наклона
- d_2 = Flankendurchmesser / Pitch diameter / Средний диаметр резьбы
- p = Steigung / Pitch / Шаг резьбы

Hinweis: Darstellung in dem Katalog gelten für Maschinen mit rechts liegender Hauptspindel (z.B. Tornos, Maier,...)
Remark: Illustrations in the catalogue are based on machines the right hand main spindle (for example Tornos, Maier,...)
Информация: Иллюстрации в каталоге даны для случая правого вращения главного шпинделя.

Hinweis: Weitere Informationen finden Sie im Anhang des Kataloges Drehen und Gewindedrehen.
Remark: For further information on turning and threading please see our catalogue "Tools and Inserts for Turning and threading"
Информация: Для получения более полной информации, пожалуйста, смотрите наш каталог «Инструмент и сменные пластины для токарной обработки и нарезания резьбы»

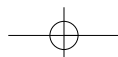



Notizen
Notes
Примечания

2

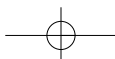
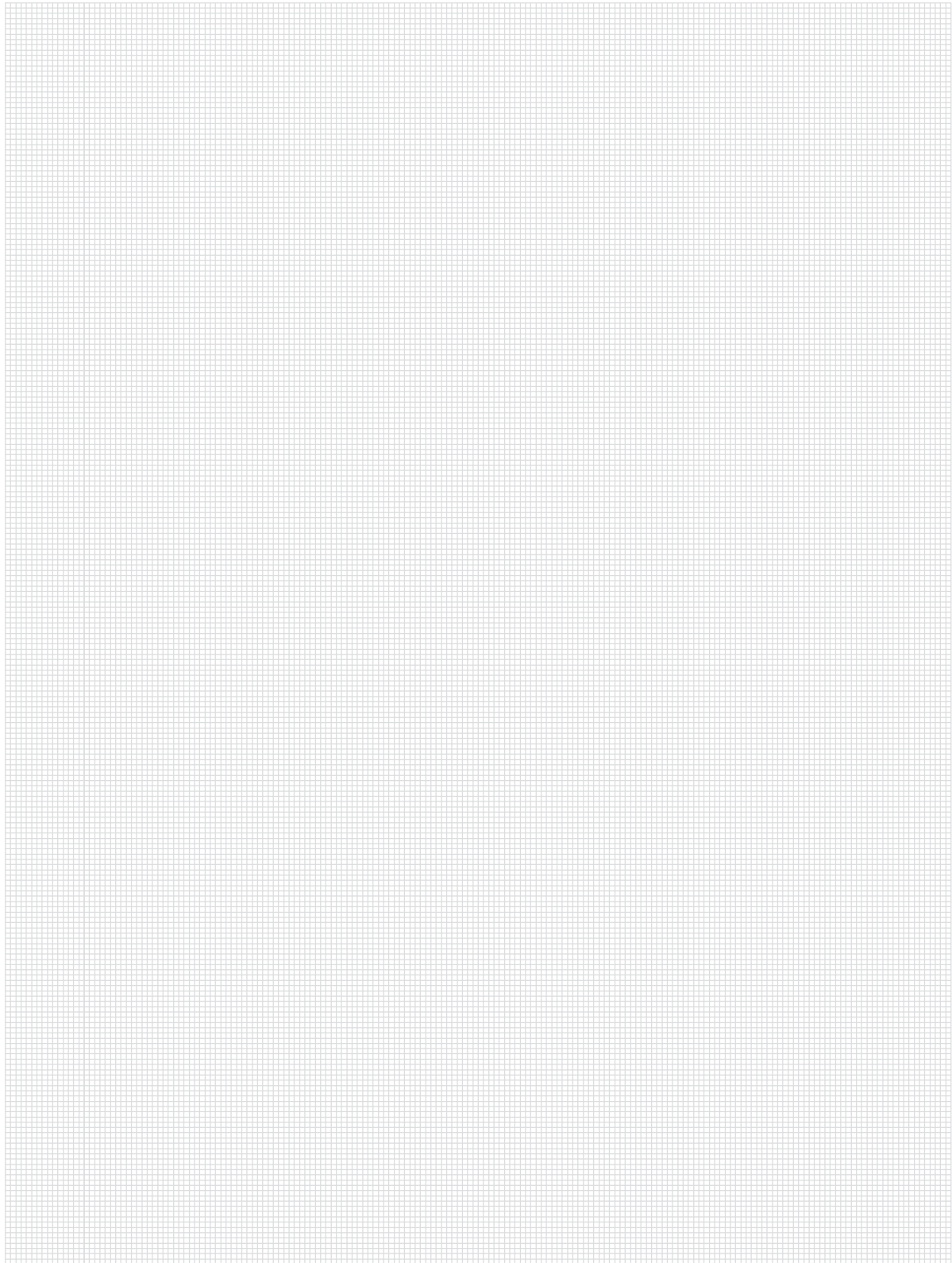



Werkzeuge und Schneideinsätze
zum Ein- und Abstechen
Tools and inserts
for parting and grooving
Инструмент и сменные пластины
Для отрезки и обработки канавок





Langdrehen
Screw machines
Токарные автоматы
продольного точения
(Швейцарский тип станков)

NC-Stechedrehen
NC-grooving

Langdrehen
Screw machines

EB = 0,5 - 3,0 mm
ET = - 12,0 mm

Seite 3.11 - 3.12
Ausführung / Design / Исполнение R L

SHORT-CUT

Langdrehen
Screw machines

EB = 2,1 - 5,1 mm
ET = - 9,5 mm

Seite 3.14
Ausführung / Design / Исполнение R L

CLIP-GROOVE

EB = 0,55 - 5,0 mm
ET = - 3,5 mm

Seite 3.6 - 3.7
Ausführung / Design / Исполнение R L

DROP-CUT

Langdrehen
Screw machines

EB = 2,1 - 3,1 mm
ET = - 16,0 mm

Seite 3.16
Ausführung / Design / Исполнение R L

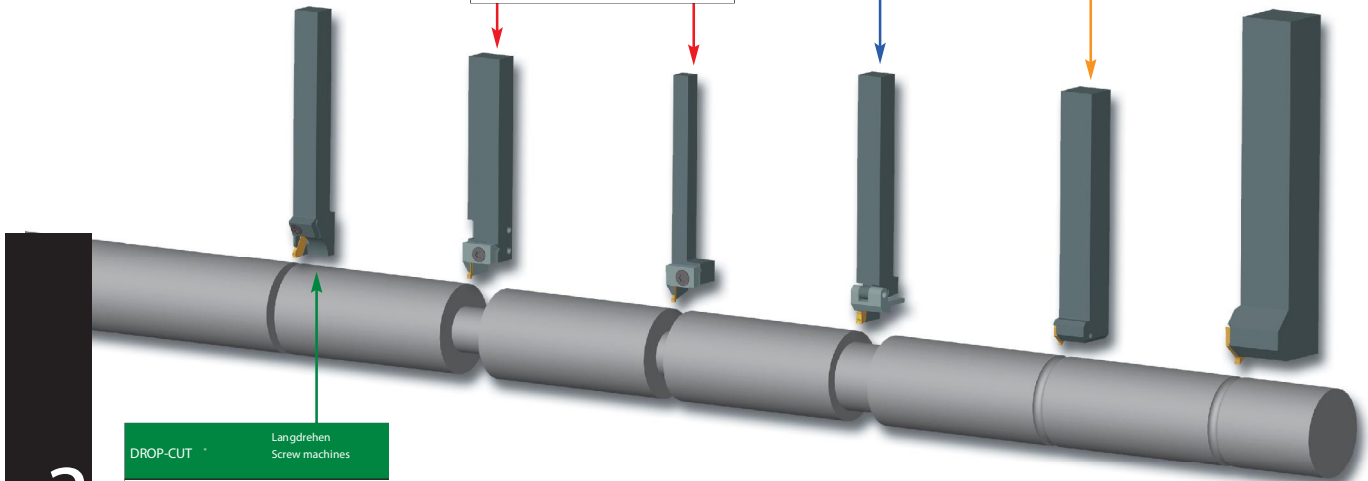

3

MICRO-Werkzeuge
MICRO tools

EB = -
ET = -
D_{min} = 2,2 mm

Seite 4.1 - 4.15
Ausführung / Design / Исполнение R L

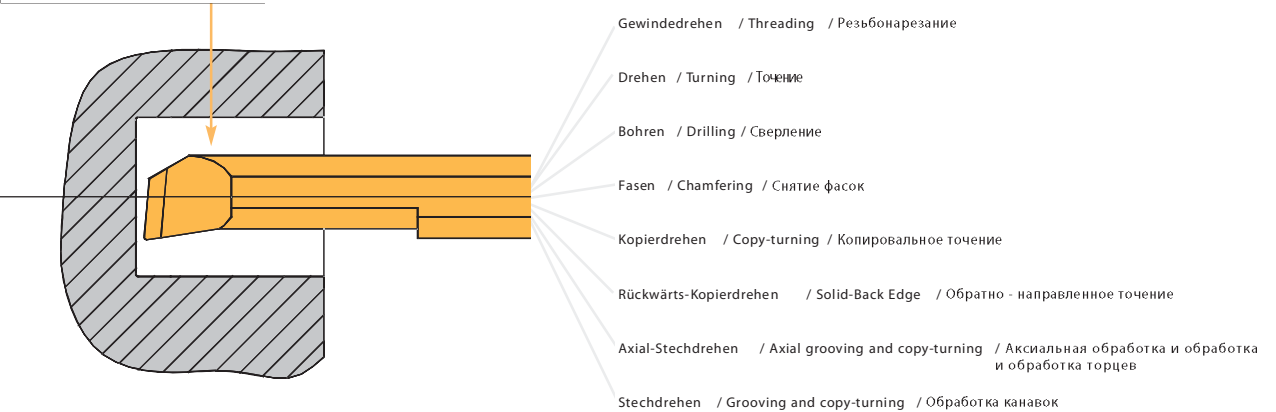

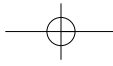

Inhalt
Contents
Содержание

CLIP-GROOVE °

3.5 - 3.8



NC-Stechedrehsystem
NC-groove and turning system
NC- обработка канавок
и система точения

3.9 - 3.12



SHORT-CUT °

3.13 - 3.14



DROP-CUT °

3.15 - 3.16

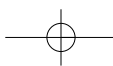

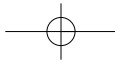

Notizen
Notes
Примечания

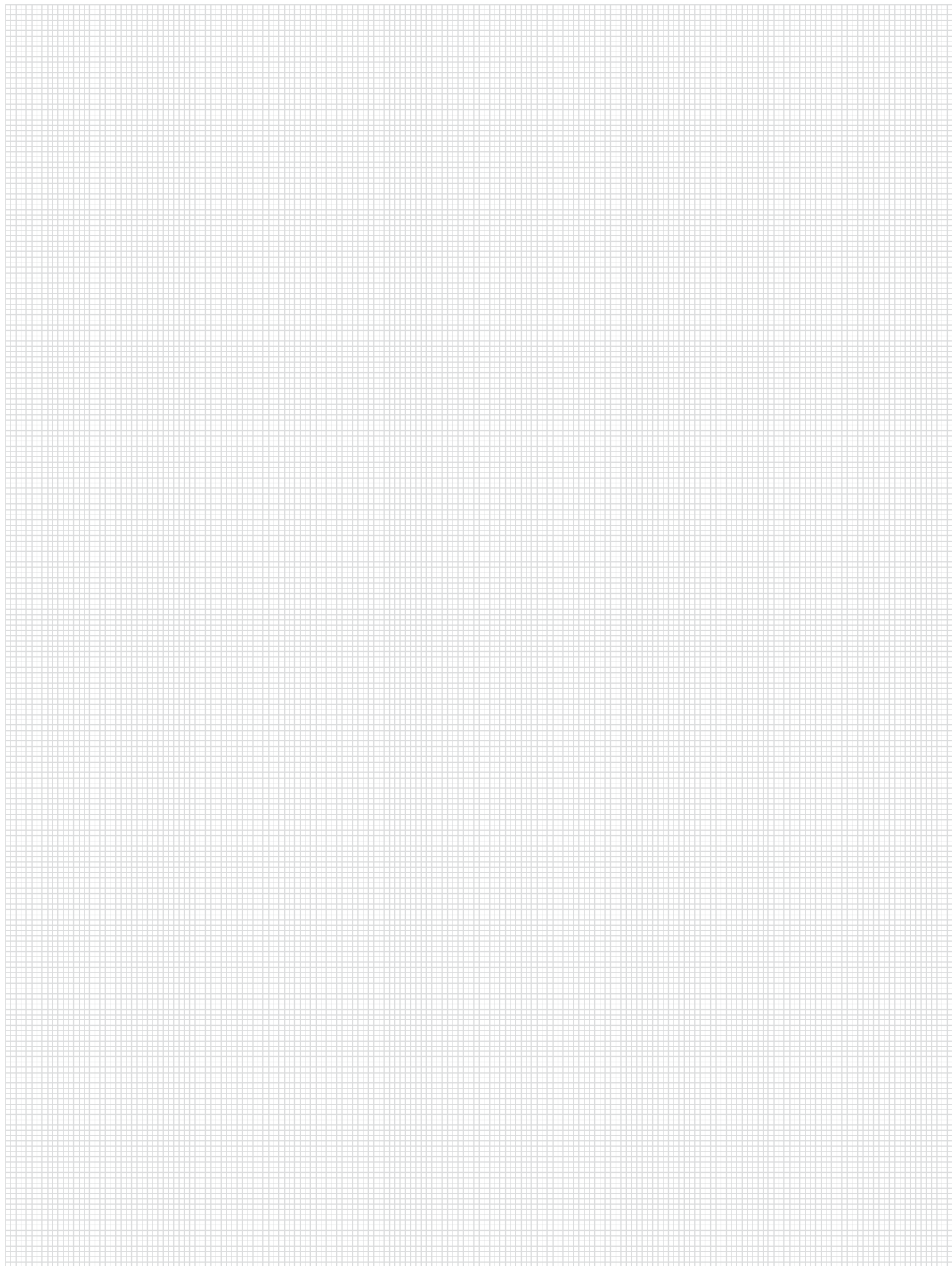

3

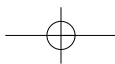

CLIP-GROOVE[®]



3

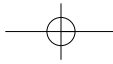

Radial Stechen
Radial grooving
Обработка радиальных канавок

CLIP-GROOVE®

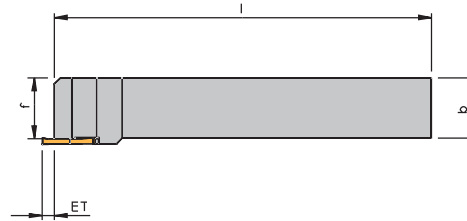
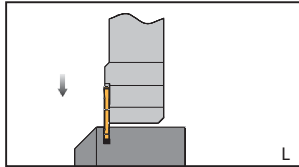
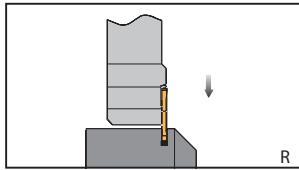

Rechte Ausführung abgebildet
Right-hand execution shown
Показано правостороннее исполнение

Grundhalter / Holder / Державки

Bezeichnung Designation Обозначение	$h = h_1$	b	l	f	ET	h_2	k	Schneideinsatz Grooving insert Пластины
STGO R/L 1010E17 -A7	10	10	70	10,0	2,0 [Ⓢ]	5,0	17,5	TNNU 17...
STGO R/L 1212F17 -A7	12	12	80	12,0	2,0 [Ⓢ]	5,0	17,5	TNNU 17...
STGO R/L 1616J17 -A7	16	16	110	16,0	2,0 [Ⓢ]	5,0	17,5	TNNU 17...
STGO R/L 1616J17 -A7/3 [Ⓢ]	16	16	110	14,8	2,0 [Ⓢ]	5,0	17,5	TNNU 17...
STGO R/L 2020K17 -A7	20	20	125	20,0	2,0 [Ⓢ]	5,0	17,5	TNNU 17...
STGO R/L 2020K17 -A7/3 [Ⓢ]	20	20	125	18,8	2,0 [Ⓢ]	5,0	17,5	TNNU 17...
STGO R/L 1616J31 -A7	16	16	110	16,0	3,5 [Ⓢ]	8,5	22,5	TNNU 31...
STGO R/L 1616J31 -A7/4 [Ⓢ]	16	16	110	13,8	3,5 [Ⓢ]	8,5	22,5	TNNU 31...
STGO R/L 2020K31 -A7	20	20	125	20,0	3,5 [Ⓢ]	8,5	22,5	TNNU 31...
STGO R/L 2020K31 -A7/4 [Ⓢ]	20	20	125	17,8	3,5 [Ⓢ]	8,5	22,5	TNNU 31...

Ⓢ Bei Wendeschneidplatten $B < 1,6$ mm ist die Stechtiefe durch das Maß „f“ begrenzt.
Cutting depth is limited by the dimension „f“ if cutting with $B < 1,6$ mm for grooving insert.
Глубина обработки ограничена размером „f“, если размер пластины $B < 1,6$ у канавочных пластин.

Ⓢ Für den Halter STGO R/L ... /3 Schneideinsatz ab TNMU 1730F R/L verwenden!
For the toolholder STGO R/L ... /3 inserts up to TNMU 1730F R/L must be used!
Совместно с державкой STGO R/L ... /3 могут применяться пластины TNMU 1730F R/L!

Hinweis: Werkzeugsystem auch für Sonderprofile bis Stechbreite 7 mm geeignet.
Information: Our tool-system can also be used for special profiles up to grooving width 7 mm.
Информация: Наша система инструмента может так же использоваться для обработки канавок специального профиля шириной до 7мм

Ersatzteile / Spare parts / Комплекующие

Halter	Schraube	Schlüssel
Holder	Screw	Key
Державки	Винт	Ключ
STGO R/L ..17-...	AS 0007	KS 1751
STGO R/L ..31-...	AS 0002	KS 1111

Hinweis: Passende Wendeschneidplatten finden Sie in unserem Katalog "Werkzeuge und Schneideinsätze zum Ein- und Abstechen".

Remark: Inserts to suit you can find in our catalogue "Tools and Inserts for grooving and parting-off"

Примечание: сменные пластины вы можете найти в каталоге «Инструмент и сменные пластины для отрезки и обработки канавок»

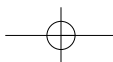

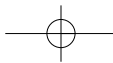

Innenstechdrehen
Internal grooving
Обработка торцевых канавок

CLIP-GROOVE®

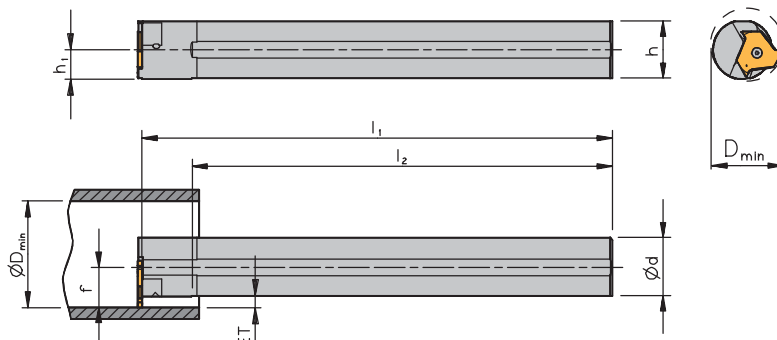
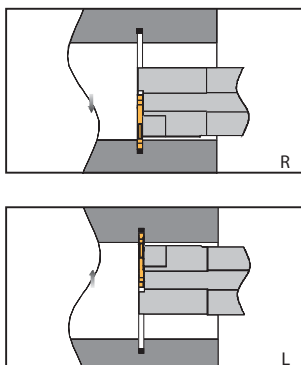

Rechte Ausführung abgebildet
Right-hand execution shown
Показано правостороннее использование

Halter / Holder / Державка

Bezeichnung Designation Обозначение	Ø d	h	h ₁	l ₁	l ₂	f	ET	D _{min}	Schneideinsatz Grooving insert Пластини
A12K STFO R/L 1716	12	11	6,0	125	100	8,5	2 ^Φ	16	TN MU 17...
A16M STFO R/L 1716	16	15	8,0	150	115	8,5	2 ^Φ	16	TN MU 17...

- Bei Wendschneidplatten B < 1,6 mm ist die Stechtiefe durch das Maß „f“ begrenzt.
Cutting depth is limited by the dimension „f“ if cutting with B < 1,6 mm for grooving insert.
Глубина обработки ограничена размером „f“, если размер пластины B < 1,6 у канавочных пластин.
- Nur bis Stechbreite EB = 2mm
Only up to range of width EB = 2mm
Только для обработки размеров шириной до EB = 2mm



Hinweis Bei Halter für TNMU 17..., Schneidkante 0,5 mm über Mitte. Werkzeuge für die Innenbearbeitung „Dmin“ kleiner 12 mm siehe ab Seite 4.1.
Information With the support for the TNMU 17, cutting edge 0.5 via the middle. Tools for the inside processing „Dmin“ smaller 12 mm. Refer to page 4.1 and following.
Информация: При обработке диаметром „Dmin“ меньше 12 мм, перейдите на страницу 4.1 и последующие

- Bitte beachten:** Rechter Halter → Linker Schneideinsatz
Linker Halter → Rechter Schneideinsatz
- Please note:** Holder right-hand design → Left-hand grooving insert
Holder left-hand design → Right-hand grooving insert
- Примечание:** Правосторонняя державка → Левосторонняя пластина
Левосторонняя державка → Правосторонняя пластина

Ersatzteile / Spare parts / Комплекующие

Halter	Schraube	Schlüssel
Holder	Screw	Key
Державка	Винт	Ключ
STFO R/L ..17-...	AS 0007	KS 1751

Hinweis: Passende Wendschneidplatten finden Sie in unserem Katalog "Werkzeuge und Schneideinsätze zum Ein- und Abstechen".

Remark: Inserts to suit you can find in our catalogue "Tools and Inserts for grooving and parting-off".

Примечание: Сменные пластины вы можете найти в каталоге «Инструмент и сменные пластины для резки и обработки канавок»

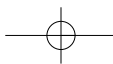



Anwendungshinweise Application Варианты применения

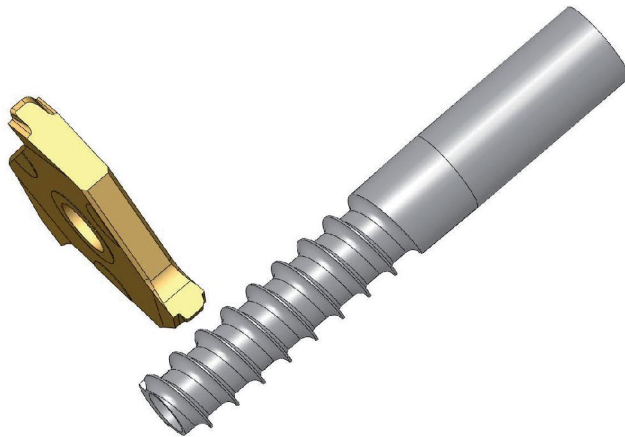

Branche: Medizintechnik
 Bearbeitung: Gewindestrehlen an Knochenschrauben
 Material: Ti6Al4V
 Besonderheit: Exotisches Material und Sondergewinde

Vorteile Clip-Groove-System:

- 3 schneidige Wendeschneidplatte
- 3 verschiedene WSP-Sorten -> 2 Hartmetallsorten -> 1 Cermet-Sorte
 CBN- und PKD-Bestückung möglich
- Nahezu jede schleiftechnisch herstellbare Form möglich
- Stechbreiten von 0,5 - 7 mm (ETmax je nach Kontur)

Industry: Medical
 Application: Threading of bone screws
 Material: Ti6Al4V
 Problem: exotic material and special thread
 Solution: Special Clip-Groove tooling

Advantages of the Clip-groove system

- 3 edged insert
- 3 different grades = 2 carbide and 1 cermet.
- CBN and PKD also possible
- Available for nearly any form which can be ground
- Groove width from 0.5-7.0mm (groove depth depending on form)

Промышленность: Медицинская
 Применение: Нарезание резьбы костного винта
 Материал: Ti6Al4V
 Проблема: Экзотический материал и специфическая резьба
 Решение: Специальный Clip-Groove инструмент

Преимущества системы Clip Groove:

- 3 режущих кромки
- 3 варианта сплава: 2 твёрдых сплава и 1 металлокерамика
- По запросу доступны CBN и PKD режущие материалы
- Возможность изготовления большого многообразия профилей режущей кромки
- Диапазон ширины от 0,5 до 7 мм (глубина реза зависит от ширины)

Branche: Maschinen- und Anlagenbau
 Bearbeitung: Drehen von Rundgewinde
 Material: 31CrMoV9

Vorteile Clip-Groove-System:

- 3 schneidige Wendeschneidplatte
- 3 verschiedene WSP-Sorten -> 2 Hartmetallsorten -> 1 Cermet-Sorte
 CBN- und PKD-Bestückung möglich
- Nahezu jede schleiftechnisch herstellbare Form möglich
- Stechbreiten von 0,5 - 7 mm (ETmax je nach Kontur)

Industry: Machine construction
 Application: Threading of round thread
 Material: 31CrMoV9
 Solution: Special Clip-Groove tooling

Advantages of the Clip-groove system

- 3 edged insert
- 3 different grades = 2 carbide and 1 cermet.
- CBN and PKD also possible
- Available for nearly any form which can be ground
- Groove width from 0.5-7.0mm (groove depth depending on form)

Промышленность: Машиностроение
 Применение: Нарезание резьбы круглого профиля
 Материал: 31CrMoV9
 Решение: Специальный Clip-Groove инструмент

Преимущества системы Clip Groove:

- 3 режущих кромки
- 3 варианта сплава: 2 твёрдых сплава и 1 металлокерамика
- По запросу доступны CBN и PKD режущие материалы
- Возможность изготовления большого многообразия профилей режущей кромки
- Диапазон ширины от 0,5 до 7 мм (глубина реза зависит от ширины)

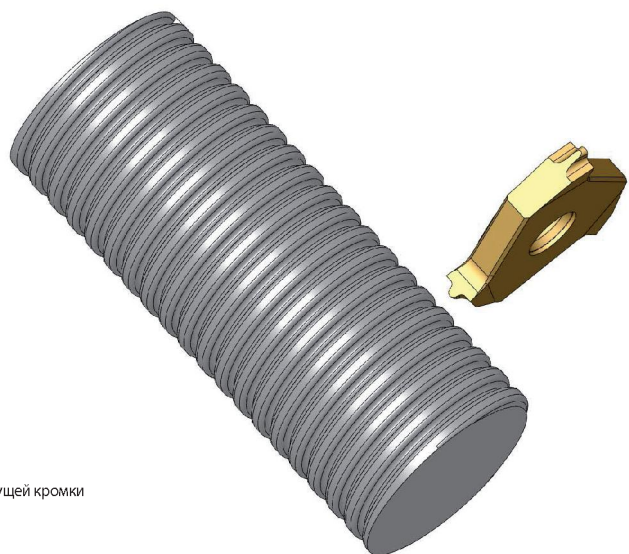



NC-Stechedrehsystem
NC-groove and turning system
NC-Обработка канавок
и система точения



3



Notizen
Notes
Примечания

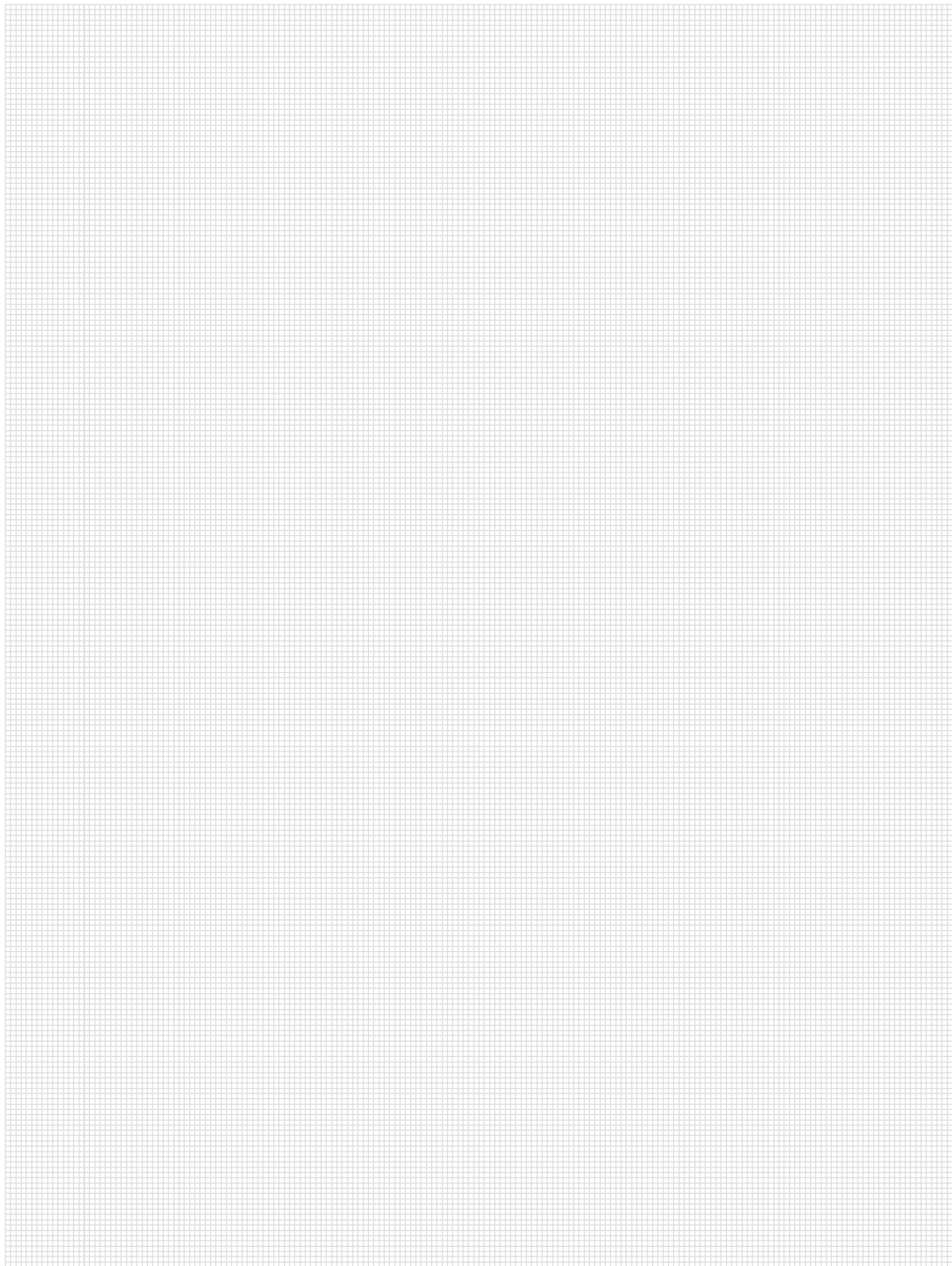

3

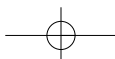



Radial-Stechdrehen **gerade**
 Radial grooving straight
 Радиальная обработка - прямая

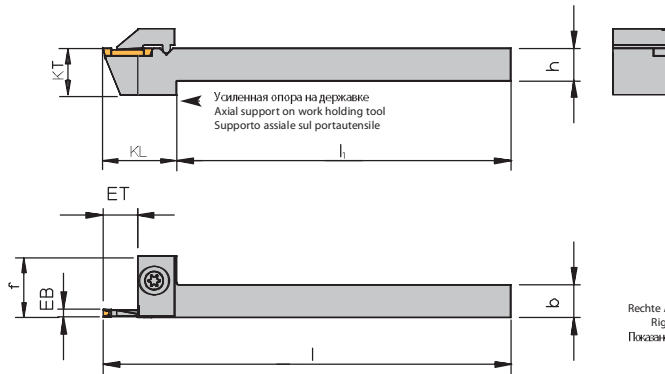
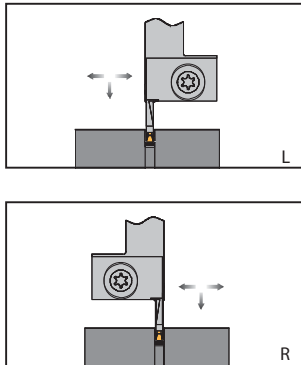

Rechte Ausführung abgebildet
 Right-hand execution shown
 Показано правостороннее исполнение

Grundhalter / Holder / Державка

Bezeichnung Designation Обозначение	h	b	l	l ₁	f
70808-2R/L	8	8	100	82	15
71010-2R/L	10	10	100	82	15
71212-2R/L	12	12	100	82	15
71616-2R/L	16	16	100	82	16
70808-3R/L	8	8	100	82	15
71010-3R/L	10	10	100	82	15
71212-3R/L	12	12	100	82	15
71616-3R/L	16	16	100	82	16

Zubehör / Spare parts / Комплектующие

Bezeichnung Designation Обозначение	EB	ET	KL	KT	Klemme Clamp Прижим	Schneideinsätze Grooving insert Пластина	Schraube Screw Винт	Schlüssel Key Ключ
70808-2R/L	2	8	18	12	KAM 2 R/L	212...	T 154	KS 1111
71010-2R/L	2	8	18	12	KAM 2 R/L	212...	T 154	KS 1111
71212-2R/L	2	8	18	12	KAM 2 R/L	212...	T 154	KS 1111
71616-2R/L	2	8	18	16	KAM 2 R/L	212...	T 154	KS 1111
70808-3R/L	3	8	18	12	KAML 3 R/L	316...	T 154	KS 1111
71010-3R/L	3	8	18	12	KAML 3 R/L	316...	T 154	KS 1111
71212-3R/L	3	8	18	12	KAML 3 R/L	316...	T 154	KS 1111
71616-3R/L	3	8	18	16	KAML 3 R/L	316...	T 154	KS 1111

Grundhalter werden mit Schrauben und Schlüssel geliefert, jedoch ohne Klemme.
 Holders will be supplied with screws and key, however without clamp.
 В комплект поставки входит винт и ключ, модуль и прижим в комплект поставки не входят

Hinweis: Grundhalter muss in axialer Richtung an der Werkzeugaufnahme anliegen!
 Information: Basic holder must be adapted in axial direction on to the work holding tool!
 Информация: Базовая державка должна быть адаптирована к патрону станка в аксиальном направлении!

Hinweis: Passende Wendeschneidplatten finden Sie in unserem Katalog "Werkzeuge und Schneideinsätze zum Ein- und Abstechen".

Remark: Inserts to suit you can find in our catalogue "Tools and Inserts for grooving and parting-off".

Примечание: Сменные пластины вы можете найти в каталоге «Инструмент и сменные пластины для отрезки и обработки канавок»





SIN-Bohrstangen
 SIN-boring bars
 SIN - Державки для внутренней расточки

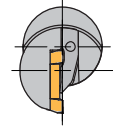
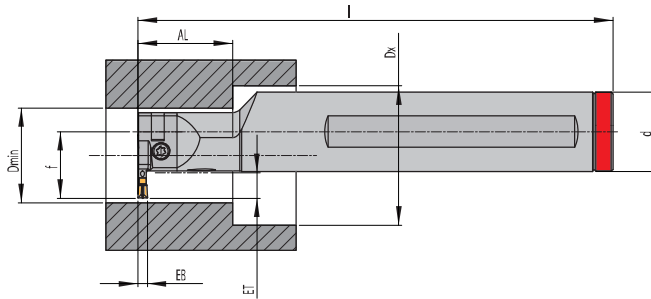
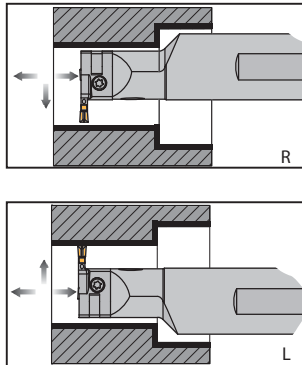

Rechte Ausführung abgebildet
 Right-hand execution shown
 Показано правостороннее исполнение

Grundhalter / Holder / Державка

Bezeichnung Designation Обозначение	D _{min}	ET	EB	AL	d	l	f	Dx	Schneideinsatz Grooving insert Пластины
SIN20M-045-20-16 R/L	16	4,5	2	20	16	110	13,0	27,5	212...
SIN20M-045-30-16 R/L	16	4,5	2	30	16	110	13,0	27,5	212...

3

Ersatzteile / Spare parts / Комплекующие

Halter Holder Державка	Schraube Screw Винт	Verschlusring Locking Ring Уплотнительное кольцо
SIN20M....-16 R/L	AS 0018	KVR16
SIN30M....-20 R/L	AS 0019	KVR20
SIN30....-20 R/L	SS 1111	KVR20
SIN30....-25 R/L	SS 1111	KVR25

Hinweis: Passende Wendschneidplatten finden Sie in unserem Katalog "Werkzeuge und Schneideinsätze zum Ein- und Abstechen".

Remark: Inserts to suit you can find in our catalogue "Tools and Inserts for grooving and parting-off".

Примечание: Сменные пластины вы можете найти в каталоге «Инструмент и сменные пластины для отрезки и обработки канавок».

SHORT-CUT®



3



Radial Stechdrehen
Radial grooving
Обработка радиальных канавок

SHORT-CUT®

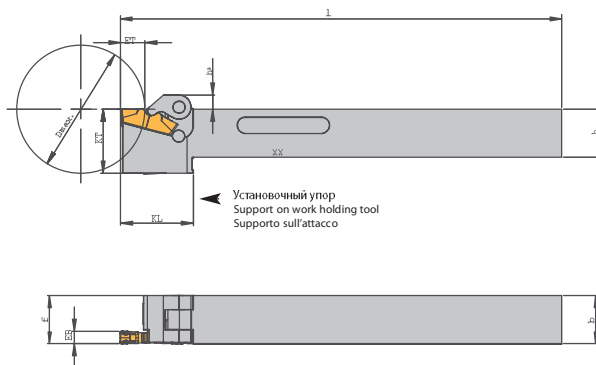
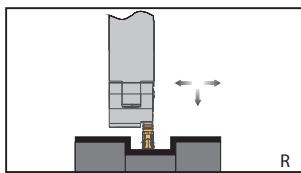

Grundhalter / Holder / Державка

Bezeichnung Designation Обозначение	h	b	l	KL	KT	f	Einstechbreite - EB Width of cut Ширина реза - EB	Einstechtiefe - ET Depth of cut Глубина реза - ET	D max.	h ₂	Schneideinsatz Grooving insert Пластины
CLCC R 1010 J02-A7-A	10	10	110	20	14,0	10	2,1	4,0	32	3,5	LOMX 12....
CLCC R 1212 J02-A7-A	12	12	110	20	16,0	12	2,1	4,0	32	3,5	LOMX 12....
CLCC R 1212 J03-A7-A	12	12	110	20	16,0	12	3,1	6,0	32	3,5	LOMX 15....
CLCC R 1616 J04-A7-A	16	16	110	-	-	16	4,1	8,0	32	3,5	LOMX 18....
CLCC R 1616 J05-A7-A	16	16	110	26	20,5	16	5,1	9,5	32	3,5	LOMX 20....

3

Ersatzteile / Spare parts / Комплекующие

Halter Holder Державка	Klemme Clamp Прижим	Klemmlagerstift Clamping pin Ось прижима	Druckfeder Compress ion spring Пружина	Schraube Screw Винт	Anlagestift Support pin Упор	Schlüssel Key Ключ
CLCCR...03-A7-A	KTC 3 R-12A	STC 5N	AD 0900	DIN912 M4x10	STC 5N	KP 1111
CLCCR...04-A7-A	KTC 4 R-16A	STC 5N	AD 0900	DIN912 M4x10	STC 5N	KP 1111

Hinweis: Passende Wendeschneidplatten finden Sie in unserem Katalog "Werkzeuge und Schneideinsätze zum Ein- und Abstechen".

Remark: Inserts to suit you can find in our catalogue "Tools and Inserts for grooving and parting-off".

Примечания: Сменные пластины вы можете найти в каталоге «Инструмент и сменные пластины для отрезки и обработки канавок».

DROP-CUT®



3



Monoblockhalter
Monobloc-holders
Моноблочные державки

DROP-CUT®

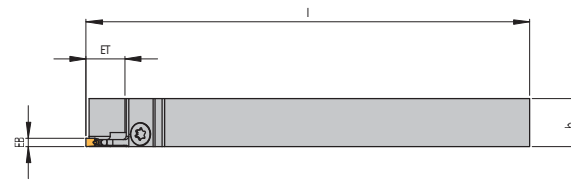
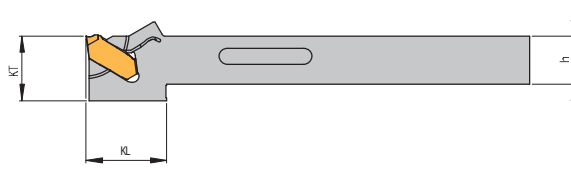
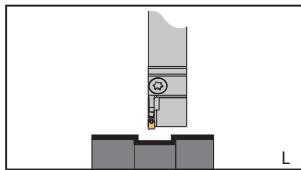
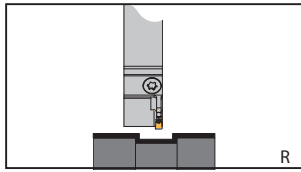

Rechte Ausführung abgebildet
Right-hand execution shown
Показано правостороннее исполнение

Grundhalter / Holder / Державка

Bezeichnung Designation Обозначение	EB	ET	D _{max}	D _R	h	b	l	KL	KT	Schneideinsatz Grooving insert Пластины
XLCO R/L 1010 J02-20	2,1	10	20	32	10	10	110	20,0	16	LO,R 1602....
XLCO R/L 1212 J02-20	2,1	10	20	32	12	12	110	20,0	16	LO,R 1602....
XLCO R/L 1616 J02-20	2,1	10	20	32	16	16	110	-	-	LO,R 1602....
XLCO R/L 1616 J02-26	2,1	13	26	32	16	16	110	26,0	20	LO,R 1602....
XLCO R/L 1616 J02-32	2,1	16	32	32	16	16	110	26,0	20	LO,R 1602....
XLCO R/L 1616 J03-26	3,1	13	26	32	16	16	110	26,0	20	LO,R 1603....
XLCO R/L 1616 J03-32	3,1	16	32	32	16	16	110	26,0	20	LO,R 1603....

D_{max} = max. Stechdurchmesser bei Vollmaterial
D_{max} = max. cutting diameter with solid material
D_{max} = Максимальный размер грутка

D_R = max. Stechdurchmesser bei Rohren
D_R = maximum grooving diameter for tubes
D_R = Максимальный размер трубы

Hinweis: Grundhalter muss in axialer Richtung an der Werkzeugaufnahme anliegen!
Information: Basic holder must be adapted in axial direction on to the work holding tool
Информация: Базовый держатель должен быть вставлен относительно оси обработки!

Ersatzteile / Spare parts / Комплекующие

Halter Holder Державка	Schraube Screw ВИНТ	Schlüssel Key Ключ
XLCO R/L	AS 0006	KS 8000

Hinweis: Passende Wendeschneidplatten finden Sie in unserem Katalog "Werkzeuge und Schneideinsätze zum Ein- und Abstechen".

Remark: Inserts to suit you can find in our catalogue "Tools and Inserts for grooving and parting-off".

Примечание: Сменные пластины вы можете найти в каталоге «Инструмент и сменные пластины для резки и обработки канавок»



MICRO - Werkzeuge
MICRO tools
Микроинструмент



Innenbearbeitung ab
Internal machining from
Внутренняя обработка от



MICRO-Werkzeuge - Übersicht
 MICRO tools - Program overview
 Микроинструменты - Обзор программы

Gewindedrehen
 Threading
 Обработка резьбы

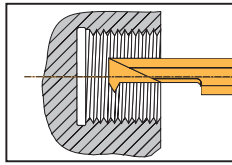

Seite 4.4 - 4.5
 Page
 Страница

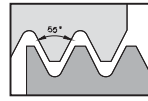

Teilprofil
 Partial profile 55°
 Неполный профиль

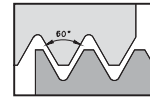

Teilprofil
 Partial profile 60°
 Неполный профиль

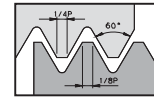

Metrisch
 Metric ISO
 Метрическая

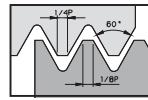

Amerikanisch
 American UN
 Американская трапецидальная

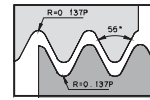

Whitworth
 Whitworth BSW
 Whitworth BSP

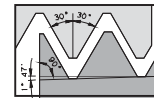

Kegeliges
 Rohrgewinde NPT
 Tapered pipe thread NPTF
 Conical thread
 Коническая резьба

Drehen
 Turning
 Растачивание

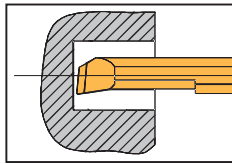

Seite 4.6
 Page
 Страница

Bohren
 Drilling
 Сверление

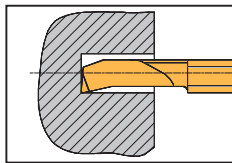

Seite 4.6
 Page
 Страница

Fasen
 Chamfering
 Обработка фасок

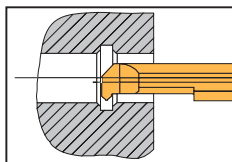

Seite 4.7
 Page
 Страница

Kopierdrehen
 Copy-turning
 Профильная обработка

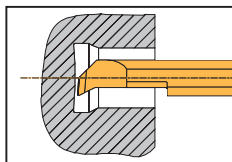

Seite 4.7
 Page
 Страница

Rückwärts - Kopierdrehen
 Solid - Back Edge
 Обрато-направленная обработка

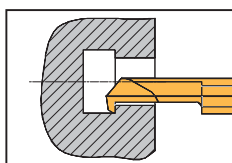

Seite 4.8
 Page
 Страница

4



Axial-Stechdrehen
 Axial grooving and copy-turning
 Обработка аксиальных канавок
 и профилей

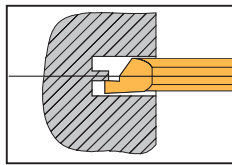

Seite
 Page 4,9
 Страница

Stechdrehen
 Grooving and copy-turning
 Обработка внутренних канавок
 и профилей

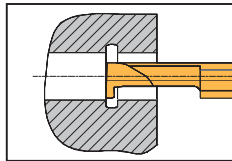

DIN 3770 Seite
 Page 4,10
 Страница
 DIN 7993 Seite
 Page 4,11
 Страница
 DIN 472 Seite
 Page 4,12
 Страница

Klemmhalter und Zubehör
 Toolholder and spare parts
 Держатели и комплектующие

Seite
 Page 4,13
 Страница

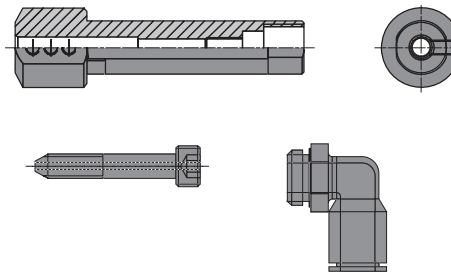

VHM - Axialstechwerkzeug
 Solid carbide face grooving tool
 Монолитный твердосплавный
 инструмент для обработки



Seite
 Page 4,14 - 4,15
 Страница

Sonderschneideinsätze

Schneideinsätze sind auf Anfrage auch in verschiedenen Sonderformen und Sonderabmessungen lieferbar.

**Пластины специального
 профиля**

По запросу возможна поставка пластин специального профиля в соответствии со спецификацией клиента

**Hinweis
 Information
 Информация**

Schneideinsätze in rechter Ausführung verfügbar. Linke Ausführung auf Anfrage.

Inserts are available in right hand execution. Left hand execution on request.

Стандартное использование пластин - правостороннее. Левостороннее исполнение поставляется по запросу



Gewindedrehen
Threading
Обработка резьбы

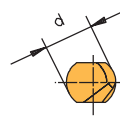
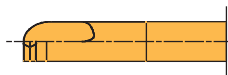
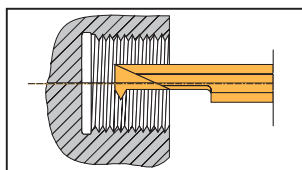

Rechte Ausführung abgebildet
Right-hand execution shown
Показано правостороннее исполнение

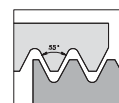
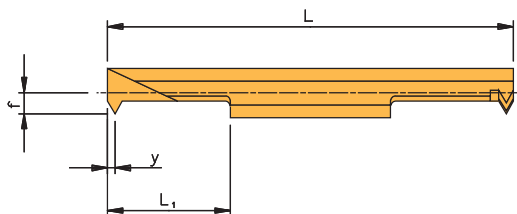
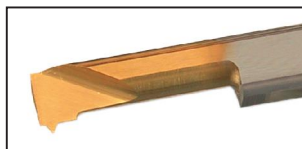

Teilprofil / Partial profile / Неполный профиль

55°

Bezeichnung Designation Обозначение	Steigung pitch Шаг [mm] [G/Zoll]	d	L ₁	L	f	y	D _{min}	Klemmhalter Toolholder Держатель	
MG-30M-F55	0,25-1,0	72-24	3	16	50	1,46	0,9	3,3	MH-16-30
MG-40M-F55	0,25-1,0	72-24	4	16	50	1,96	0,9	4,3	MH-16-40
MG-60M-A55	0,50-1,5	48-16	6	16	50	2,50	0,9	6,0	MH-16-60

Teilprofil / Partial profile / Неполный профиль

60°

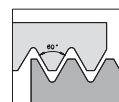

Bezeichnung Designation Обозначение	Steigung pitch Шаг [mm] [G/Zoll]	d	L ₁	L	f	y	D _{min}	Klemmhalter Toolholder Держатель	
MG-30M-F60	0,5-1,0	48-24	3	16	50	1,46	0,9	3,3	MH-16-30
MG-40M-F60	0,5-1,0	48-24	4	16	50	1,96	0,9	4,3	MH-16-40
MG-60M-A60	0,5-1,5	48-16	6	16	50	2,50	0,9	6,0	MH-16-60

Metrisch / Metric / Метрическая

ISO

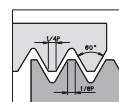

Bezeichnung Designation Обозначение	Steigung pitch Шаг [mm]	d	L ₁	L	f	y	D _{min}	Klemmhalter Toolholder Держатель
MG-30M-030 ISO	0,30	3	16	50	1,31	0,20	3,2	MH-16-30
MG-30M-040 ISO	0,40	3	16	50	1,31	0,35	3,2	MH-16-30
MG-30M-050 ISO	0,50	3	16	50	1,31	0,40	3,2	MH-16-30
MG-30M-060 ISO	0,60	3	16	50	1,34	0,60	3,2	MH-16-30
MG-30M-070 ISO	0,70	3	16	50	1,43	0,60	3,3	MH-16-30
MG-30M-075 ISO	0,75	3	16	50	1,45	0,60	3,3	MH-16-30
MG-30M-080 ISO	0,80	3	16	50	1,46	0,60	3,3	MH-16-30
MG-40M-040 ISO	0,40	4	16	50	1,65	0,35	4,0	MH-16-40
MG-40M-050 ISO	0,50	4	16	50	1,65	0,40	4,0	MH-16-40
MG-40M-060 ISO	0,60	4	16	50	1,68	0,60	4,0	MH-16-40
MG-40M-070 ISO	0,70	4	16	50	1,77	0,60	4,1	MH-16-40
MG-40M-075 ISO	0,75	4	16	50	1,81	0,60	4,2	MH-16-40
MG-40M-080 ISO	0,80	4	16	50	1,80	0,60	4,2	MH-16-40
MG-40M-100 ISO	1,00	4	16	50	1,96	0,90	4,3	MH-16-40
MG-60M-050 ISO	0,50	6	16	50	1,90	0,60	5,4	MH-16-60
MG-60M-075 ISO	0,75	6	16	50	2,06	0,60	5,6	MH-16-60
MG-60M-100 ISO	1,00	6	16	50	2,21	0,70	5,7	MH-16-60
MG-60M-125 ISO	1,25	6	16	50	2,36	0,90	5,9	MH-16-60
MG-60M-150 ISO	1,50	6	16	50	2,50	1,00	6,0	MH-16-60

Alle Abmessungen in mm
Dimensions in mm
Размеры указаны в мм



Gewindedrehen
Threading
Обработка резьбы

Amerikanisch / American / Американская трапециевидная

UN

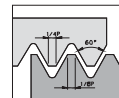

Bezeichnung Designation Обозначение	Steigung pitch Шаг [G/Zoll]	d	L ₁	L	f	y	D _{min}	Klemmhalter Toolholder Держатель
MG-30M-40 UN	40	3	16	50	1,35	0,60	3,2	MH-16-30
MG-30M-36 UN	36	3	16	50	1,46	0,60	3,2	MH-16-30
MG-30M-32 UN	32	3	16	50	1,40	0,60	3,3	MH-16-30
MG-40M-40 UN	40	4	16	50	1,65	0,60	4,0	MH-16-40
MG-40M-36 UN	36	4	16	50	1,70	0,60	4,1	MH-16-40
MG-40M-32 UN	32	4	16	50	1,76	0,60	4,1	MH-16-40
MG-40M-28 UN	28	4	16	50	1,83	0,65	4,2	MH-16-40
MG-40M-27 UN	27	4	16	50	1,85	0,75	4,2	MH-16-40
MG-40M-24 UN	24	4	16	50	1,93	0,75	4,3	MH-16-40
MG-60M-32 UN	32	6	16	50	2,01	0,60	5,5	MH-16-60
MG-60M-28 UN	28	6	16	50	2,08	0,65	5,6	MH-16-60
MG-60M-27 UN	27	6	16	50	2,10	0,75	5,6	MH-16-60
MG-60M-24 UN	24	6	16	50	2,18	0,75	5,7	MH-16-60
MG-60M-20 UN	20	6	16	50	2,30	0,90	5,8	MH-16-60
MG-60M-18 UN	18	6	16	50	2,39	1,00	5,9	MH-16-60
MG-60M-16 UN	16	6	16	50	2,50	1,05	6,0	MH-16-60

Whitworth / Whitworth / Whitworth

BSW / BSP

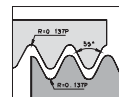

Bezeichnung Designation Обозначение	Steigung pitch Шаг [G/Zoll]	d	L ₁	L	f	y	D _{min}	Klemmhalter Toolholder Держатель
MG-40M-28 W	28	4	16	50	1,86	0,65	4,2	MH-16-40
MG-40M-26 W	26	4	16	50	1,93	0,75	4,2	MH-16-40
MG-40M-24 W	24	4	16	50	1,96	0,75	4,3	MH-16-40
MG-60M-28 W	28	6	16	50	2,50	0,65	6,0	MH-16-60
MG-60M-26 W	26	6	16	50	2,50	0,75	6,0	MH-16-60
MG-60M-24 W	24	6	16	50	2,50	0,75	6,0	MH-16-60
MG-60M-22 W	22	6	16	50	2,50	0,90	6,0	MH-16-60
MG-60M-20 W	20	6	16	50	2,50	0,90	6,0	MH-16-60
MG-60M-19 W	19	6	16	50	2,50	0,95	6,0	MH-16-60

Kegeliges Rohrgewinde / Tapered pipe thread / Коническая резьба

NPT

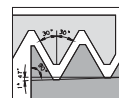

Bezeichnung Designation Обозначение	Steigung pitch Шаг [G/Zoll]	d	L ₁	L	f	y	D _{min}	Klemmhalter Toolholder Держатель
MG-60M-27 NPT	27	6	16	50	2,5	1,0	6	MH-16-60
MG-60M-18 NPT	18	6	16	50	2,5	0,8	6	MH-16-60

Kegeliges Rohrgewinde / Tapered pipe thread / Коническая резьба

NPTF

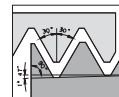

Bezeichnung Designation Обозначение	Steigung pitch Шаг [G/Zoll]	d	L ₁	L	f	y	D _{min}	Klemmhalter Toolholder Держатель
MG-60M-27 NPTF	27	6	16	50	2,5	0,8	6	MH-16-60
MG-60M-18 NPTF	18	6	16	50	2,5	1,0	6	MH-16-60



Drehen
Turning
Растачивание

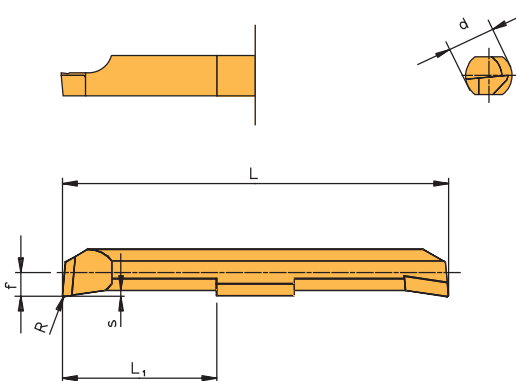
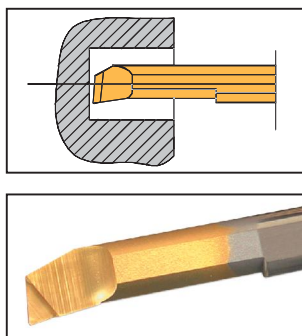

Schneideinsätze / Inserts / Вставки

Bezeichnung Designation Обозначение	d	L ₁	L	f	s	D _{min}	Klemmhalter Toolholder Держатель
MD-20K-R 0,1	3	6	36	0,22	0,4	2,2	MH-16-30
MD-20M-R 0,1	3	9	36	0,22	0,4	2,2	MH-16-30
MD-30K-R 0,2	3	9	36	1,42	0,66	3,2	MH-16-30
MD-30M-R 0,2	3	16	50	1,42	0,66	3,2	MH-16-30
MD-40K-R 0,2	4	9	36	1,92	0,66	4,2	MH-16-40
MD-40M-R 0,2	4	16	50	1,92	0,66	4,2	MH-16-40
MD-40L-R 0,2	4	21	60	1,92	0,66	4,2	MH-16-40
MD-60K-R 0,2	6	9	36	2,92	0,77	6,2	MH-16-60
MD-60M-R 0,2	6	16	50	2,92	0,77	6,2	MH-16-60
MD-60L-R 0,2	6	21	60	2,92	0,77	6,2	MH-16-60
MD-80K-R 0,2	8	12	54	3,92	0,82	8,2	MH-16-80
MD-80M-R 0,2	8	20	70	3,92	0,82	8,2	MH-16-80
MD-80L-R 0,2	8	28	86	3,92	0,82	8,2	MH-16-80
MD-100K-R 0,2	10	15	60	4,92	1,00	10,2	MH-16-100
MD-100M-R 0,2	10	25	80	4,92	1,00	10,2	MH-16-100
MD-100L-R 0,2	10	32	100	4,92	1,00	10,2	MH-16-100

4

Bohren
Drilling
Сверление

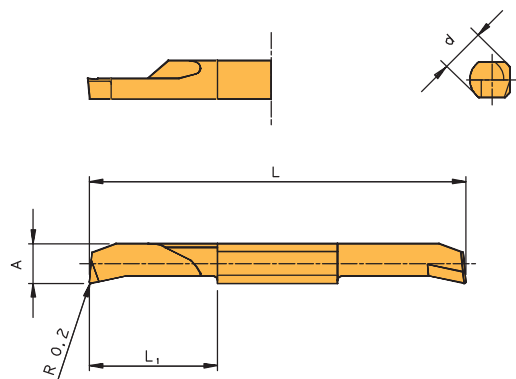
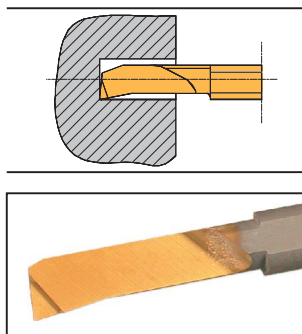

Schneideinsätze / Inserts / Вставки

Bezeichnung Designation Обозначение	d	L ₁	L	A	D _{min}	Klemmhalter Toolholder Держатель
MB-40M-R 0,2	4	16	50	3,58	3,74	MH-16-40
MB-60M-R 0,2	6	16	50	5,30	5,94	MH-16-60
MB-60L-R 0,2	6	21	60	5,30	5,94	MH-16-60
MB-80K-R 0,2	8	12	54	6,90	7,80	MH-16-80
MB-80M-R 0,2	8	20	70	6,90	7,80	MH-16-80
MB-80L-R 0,2	8	28	86	6,90	7,80	MH-16-80



Fasen
Chamfering
Обработка фасок

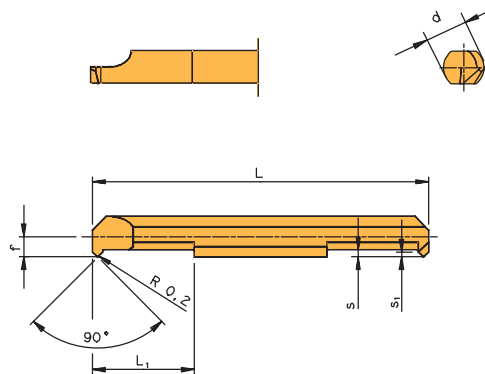
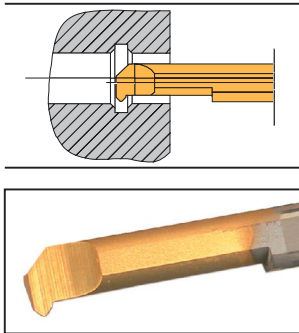

Schneideinsätze / Inserts / Вставки

Bezeichnung Designation Обозначение	d	L ₁	L	f	s ₁	s	D _{min}	Klemmhalter Toolholder Держатель
MF-40K-R 0,2	4	9	36	1,92	0,4	1,0	4,2	MH-16-40
MF-40M-R 0,2	4	16	50	1,92	0,4	1,0	4,2	MH-16-40
MF-40L-R 0,2	4	21	60	1,92	0,4	1,0	4,2	MH-16-40
MF-60K-R 0,2	6	9	36	2,92	0,7	1,2	7,0	MH-16-60
MF-60M-R 0,2	6	16	50	2,92	0,7	1,2	7,0	MH-16-60
MF-60L-R 0,2	6	21	60	2,92	0,7	1,2	7,0	MH-16-60

Kopierdrehen
Copy-turning
Профильная обработка

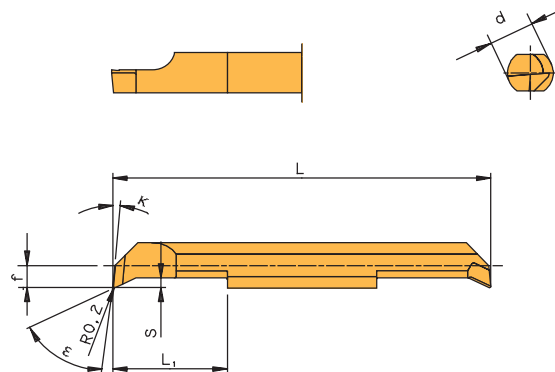
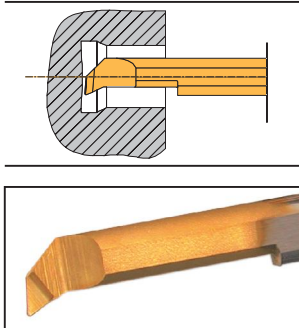

Schneideinsätze / Inserts / Вставки

Bezeichnung Designation Обозначение	d	L ₁	L	f	K	s	ε	D _{min}	Klemmhalter Toolholder Держатель
MK-40K-R 0,2	4	9	36	1,92	8°	1,0	55°	4,2	MH-16-40
MK-40M-R 0,2	4	16	50	1,92	8°	1,0	55°	4,2	MH-16-40
MK-40L-R 0,2	4	21	60	1,92	8°	1,0	55°	4,2	MH-16-40
MK-60K-R 0,2	6	9	36	2,92	8°	1,3	55°	7,0	MH-16-60
MK-60M-R 0,2	6	16	50	2,92	8°	1,3	55°	7,0	MH-16-60
MK-60L-R 0,2	6	21	60	2,92	8°	1,3	55°	7,0	MH-16-60
MKL-60K-R 0,2	6	9	36	2,92	3°	2,9	35°	6,9	MH-16-60
MKL-60M-R 0,2	6	16	50	2,92	3°	2,9	35°	6,9	MH-16-60
MKL-60L-R 0,2	6	21	60	2,92	3°	2,9	35°	6,9	MH-16-60
MKL-80K-R 0,2	8	12	54	3,92	3°	3,9	35°	8,9	MH-16-80
MKL-80M-R 0,2	8	20	70	3,92	3°	3,9	35°	8,9	MH-16-80
MKL-80L-R 0,2	8	28	86	3,92	3°	3,9	35°	8,9	MH-16-80
MKL-100K-R 0,2	10	15	60	4,92	3°	4,9	35°	10,8	MH-16-100
MKL-100M-R 0,2	10	25	80	4,92	3°	4,9	35°	10,8	MH-16-100
MKL-100L-R 0,2	10	35	100	4,92	3°	4,9	35°	10,8	MH-16-100

4



Rückwärts - Kopierdrehen
 Solid - Back Edge
 Обратноплавленная обработка

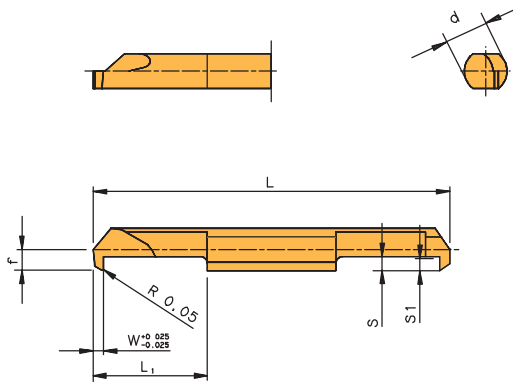
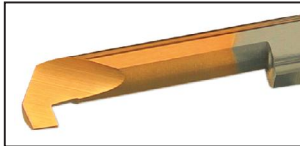
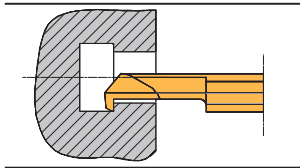

Schneideinsätze / Inserts / Вставки

Bezeichnung Designation Обозначение	d	L ₁	L	W	f	s	s ₁	D _{min}	Klemmhalter Toolholder Держатель
MR-30K-R 0,05	3	9	36	1,5	1,42	0,8	0,6	3,42	MH-16-30
MR-30M-R 0,05	3	16	50	1,5	1,42	0,8	0,6	3,42	MH-16-30
MR-40K-R 0,05	4	9	36	2,0	1,92	1,3	1,0	4,44	MH-16-40
MR-40M-R 0,05	4	16	50	2,0	1,92	1,3	1,0	4,44	MH-16-40
MR-40L-R 0,05	4	21	60	2,0	1,92	1,3	1,0	4,44	MH-16-40
MR-60K-R 0,05	6	9	36	2,0	2,92	1,9	1,6	6,44	MH-16-60
MR-60M-R 0,05	6	16	50	2,0	2,92	1,9	1,6	6,44	MH-16-60
MR-60L-R 0,05	6	21	60	2,0	2,92	1,9	1,6	6,44	MH-16-60



Axial-Stechdrehen
 Axial grooving and copy-turning
 Обработка аксиальных канавок и профилей

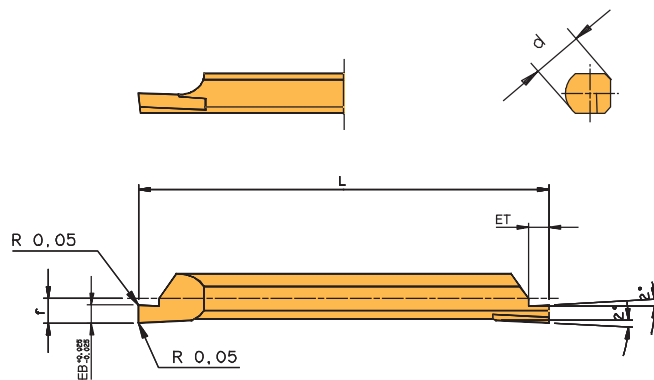
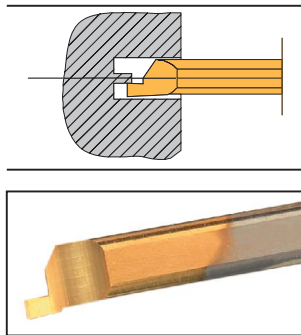

Schneideinsätze / Inserts / Вставки

Bezeichnung Designation Обозначение	d	L	f	Einstechbreite-EB Width of cut Ширина реза - EB	Einstechtiefe-ET Depth of cut Глубина реза - ET	D _{min}	Klemmhalter Toolholder Держатель
MA-40M07711-R 0,05	4	50	1,95	0,77	1,1	5,00	MH-16-40
MA-40M08712-R 0,05	4	50	1,95	0,87	1,2	5,20	MH-16-40
MA-40M09713-R 0,05	4	50	1,95	0,97	1,3	5,30	MH-16-40
MA-40M11915-R 0,05	4	50	1,95	1,19	1,5	5,50	MH-16-40
MA-40M13917-R 0,05	4	50	1,95	1,39	1,7	5,70	MH-16-40
MA-40M16920-R 0,05	4	50	1,95	1,69	2,0	6,00	MH-16-40
MA-60M07711-R 0,05	6	50	2,95	0,77	1,1	7,00	MH-16-60
MA-60M08712-R 0,05	6	50	2,95	0,87	1,2	7,20	MH-16-60
MA-60M09713-R 0,05	6	50	2,95	0,97	1,3	7,30	MH-16-60
MA-60M11915-R 0,05	6	50	2,95	1,19	1,5	7,50	MH-16-60
MA-60M13917-R 0,05	6	50	2,95	1,39	1,7	7,70	MH-16-60
MA-60M16920-R 0,05	6	50	2,95	1,69	2,0	8,00	MH-16-60
MA-60M19422-R 0,05	6	50	2,95	1,94	2,2	8,20	MH-16-60
MA-60M22425-R 0,05	6	50	2,95	2,24	2,5	8,50	MH-16-60
MA-80M11915-R 0,05	8	70	3,95	1,19	1,5	10,44	MH-16-80
MA-80M13917-R 0,05	8	70	3,95	1,39	1,7	10,44	MH-16-80
MA-80M16920-R 0,05	8	70	3,95	1,69	2,0	10,44	MH-16-80
MA-80M19422-R 0,05	8	70	3,95	1,94	2,2	10,44	MH-16-80
MA-80M22425-R 0,05	8	70	3,95	2,24	2,5	10,44	MH-16-80
MA-80M27430-R 0,05	8	70	3,95	2,74	3,0	10,44	MH-16-80
MA-100M13197-R 0,05	10	80	4,95	1,39	1,7	12,44	MH-16-100
MA-100M16920-R 0,05	10	80	4,95	1,69	2,0	12,44	MH-16-100
MA-100M19422-R 0,05	10	80	4,95	1,94	2,2	12,44	MH-16-100
MA-100M22425-R 0,05	10	80	4,95	2,24	2,5	12,44	MH-16-100
MA-100M27430-R 0,05	10	80	4,95	2,74	3,0	12,44	MH-16-100
MA-100M32435-R 0,05	10	80	4,95	3,24	3,5	12,44	MH-16-100
MA-100M42445-R 0,05	10	80	4,95	4,24	4,5	12,44	MH-16-100

4



Stechdrehen
Grooving and copy-turning
Обработка внутренних канавок и профилей

DIN 3770

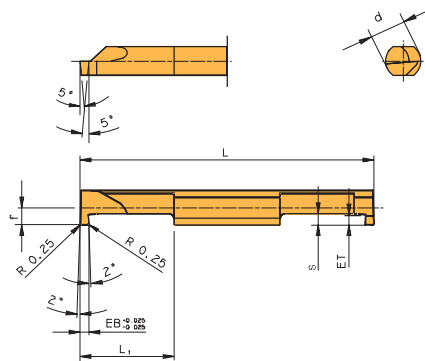
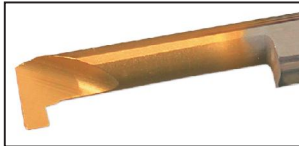
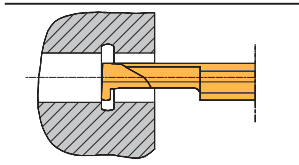

Schneideinsätze / Inserts / Вставки

Bezeichnung Designation Обозначение	d	L ₁	L	f	s	Einstechbreite-EB Width of cut Ширина реза - EB	Einstechtiefe-ET Depth of cut Глубина реза - ET	D _{min}	Klemmhalter Toolholder Держатель
M3770-60K1615-R 0,25	6	9	36	2,90	2,0	1,975	1,5	6,1	MH-16-60
M3770-60M1615-R 0,25	6	16	50	2,90	2,0	1,975	1,5	6,1	MH-16-60
M3770-60L1615-R 0,25	6	21	60	2,90	2,0	1,975	1,5	6,1	MH-16-60
M3770-60K2018-R 0,25	6	9	36	2,90	2,0	2,375	1,8	6,1	MH-16-60
M3770-60M2018-R 0,25	6	16	50	2,90	2,0	2,375	1,8	6,1	MH-16-60
M3770-60L2018-R 0,25	6	21	60	2,90	2,0	2,375	1,8	6,1	MH-16-60



Stechdrehen
Grooving and copy-turning
Обработка внутренних канавок и профилей

DIN 7993

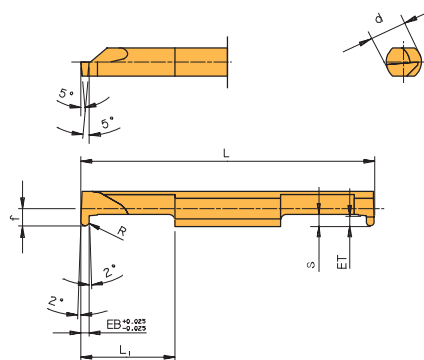
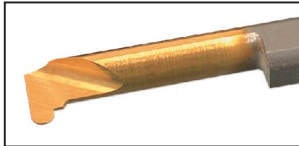
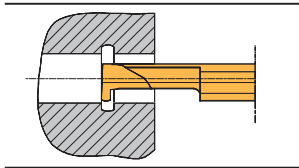

Schneideinsätze / Inserts / Вставки

Bezeichnung Designation Обозначение	d	L ₁	L	f	s	R	Einstechbreite-EB Width of cut Ширина реза -EB	Einstechtiefe-ET Depth of cut Глубина реза -ET	D _{min}	Klemmhalter Toolholder Держатель
M7993-30K0806-R 0,4	3	9	36	1,40	0,8	0,4	0,8	0,6	3,2	MH-16-30
M7993-30M0806-R 0,4	3	16	50	1,40	0,8	0,4	0,8	0,6	3,2	MH-16-30
M7993-40K0811-R 0,4	4	9	36	1,90	1,4	0,4	0,8	1,1	4,1	MH-16-40
M7993-40M0811-R 0,4	4	16	50	1,90	1,4	0,4	0,8	1,1	4,1	MH-16-40
M7993-40L0811-R 0,4	4	21	60	1,90	1,4	0,4	0,8	1,1	4,1	MH-16-40
M7993-40K1211-R 0,6	4	9	36	1,90	1,4	0,6	1,2	1,1	4,1	MH-16-40
M7993-40M1211-R 0,6	4	16	50	1,90	1,4	0,6	1,2	1,1	4,1	MH-16-40
M7993-40L1211-R 0,6	4	21	60	1,90	1,4	0,6	1,2	1,1	4,1	MH-16-40
M7993-40K1811-R 0,9	4	9	36	1,90	1,4	0,9	1,8	1,1	4,1	MH-16-40
M7993-40M1811-R 0,9	4	16	50	1,90	1,4	0,9	1,8	1,1	4,1	MH-16-40
M7993-40L1811-R 0,9	4	21	60	1,90	1,4	0,9	1,8	1,1	4,1	MH-16-40
M7993-60K1815-R 0,9	6	9	36	2,90	2,0	0,9	1,8	1,5	6,1	MH-16-60
M7993-60M1815-R 0,9	6	16	50	2,90	2,0	0,9	1,8	1,5	6,1	MH-16-60
M7993-60L1815-R 0,9	6	21	60	2,90	2,0	0,9	1,8	1,5	6,1	MH-16-60
M7993-60K2015-R 1,0	6	9	36	2,90	2,0	1,0	2,0	1,5	6,1	MH-16-60
M7993-60M2015-R 1,0	6	16	50	2,90	2,0	1,0	2,0	1,5	6,1	MH-16-60
M7993-60L2015-R 1,0	6	21	60	2,90	2,0	1,0	2,0	1,5	6,1	MH-16-60
M7993-60K2215-R 1,1	6	9	36	2,90	2,0	1,1	2,2	1,5	6,1	MH-16-60
M7993-60M2215-R 1,1	6	16	50	2,90	2,0	1,1	2,2	1,5	6,1	MH-16-60
M7993-60L2215-R 1,1	6	21	60	2,90	2,0	1,1	2,2	1,5	6,1	MH-16-60
M7993-80M1820-R 0,9	8	20	70	3,90	2,5	0,9	1,8	2,0	8,4	MH-16-80
M7993-80M2220-R 1,1	8	20	70	3,90	2,5	1,1	2,2	2,0	8,4	MH-16-80
M7993-80M2820-R 1,4	8	20	70	3,90	2,5	1,4	2,8	2,0	8,4	MH-16-80
M7993-100M2829-R 1,4	10	25	80	4,90	3,4	1,4	2,8	2,9	10,4	MH-16-100
M7993-100M3629-R 1,8	10	25	80	4,90	3,4	1,8	3,6	2,9	10,4	MH-16-100

4



Stechdrehen
Grooving and copy-turning
Обработка внутренних канавок и профилей

DIN 472

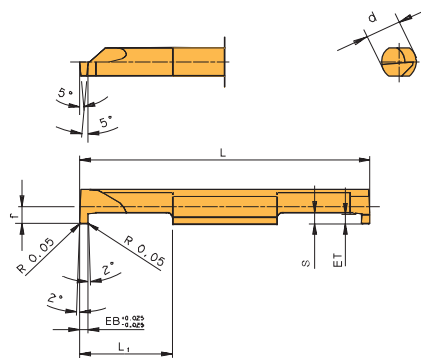
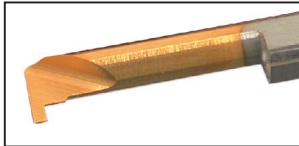
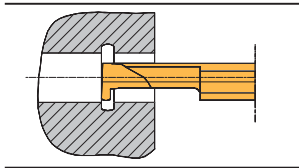

Schneideinsätze / Inserts / Вставки

Bezeichnung Designation Обозначение	d	L ₁	L	f	s	Einstechbreite-EB Width of cut Ширина реза -EB	Einstechtiefe-ET Depth of cut Глубина реза -ET	D _{min}	Klemmhalter Toolholder Держатель
M472-30K09005R 0,05	3	9	36	1,40	0,8	0,99	0,5	3,2	MH-16-30
M472-30M09005R 0,05	3	16	50	1,40	0,8	0,99	0,5	3,2	MH-16-30
M472-30K11005R 0,05	3	9	36	1,40	0,8	1,19	0,5	3,2	MH-16-30
M472-30M11005R 0,05	3	16	50	1,40	0,8	1,19	0,5	3,2	MH-16-30
M472-40K09011R 0,05	4	9	36	1,90	1,4	0,99	1,1	4,1	MH-16-40
M472-40M09011R 0,05	4	16	50	1,90	1,4	0,99	1,1	4,1	MH-16-40
M472-40L09011R 0,05	4	21	60	1,90	1,4	0,99	1,1	4,1	MH-16-40
M472-40K11011R 0,05	4	9	36	1,90	1,4	1,19	1,1	4,1	MH-16-40
M472-40M11011R 0,05	4	16	50	1,90	1,4	1,19	1,1	4,1	MH-16-40
M472-40L11011R 0,05	4	21	60	1,90	1,4	1,19	1,1	4,1	MH-16-40
M472-40K13011R 0,05	4	9	36	1,90	1,4	1,39	1,1	4,1	MH-16-40
M472-40M13011R 0,05	4	16	50	1,90	1,4	1,39	1,1	4,1	MH-16-40
M472-40L13011R 0,05	4	21	60	1,90	1,4	1,39	1,1	4,1	MH-16-40
M472-40K16011R 0,05	4	9	36	1,90	1,4	1,69	1,1	4,1	MH-16-40
M472-40M16011R 0,05	4	16	50	1,90	1,4	1,69	1,1	4,1	MH-16-40
M472-40L16011R 0,05	4	21	60	1,90	1,4	1,69	1,1	4,1	MH-16-40
M472-60K09015R 0,05	6	9	36	2,90	2,0	0,99	1,5	6,1	MH-16-60
M472-60M09015R 0,05	6	16	50	2,90	2,0	0,99	1,5	6,1	MH-16-60
M472-60L09015R 0,05	6	21	60	2,90	2,0	0,99	1,5	6,1	MH-16-60
M472-60K11015R 0,05	6	9	36	2,90	2,0	1,19	1,5	6,1	MH-16-60
M472-60M11015R 0,05	6	16	50	2,90	2,0	1,19	1,5	6,1	MH-16-60
M472-60L11015R 0,05	6	21	60	2,90	2,0	1,19	1,5	6,1	MH-16-60
M472-60K13015R 0,05	6	9	36	2,90	2,0	1,39	1,5	6,1	MH-16-60
M472-60M13015R 0,05	6	16	50	2,90	2,0	1,39	1,5	6,1	MH-16-60
M472-60L13015R 0,05	6	21	60	2,90	2,0	1,39	1,5	6,1	MH-16-60
M472-60K16015R 0,05	6	9	36	2,90	2,0	1,69	1,5	6,1	MH-16-60
M472-60M16015R 0,05	6	16	50	2,90	2,0	1,69	1,5	6,1	MH-16-60
M472-60L16015R 0,05	6	21	60	2,90	2,0	1,69	1,5	6,1	MH-16-60
M472-60K18515R 0,05	6	9	36	2,90	2,0	1,94	1,5	6,1	MH-16-60
M472-60M18515R 0,05	6	16	50	2,90	2,0	1,94	1,5	6,1	MH-16-60
M472-60L18515R 0,05	6	21	60	2,90	2,0	1,94	1,5	6,1	MH-16-60
M472-60K21515R 0,05	6	9	36	2,90	2,0	2,24	1,5	6,1	MH-16-60
M472-60M21515R 0,05	6	16	50	2,90	2,0	2,24	1,5	6,1	MH-16-60
M472-60L21515R 0,05	6	21	60	2,90	2,0	2,24	1,5	6,1	MH-16-60
M472-80M11020R 0,05	8	20	70	3,90	2,5	1,19	2,0	8,4	MH-16-80
M472-80M13020R 0,05	8	20	70	3,90	2,5	1,39	2,0	8,4	MH-16-80
M472-80M16025R 0,05	8	20	70	3,90	3,0	1,69	2,5	8,4	MH-16-80
M472-80M19025R 0,05	8	20	70	3,90	3,0	1,94	2,5	8,4	MH-16-80
M472-80M21530R 0,05	8	20	70	3,90	3,5	2,24	3,0	8,4	MH-16-80
M472-80M26535R 0,05	8	20	70	3,90	4,0	2,74	3,5	8,4	MH-16-80
M472-80M31535R 0,05	8	20	70	3,90	4,0	3,28	3,5	8,4	MH-16-80
M472-100M13035R 0,05	10	25	80	4,90	4,0	1,39	3,5	10,4	MH-16-100
M472-100M16035R 0,05	10	25	80	4,90	4,0	1,69	3,5	10,4	MH-16-100
M472-100M19035R 0,05	10	25	80	4,90	4,0	1,94	3,5	10,4	MH-16-100
M472-100M21535R 0,05	10	25	80	4,90	4,0	2,24	3,5	10,4	MH-16-100
M472-100M26535R 0,05	10	25	80	4,90	4,0	2,74	3,5	10,4	MH-16-100
M472-100M31535R 0,05	10	25	80	4,90	4,0	3,28	3,5	10,4	MH-16-100
M472-100M41535R 0,05	10	25	80	4,90	4,0	4,28	3,5	10,4	MH-16-100
M472-100M51535R 0,05	10	25	80	4,90	4,0	5,28	3,5	10,4	MH-16-100

4



Klemmhalter und Zubehör Toolholder and spare parts Держатели и комплектующие

Klemmhalter mit innerer Kühlmittelzufuhr
Toolholder with internal coolant
Держатель с системой подвода смазочно-охлаждающей жидкости

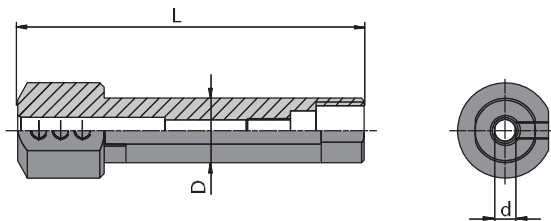

Klemmhalter werden mit Klemmschrauben, Schlüssel für Klemmschraube und Anschlag-Schraube geliefert.
Die Klemmhalter-Bezeichnung bekommt den Zusatz „Set“ (z.B. MH-16-30K Set).
Das Set beinhaltet Klemmhalter, 3 Anschlagsschrauben in unterschiedlicher Länge, Schlüssel für Klemmschraube und Schlüssel für Anschlag-Schraube.

Toolholder will be supplied with clamping screws, keys for clamping screw and fix-stop screw.
Set should be added to the toolholder designation (e.g. MH-16-30K Set). The set includes toolholder, 3 fix-stop screws in different lengths and keys for clamping screw and fix-stop screw.

Держатель поставляется в комплекте с винтами крепления, ключами для винтов крепления и ограничительного винта. Ограничительный винт в комплект поставки не входит. Заказывается отдельно. При заказе набора, вместе с обозначением держателя, пожалуйста, указывайте в заказе слово «Set» («Набор») Например (MH-16-30K Set)
Набор включает: держатель, 3 ограничительных винта различной длины, ключи для винтов крепления и ограничительных винтов.

Bezeichnung Designation Обозначение	d	D	L
MH-16-30	3	16	95
MH-16-30K	3	16	80
MH-16-30 SET	3	16	95
MH-16-30K SET	3	16	80
MH-16-40	4	16	95
MH-16-40K	4	16	80
MH-16-40 SET	4	16	95
MH-16-40K SET	4	16	80
MH-16-60	6	16	95
MH-16-60K	6	16	80
MH-16-60 SET	6	16	95
MH-16-60K SET	6	16	80
MH-16-80	8	16	93
MH-16-80 SET	8	16	93
MH-16-100	10	16	93
MH-16-100 SET	10	16	93

Anschlag-Schraube mit innerer Kühlmittelzufuhr
Fix-stop screw with internal coolant
Ограничительный винт с каналом для подвода СОЖ

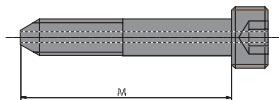

Anschlagsschraube für Einsätze / Fix-Stop / Ограничительные винты
M.. - ..L.. M.. - ..M.. M.. - ..K..

Bezeichnung Designation Обозначение			
MH-16-30	MS-37	MS-42	MS-49
MH-16-40	MS-37	MS-42	MS-49
MH-16-60	MS-37	MS-42	MS-49
MH-16-30K	MS-16	MS-21	MS-28
MH-16-40K	MS-16	MS-21	MS-28
MH-16-60K	MS-16	MS-21	MS-28
MH-16-80	MS-17	MS-25	MS-33
MH-16-100	MS-10	MS-20	MS-30

Maß „M“ ergibt sich aus der Bestellbezeichnung der Anschlagsschrauben
(MS-42: M = 42 mm)
The „M“ measurement arises out of the purchasing denotation for the limit stop screws
(MS-42: M = 42mm)
„M“ является обозначением ограничительных винтов
(MS-42: M = 42mm)

Kühlmittelanschluss
Coolant adaptor
Штуцер для подвода СОЖ

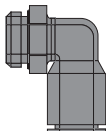

Bezeichnung Designation Обозначение
G 1/4 A

Ersatzteile / Spare parts / Комплектующие

Klemmschraube Clamping screw Винт крепления	Schlüssel für Klemmschraube Key for Clamping screw Ключ для винта крепления	Schlüssel für Anschlagsschraube Key for fix-stop screw Ключ для ограничительного винта
S 4.0	KP 3421	KP 1321



Axialstechwerkzeug
Axial face grooving tool
Обработка аксиальных канавок

VHM

Ab $D_{min} \varnothing 10$ mm und Einstechtiefen bis 40 mm / From $D_{min} \varnothing 10$ mm and grooving depths up to 40 mm /
 Обработка канавок при $D_{min}=\varnothing 10$ мм и глубиной обработки до 40 мм

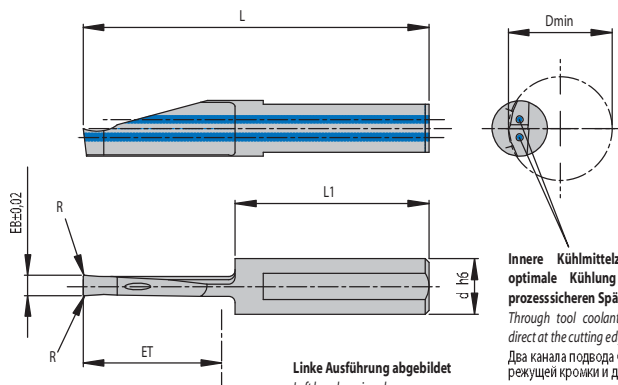
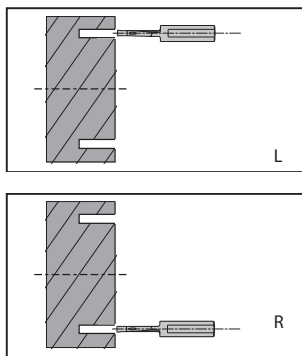

Linke Ausführung abgebildet
 Left hand version shown
 Показано левостороннее исполнение

Innere Kühlmittelzuführung für garantiert optimale Kühlung an der Schneide und Prozesssicheren Späntransport.
 Through tool coolant for both maximum coolant direct at the cutting edge and swarf evacuation.
 Два канала подвода СОЖ. Для охлаждения си смазки режущей кромки и для лучшей эвакуации стружки

Bezeichnung Designation Обозначение	EB	ET	L	L ₁	R	D _{min}	d	Sorten / Grades / Сплавы	
								beschichtet / coated / С покрытием	unbeschichtet / uncoated / Без покрытия
								AL40	AK40
SAV151006-IK-L/R	1,5	10	30	19	0,1	10	6	●	●
SAV151506-IK-L/R	1,5	15	35	19	0,1	10	6	●	●
SAV201206-IK-L/R	2,0	12	33	20	0,2	12	6	●	●
SAV202006-IK-L/R	2,0	20	40	19	0,2	12	6	●	●
SAV252008-IK-L/R	2,5	20	48	27	0,2	15	8	●	●
SAV302008-IK-L/R	3,0	20	48	27	0,2	15	8	●	●
SAV303008-IK-L/R	3,0	30	60	29	0,2	15	8	●	●
SAV403010-IK-L/R	4,0	30	60	29	0,2	30	10	●	●
SAV404010-IK-L/R	4,0	40	70	29	0,2	30	10	●	●

Beim Axialstechen ins Volle ist die komplette Stechtiefe nur im Durchmesserbereich bis 50mm erreichbar.
 When face grooving into solid the overall groove depth can only be obtained in diameter range up to 50mm.
 При обработке канавки нарезание, обработка на полную глубину возможна только в диапазоне диаметров до 50мм

4

Zubehör / Spare parts / Комплектующие

Schneideinsatz Grooving insert Вставка	Klemmhalter Toolholder Держатель
SAV...06-IK-L/R	HSAV...06
SAV...08-IK-L/R	HSAV...08
SAV...10-IK-L/R	HSAV...10

- AK40 HC - K40**
 Feinstkorn Hartmetallsorte mit guter Kantenstabilität und hoher Zuverlässigkeit zur Bearbeitung von Stahl, sämtlichen Gusswerkstoffen und NE-Metallen.
 Micrograin carbide grade with strong edge stability and high toughness for machining steel, all cast steels and none metals.
 Мелкодисперсный твердый сплав высокой прочности, обеспечивающий надежность и стабильность режущей кромки при обработке сталей, стального литья, цветных металлов и сплавов.
- AL40 HC - K40**
 PVD-Mehrlagenbeschichtung, Substrat + AlTiN
 Hochwarmfeste Beschichtung zur Bearbeitung von Stählen, austenitischen Stählen, sämtlichen Gusswerkstoffen, warmfesten Legierungen und Titanlegierungen.
 PVD multilayer coating, grade + AlTiN
 High temperature coating for machining steel, austenetic steel, all cast steels, high temperature resistant alloys and Titanium alloys.
 Сплав, многослойное покрытие PVD + AlTiN.
 Высокотемпературное покрытие для обработки сталей, аустенитных сталей и стального литья, жаропрочных сплавов и титановых сплавов.



Axialstechwerkzeug
 Axial face grooving tool
 Обработка аксиальных канавок

VHM

mit innerer Kühlmittelzufuhr
 with internal coolant
 С системой подвода СОЖ

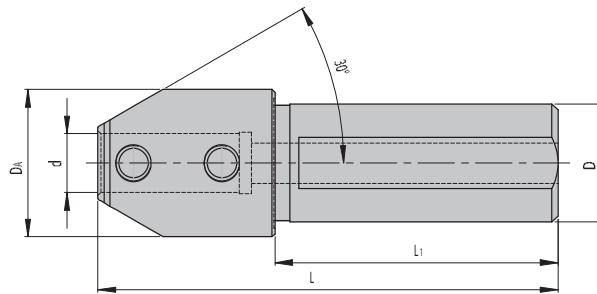

Grundhalter / Holder / Держатель

Bezeichnung Designation Обозначение	D A	D	d	L	L 1
HSAV 2006	25	20	6	78	48
HSAV 2008	25	20	8	78	48
HSAV 2010	25	20	10	78	48
HSAV 2508	30	25	8	78	48
HSAV 2510	30	25	10	78	48

Empfohlene Schnittwerte / Recommended cutting data / Рекомендуемые режимы резания

Material Material Материал	Härte Hardness Твердость (HRC)	AL40		AK40	
		Vorschub Feed rate Поддача [mm / U]	Schnittgeschwindigkeit Cutting speed Скорость резания [m/min]	Vorschub Feed rate Поддача [mm / U]	Schnittgeschwindigkeit Cutting speed Скорость резания [m/min]
Legierter Stahl, Werkzeugstahl Alloyed steel, tool steel Легированная сталь, инструментальная сталь	250	0,01 - 0,03	80 - 100	0,01 - 0,02	50 - 60
Legierter Stahl, Werkzeugstahl Alloyed steel, tool steel Легированная сталь, инструментальная сталь	300	0,01 - 0,03	70 - 90	0,01 - 0,02	50 - 60
Legierter Stahl, Werkzeugstahl Alloyed steel, tool steel Легированная сталь, инструментальная сталь	400	0,01 - 0,02	50 - 60	0,01 - 0,02	30 - 40
Nichtrostender Stahl, Titanlegierungen Stainless steel, titanium alloys Нержавеющая сталь, титановые сплавы	150-200	0,01 - 0,02	50 - 80	0,01 - 0,02	40 - 60
Guss Cast iron Чугун	200-250	0,01 - 0,03	50 - 70	0,01 - 0,02	40 - 60
Aluminiumlegierungen Aluminum alloys Алюминиевые сплавы	100	0,02 - 0,05	120 - 180	0,02 - 0,05	100 - 150
Kupferlegierungen, Messing, Nichteisenmetalle Copper alloys, Brass, non-ferrous metals Медные сплавы, Латунь, Цветные металлы	100	0,02 - 0,05	120 - 180	0,02 - 0,05	100 - 150

4



Notizen
Notes
Примечания

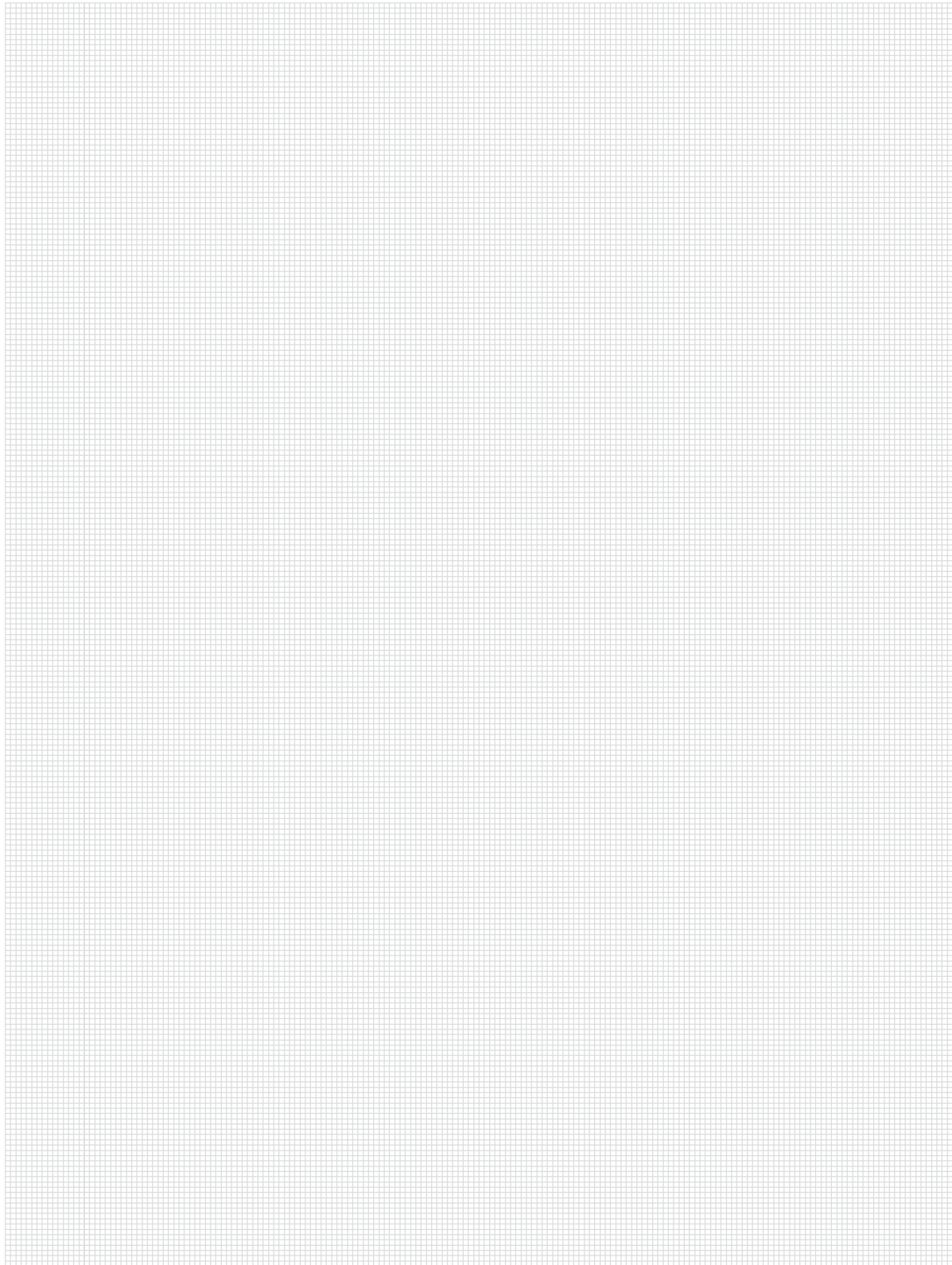

SHARK-Cut[®]



ARNO[®]
WERKZEUGE

SHARK-Cut[®]

SHARK-Cut[®]

≥ Ø 8 mm

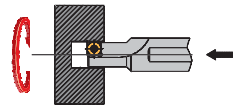

Bohren ins Volle mit ebenem
Bohrungsgrund
Drilling with flat bottom face
Сверление отверстий с плоским дном

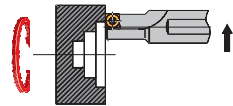

Drehen von Plankonturen
Facing operations
Обработка торцев

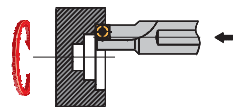

Drehen von Innenkonturen
Turning of internal profiles
Расточка внутреннего профиля

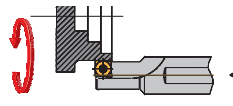

Drehen von Außenkonturen
Turning of external profiles
Токарная обработка наружных поверхностей

SHARK-Cut[®] Mini

≥ Ø 4 mm

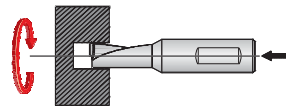
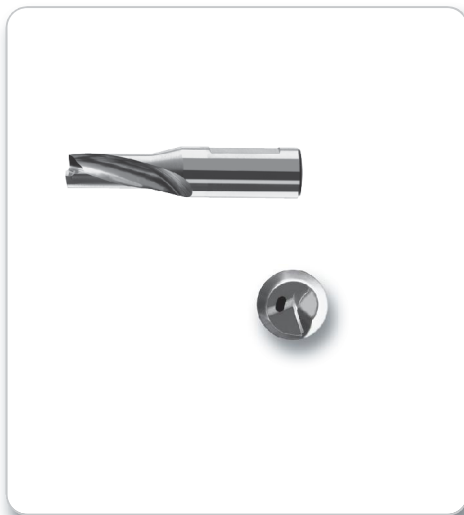

Bohren ins Volle mit ebenem
Bohrungsgrund
Drilling with flat bottom face
Сверление отверстий с плоским дном

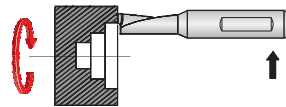

Drehen von Plankonturen
Facing operations
Обработка торцев

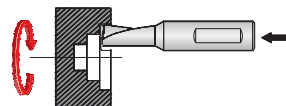

Drehen von Innenkonturen
Turning of internal profiles
Расточка внутреннего профиля

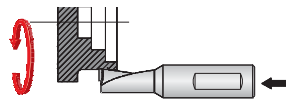

Drehen von Außenkonturen
Turning of external profiles
Токарная обработка наружных поверхностей

5



Halter

Holder
Державки

Страница

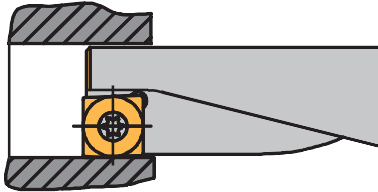

1,5 x D

5.4

2,25 x D

5.4

3 x D-Densimet

5.5

Wendeschneidplatten

Indexable inserts
Сменные пластины



LPET

5.8

LPNT

5.9

Mini-V ollhartmetallwerkzeug

Mini-solid carbide tool
Монолитный твёрдосплавный
мини - инструмент

Schneideinsatz + Adapter
Insert + adapter
Вставки + адаптер

5.10





Halter
Holder
Державки

SHARK-Cut

Bohrtiefen bis
Drilling depth up to
Глубина обработки до

1,5 x D

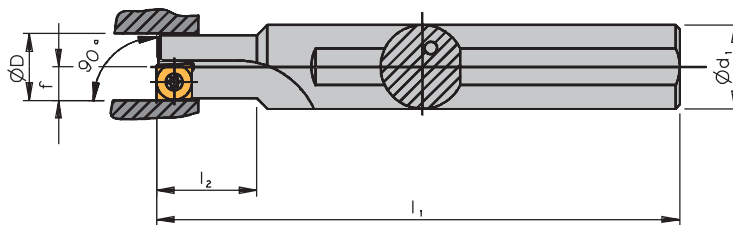

Rechte Ausführung abgebildet
Right-hand execution shown
Показано правостороннее исполнение

Grundhalter / Holder / Державки

Bezeichnung Designation Обозначение	Ø D	Ø d ₁	Ø d ₂	l ₁	l ₂	f	Wendeschneidplatte Indexable insert Пластины
SC08R/L-0012G-04 *	8	12	-	80	12,0	4,0	LPET / LPNT 0401....
SC10R/L-0015G-05	10	12	-	90	15,0	5,0	LPET / LPNT 0502....
SC12R/L-0018G-06	12	16	-	100	18,0	6,0	LPET / LPNT 0602....
SC14R/L-0021G-07	14	16	-	110	21,0	7,0	LPET / LPNT 0703....
SC16R/L-0024G-08	16	20	-	125	24,0	8,0	LPET / LPNT 0803....

* Rechter Halter - Rechte Wendeschneidplatte
Linker Halter - Linke Wendeschneidplatte.

Right-hand holder - Right-hand indexable insert
Left-hand holder - Left-hand indexable insert.

Правосторонняя державка - правосторонняя сменная пластина
Левосторонняя державка - левосторонняя сменная пластина

HINWEIS:
Halter werden mit einer Klemmschraube und
2 Ersatzschrauben geliefert, jedoch ohne Schlüssel.

INFORMATION:
Holder will be supplied with one clamping screw
and two spare screws, however without key.

Информация:
Державка поставляется в сборе с крепёжным винтом и в комплекте с двумя
запасными крепёжными винтами. Ключ в комплект поставки не входит.

Bohrtiefen bis
Drilling depth up to
Глубина обработки до

2,25 x D

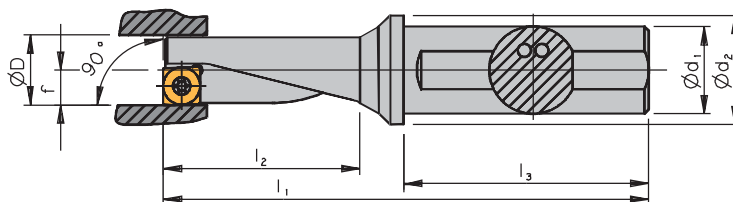

Rechte Ausführung abgebildet
Right-hand execution shown
Показано правостороннее исполнение

Grundhalter / Holder / Державки

Bezeichnung Designation Обозначение	Ø D	Ø d ₁	Ø d ₂	l ₁	l ₂	l ₃	f	Wendeschneidplatte Indexable insert Пластины
SC08R/L-0018SP-04 *	8	10	12	60,0	18,0	38	4,0	LPET / LPNT 0401....
SC10R/L-0023SP-05	10	12	16	69,5	22,5	42	5,0	LPET / LPNT 0502....
SC12R/L-0027SP-06	12	16	20	78,0	27,0	45	6,0	LPET / LPNT 0602....
SC14R/L-0032SP-07	14	16	20	83,5	31,5	45	7,0	LPET / LPNT 0703....
SC16R/L-0036SP-08	16	20	25	94,0	36,0	50	8,0	LPET / LPNT 0803....

* Rechter Halter - Rechte Wendeschneidplatte
Linker Halter - Linke Wendeschneidplatte.

Right-hand holder - Right-hand indexable insert
Left-hand holder - Left-hand indexable insert.

Правосторонняя державка - правосторонняя сменная пластина
Левосторонняя державка - левосторонняя сменная пластина

HINWEIS:
Halter werden mit einer Klemmschraube und
2 Ersatzschrauben geliefert, jedoch ohne Schlüssel.

INFORMATION:
Holder will be supplied with one clamping screw
and two spare screws, however without key.

Информация:
Державка поставляется в сборе с крепёжным винтом и в комплекте с двумя
запасными крепёжными винтами. Ключ в комплект поставки не входит.

5



Halter
Holder
Державки

SHARK-Cut °

Bohrtiefen bis
Drilling depth up to
Глубина сверления до

3 x D

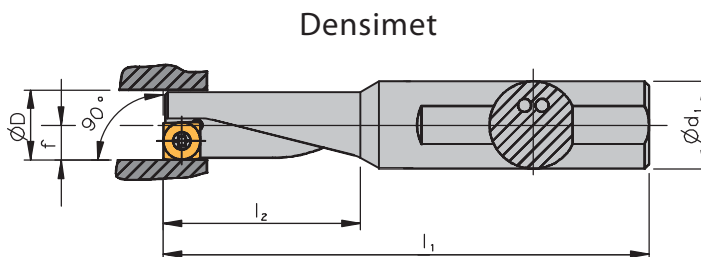

Rechte Ausführung abgebildet
Right-hand execution shown
Показано правостороннее исполнение

Grundhalter / Holder / Державки

Bezeichnung Designation Обозначение	Ø D	Ø d ₁	Ø d ₂	l ₁	l ₂	f	Wendeschneidplatte Indexable insert Пластины
SC08R/L-0024SP-04 °	8	12	-	80,0	24,0	4,0	LPET / LPNT 0401....
SC10R/L-0030SP-05	10	12	-	85,0	30,0	5,0	LPET / LPNT 0502....
SC12R/L-0036SP-06	12	16	-	95,0	36,0	6,0	LPET / LPNT 0602....
SC14R/L-0042SP-07	14	16	-	100,0	42,0	7,0	LPET / LPNT 0703....
SC16R/L-0048SP-08	16	20	-	110,0	48,0	8,0	LPET / LPNT 0803....

° Rechter Halter - Rechte Wendeschneidplatte
Linker Halter - Linke Wendeschneidplatte.

Right-hand holder - Right-hand indexable insert
Left-hand holder - Left-hand indexable insert.

Правосторонняя державка - правосторонняя сменная пластина
Левосторонняя державка - левосторонняя сменная пластина

HINWEIS:
Halter werden mit einer Klemmschraube und
2 Ersatzschrauben geliefert, jedoch ohne Schlüssel.

INFORMATION:
Holder will be supplied with one clamping screw
and two spare screws, however without key.

Информация:
Державка поставляется в сборе с крепежным винтом и в комплекте с
двумя запасными крепежными винтами. Ключ в комплект поставки не входит

Ersatzteile / Spare parts / Комплекующие

Halter Holder Державки	Schraube Screw Винт	Schlüssel Key Ключ
SC08R/L-....G-04	7815108	T 5106
SC10R/L-....G-05	7815110	T 5106
SC12R/L-....G-06	SS 5151	T 5107
SC14R/L-....G-07	SS 1751	T 5108
SC16R/L-....G-08	SS 8831	T 5108



Wendeschnidplatten
Indexable inserts
Сменные пластины

SHARK-Cut *

Hartmetall beschichtet / Coated carbide grades / Сплавы с покрытием

- AL10** HC - P10, HC - M15, HC - K10, HC - N15, HC - S10
PVD-Mehrlagenbeschichtung, Substrat + AlTiN.
Extrem verschleißfeste Sorte zur Bearbeitung von Stählen, Grauguss und NE-Metallen. Diese Sorte zeichnet sich durch hohe Beschichtungshärte und äußerst hohe Verschleißfestigkeit aus. Besonders geeignet für sehr hohe Schnittgeschwindigkeiten.
PVD-multilayer coating, substrate + AlTiN.
Extremely wear resistant grade for machining steel materials, cast iron and non ferrous products. Due to high hardness in coating, high wear-resistance can be achieved. Specially suitable for high cutting speeds.
Многослойное PVD покрытие, основа + AlTiN.
Чрезвычайно износостойкий сплав для обработки сталей, чугунов и цветных металлов. Высокая износостойкость достигается в следствии высокой твёрдости покрытия. Специально для использования на высоких скоростях резания.
- AL350** HC - P40, HC - M35
PVD-Mehrlagenbeschichtung, Substrat + TiAlN.
Hartmetallsorte für die Bearbeitung von rostfreien Stählen. Sorte ist auch geeignet für Stahlwerkstoffe im niedrigen bis mittleren Festigkeitsbereich sowie für hochwärmefeste Legierungen. Optimale Schneidkantenstabilität. Auch im mittleren und niedrigen Schnittgeschwindigkeitsbereich sehr gute Ergebnisse.
PVD-multilayer coating, substrate + TiAlN.
Grade for machining stainless steel, but can also be used for steel materials with low to medium hardness as well as for high temperature alloys. Optimum cutting edge stability. Excellent results at low to medium cutting speeds.
Многослойное PVD покрытие, основа + AlTiN.
Сплав предназначен для обработки нержавеющей сталей, но так же применяется для обработки сталей низкой и средней твёрдости, жаропрочных сплавов. Оптимальная стабильность режущей кромки. Отличные результаты на низких и средних скоростях резания.
- AM35C** HC - P35, HC - M30
CVD-Mehrlagenbeschichtung, Substrat + TiC - TiCN - TiN.
Hartmetallsorte mit hoher Zähigkeit für die Stahlbearbeitung im mittleren Schnittgeschwindigkeitsbereich.
CVD-multilayer coating, substrate + TiC - TiCN - TiN.
Carbide grade with high toughness for machining steel materials at medium cutting speeds.
Многослойное CVD покрытие, основа + TiN - TiCN - TiN.
Сплав с высокой прочностью для обработки сталей со средними скоростями резания.
- AM5035** HC-P40
PVD-Mehrlagenbeschichtung, Substrat + AlTiN
Eine verbesserte PVD-Beschichtung auf einem zähen und verschleißfesten Hartmetallsubstrat. Mit einem höheren Kobaltgehalt verfügt diese Sorte über die nötige Zähigkeit, um den Ansprüchen beim Ein- und Abstechen gerecht zu werden. AM5035 ist ausgezeichnet für die Bearbeitung der meisten Stähle, nichtrostenden Stählen und schwer zerspanbaren Stählen.
PVD-Multilayer coating, + AlTiN
An improved PVD coating on a tough and wear resistant carbide grade. Due to the higher cobalt content this grade contains all the required toughness for part-off and grooving applications. AM5035 is excellent at machining most steel, stainless steel and hard to machine materials.
Многослойное PVD покрытие, основа + AlTiN.
Высококачественное PVD покрытие на прочной и износостойкой основе. Высокое содержание кобальта обеспечивает данному сплаву прочность необходимую для отрезных операций и обработки канавок. AM5035 - отличный выбор обработки большинства сталей, нержавеющей сталей, чугуна и труднообрабатываемых материалов.
- AR26C** HC - P25, HC - K20
CVD-Mehrlagenbeschichtung, Substrat + TiN + TiCN + Al₂O₃.
Hartmetallsorte mit hoher Verschleißfestigkeit für die Bearbeitung von Guss- und Stahlwerkstoffen.
CVD-multilayer coating, substrate + TiN + TiCN + Al₂O₃.
Carbide grade with high wear resistance for machining cast iron and steel materials.
Многослойное CVD покрытие, основа + TiN + TiCN + Al₂O₃.
Сплав с высокой износостойкостью для обработки чугуна и сталей.

Hartmetall unbeschichtet / Uncoated carbide grades / Сплавы без покрытия

- AK10** HW - K10, HW - N10, HW - S10
Hartmetallsorte für die Bearbeitung von Aluminium, Aluminiumlegierungen, Nichteisenmetallen und Kunststoffen.
Die Sorte ist auch bedingt geeignet für die Bearbeitung von Gusswerkstoffen und hochwärmfesten Legierungen.
Platte ist umfängsseitig geschliffen und die Spanfläche poliert.
Grade for machining aluminium, aluminium alloys, non-ferrous metals and plastics. Grade can also be used for machining cast iron and high temperature metals. Insert is periphery ground and the chipbreaker is polished.
Сплав для обработки алюминия, алюминиевых сплавов, цветных металлов и пластиков. Может быть использован для обработки чугуна и жаропрочных сплавов. Пластина имеет шлифованные задние поверхности и полированную поверхность стружколома.
- AP40** HW - P40, HW - M35
Speziell für die Stahlbearbeitung bei Schnittgeschwindigkeiten unter 80 m/min oder bei ungünstigen Stabilitätsverhältnissen.
Special carbide grade for steel materials at cutting speeds below 80 m/min and unstable machining conditions.
Сплав специально для обработки сталей со скоростями до 80 м/мин и нестабильных условий обработки.



ISO - Anwendungsbereich
 ISO - application area
 ISO - Области применения

SHARK-Cut

ISO	Hartmetall beschichtet Carbide coated Сплавы с покрытием	Hartmetall unbeschichtet Carbide uncoated Сплавы без покрытия	Schneidstoff Cutting material Прочность / Износостойкость	Anwendung Application Подача / Скорость резания
P Stahl, Stahlguss, langspanender Temperguss Steel, cast steel, long chipping malleable iron Сталь, стальное литьё, ковкий чугун	10	AL10	Zähigkeit Toughness / Прочность Verschleißbeständigkeit Wear resistance / Износостойкость	Vorschub Feed rate / Подача Schnittgeschwindigkeit Cutting speed / Скорость резания
	20			
	30	AR26C, AM5035		
	40	AL350		
	50			
M Rostfreier Stahl, Stahlguss, Mangan- stahl, Automatenstahl Stainless steel, cast steel, manganese steel, free cutting steel Нержавеющая сталь, стальное литьё, марганцевые стали.	10	AL10	Zähigkeit Toughness / Прочность Verschleißbeständigkeit Wear resistance / Износостойкость	Vorschub Feed rate / Подача Schnittgeschwindigkeit Cutting speed / Скорость резания
	20			
	30	AM35C		
	40	AP40		
	50			
K Grauguss, Kokillenhartguss, kurzspanender Temperguss Grey cast iron, chilled hard cast iron, short chipping malleable iron Серый чугун, высокопрочный чугун, ковкий чугун, дающий сыпучую стружку.	10	AL10	Zähigkeit Toughness / Прочность Verschleißbeständigkeit Wear resistance / Износостойкость	Vorschub Feed rate / Подача Schnittgeschwindigkeit Cutting speed / Скорость резания
	20			
	30	AK10		
	40			
	50			
N Aluminium und Al - Legierungen, nichtmetallische Werkstoffe Aluminium and Al-alloys, non ferrous materials Алюминий и его сплавы, цветные металлы и сплавы.	10		Zähigkeit Toughness / Прочность Verschleißbeständigkeit Wear resistance / Износостойкость	Vorschub Feed rate / Подача Schnittgeschwindigkeit Cutting speed / Скорость резания
	20			
	30			
	40			
	50			
S Warmfeste Legierungen, Titanlegierungen High temperature resistant alloys, Titanium alloys Жаропрочные сплавы. Титановые сплавы.	10	AL10	Zähigkeit Toughness / Прочность Verschleißbeständigkeit Wear resistance / Износостойкость	Vorschub Feed rate / Подача Schnittgeschwindigkeit Cutting speed / Скорость резания
	20			
	30	AK10		
	40			
	50			
H Gehärteter Stahl, Hartguss Hardened Steel, hard cast iron Закалённые стали, материалы повышенной твёрдости.	10		Zähigkeit Toughness / Прочность Verschleißbeständigkeit Wear resistance / Износостойкость	Vorschub Feed rate / Подача Schnittgeschwindigkeit Cutting speed / Скорость резания
	20			
	30			
	40			
	50			

Hauptanwendungsbereich / Main application area / Область первичного применения

Nebenanwendungsbereich / Secondary application area / Область вторичного применения



5





Wendeschneidplatten
Indexable inserts
Сменные пластины

SHARK-Cut®

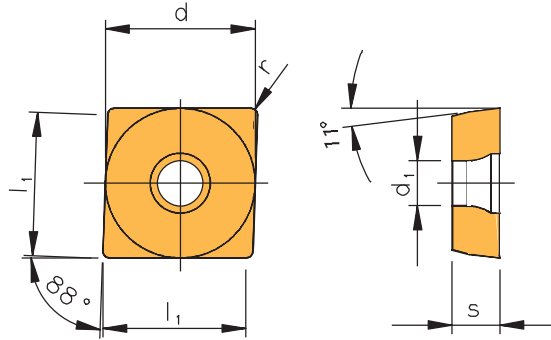
LPET...



Wendeschneidplatte / Indexable inserts / Пластины

Bezeichnung Designation Обозначение	l ₁	d ⁽²⁾	s	r	d ₁	Sorten / Grades / Сплавы					
						beschichtet / coated / С покрытием				unbeschichtet / uncoated / Без покрытия	
						AL10	AL350	AM35C	AR26C	AK10	AP40
 LPET 050204FN-ALU	5,0	5,8	2,10	0,4	2,25	●				●	
LPET 060204FN-ALU	6,0	6,5	2,38	0,4	2,50	●				●	
LPET 070304FN-ALU	7,0	7,6	3,18	0,4	2,80	●				●	
LPET 080304FN-ALU	8,0	8,5	3,18	0,4	3,40	●				●	
LPET 09T304FN-ALU	9,0	9,6	3,97	0,4	3,40	●				●	
LPET 10T304FN-ALU	10,0	10,6	3,97	0,4	4,40	●				●	
LPET 130404FN-ALU	12,5	13,5	4,76	0,4	5,30	●				●	
LPET 170508FN-ALU	16,0	17,5	5,56	0,8	5,30	●				●	
 LPET 040102FL-AWI*	4,0	4,5	1,80	0,2	2,10	●				●	
LPET 040102FR-AWI*	4,0	4,5	1,80	0,2	2,10	●				●	
LPET 040104FL-AWI	4,0	4,5	1,80	0,4	2,10	●				●	
LPET 040104FR-AWI	4,0	4,5	1,80	0,4	2,10	●				●	
LPET 050202FN-AWI*	5,0	5,8	2,10	0,2	2,25	●				●	
LPET 050204FN-AWI	5,0	5,8	2,10	0,4	2,25	●				●	
LPET 060202FN-AWI*	6,0	6,5	2,38	0,2	2,50	●				●	
LPET 060204FN-AWI	6,0	6,5	2,38	0,4	2,50	●				●	
LPET 070304FN-AWI	7,0	7,6	3,18	0,4	2,80	●				●	
LPET 080304FN-AWI	8,0	8,5	3,18	0,4	3,40	●				●	
LPET 09T304FN-AWI	9,0	9,6	3,97	0,4	3,40	●				●	
LPET 10T304FN-AWI	10,0	10,6	3,97	0,4	4,40	●				●	
LPET 10T308FN-AWI	10,0	10,6	3,97	0,8	4,40	●				●	
LPET 130304FN-AWI	12,5	13,5	4,76	0,4	5,30	●				●	
LPET 130308FN-AWI	12,5	13,5	4,76	0,8	5,30	●				●	
LPET 170508FN-AWI	16,0	17,5	5,56	0,8	5,30	●				●	
 LPET 060204EN-WI	6,0	6,5	2,38	0,4	2,50		●	●			
LPET 070304EN-WI	7,0	7,6	3,18	0,4	2,80		●	●			
LPET 080304EN-WI	8,0	8,5	3,18	0,4	3,40		●	●			
LPET 09T304EN-WI	9,0	9,6	3,97	0,4	3,40		●	●			
LPET 10T304EN-WI	10,0	10,6	3,97	0,4	4,40		●	●			
LPET 130404EN-WI	12,5	13,5	4,76	0,4	5,30		●	●			
LPET 170508EN-WI	16,0	17,5	5,56	0,8	5,30		●	●			

² Maß „d“ gemessen auf Höhe Maß „s“.

Dimension "d" measured to height "s".

Размер "d" указан на высоте "s".

5



Wendeschneidplatten
Indexable inserts
Сменные пластины

SHARK-Cut[®]

LPNT...

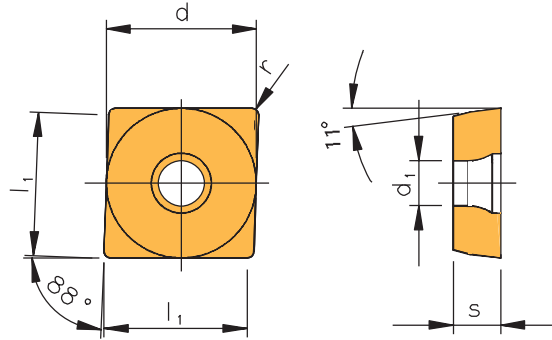

Wendeschneidplatte / Indexable inserts / Пластины

Bezeichnung Designation Обозначение	l ₁	d ^(*)	s	r	d ₁	Sorten / Grades / Сплавы						
						beschichtet / coated / С покрытием					unbeschichtet / uncoated / Без покрытия	
						AL10	AL350	AM35C	AM5035	AP26C	AK10	AP40
 LPNT 040102ER/EL* [⊙]	4,0	4,5	1,80	0,2	2,10	●	●	●	●	●		●
LPNT 040104ER/EL [⊙]	4,0	4,5	1,80	0,4	2,10				●	●		●
LPNT 050202EN*	5,0	5,8	2,10	0,2	2,25	●	●	●	●	●		●
LPNT 050204EN	5,0	5,8	2,10	0,4	2,25	●	●	●	●	●		●
LPNT 060202EN*	6,0	6,5	2,38	0,2	2,50	●	●	●	●	●		●
LPNT 060204EN	6,0	6,5	2,38	0,4	2,50	●	●	●	●	●		●
LPNT 070304EN	7,0	7,6	3,18	0,4	2,80	●	●	●	●	●		●
LPNT 080304EN	8,0	8,5	3,18	0,4	3,40	●	●	●	●	●		●

⊙ Rechter Halter - Rechte Wendeschneidplatte
Linker Halter - Linke Wendeschneidplatte.

Right-hand holder - Right-hand indexable insert
Left-hand holder - Left-hand indexable insert.

Правосторонняя державка - правосторонняя пластина
Левосторонняя державка - левосторонняя пластина

* Maß „d“ gemessen auf Höhe Maß „s“.

Dimension "d" measured to height "s".

Размер "d" указан на высоте "s".



SHARK-Cut [®] Mini

Vollhartmetall-Schneideinsatz
mit innerer Kühlmittelzufuhr
Solid carbide insert
with internal cooling supply
Монолитная твёрдосплавная
вставка с внутренним подводом СОЖ

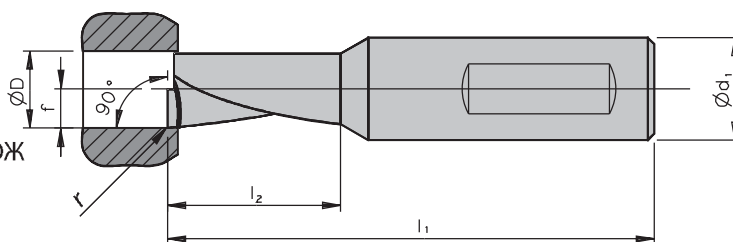
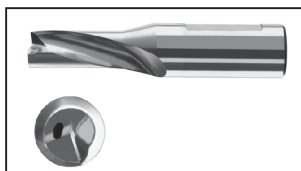

Rechte Ausführung abgebildet
Right-hand execution shown
Показано правостороннее исполнение

Grundhalter / Holder / Вставки

Bezeichnung Designation Обозначение	Ø D	Ø d ₁	l ₁	l ₂	f	r	Sorten / Grades / Сплав			
							beschichtet / coated / С покрытием		unbeschichtet / uncoated / Без покрытия	
							AL350	AM35C	AK10	AP40
SC 04 R/L -009SP	4	6	35	9,00	2,0	0,2	●			
SC 04 R/L -009SP-ALU	4	6	35	9,00	2,0	0,2			●	
SC 04 R/L -016SP	4	6	41	16,00	2,0	0,2	●			
SC 04 R/L -016SP-ALU	4	6	41	16,00	2,0	0,2			●	
SC 05 R/L -011SP	5	6	37	11,25	2,5	0,2	●			
SC 05 R/L -011SP-ALU	5	6	37	11,25	2,5	0,2			●	
SC 05 R/L -020SP	5	6	45	20,00	2,5	0,2	●			
SC 05 R/L -020SP-ALU	5	6	45	20,00	2,5	0,2			●	
SC 06 R/L -013SP	6	8	38	13,50	3,0	0,2	●			
SC 06 R/L -013SP-ALU	6	8	38	13,50	3,0	0,2			●	
SC 06 R/L -024SP	6	8	49	24,00	3,0	0,2	●			
SC 06 R/L -024SP-ALU	6	8	49	24,00	3,0	0,2			●	
SC 07 R/L -015SP	7	8	42	15,75	3,5	0,2	●			
SC 07 R/L -015SP-ALU	7	8	42	15,75	3,5	0,2			●	
SC 07 R/L -028SP	7	8	53	28,00	3,5	0,2	●			
SC 07 R/L -028SP-ALU	7	8	53	28,00	3,5	0,2			●	
SC 08 R/L -018SP	8	8	45	18,00	4,0	0,2	●			
SC 08 R/L -018SP-ALU	8	8	45	18,00	4,0	0,2			●	
SC 08 R/L -032SP	8	8	57	32,00	4,0	0,2	●			
SC 08 R/L -032SP-ALU	8	8	57	32,00	4,0	0,2			●	

Adapter
Adapter
Адаптор

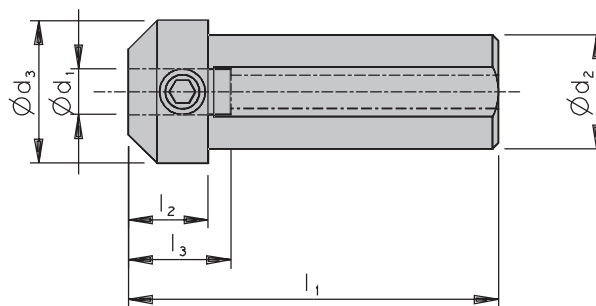
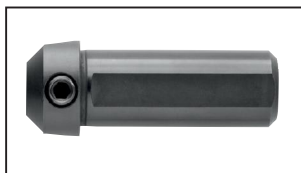

Grundhalter / Holder / Адаптеры

Bezeichnung Designation Обозначение	Ø d ₁	Ø d ₂	Ø d ₃	l ₁	l ₂	l ₃	Klemmschraube Clamping screw Крепежный винт
SC AD20-06	6	20	25	65	14	18	7897989
SC AD20-08	8	20	25	65	14	18	7897989

Informationen
Information
Информация



Drehen - Hartmetall / Hartmetall - hochpositiv, beschichtet

ISO	Werkstoff		Zugfestigkeit [N/mm ²]	Schnittgeschwindigkeit Vc [m/min]												
				AK2010	AM2030	AM2035	AM5020	AM5025	AP2015	AP2025	AP2030	AP2035	AL355	AM15C	AM25C	
P	Unlegierter Stahl und Stahlguss	ca. 0,15% C	350	-	170-220	180-230	180-230	180-230	250-300	190-240	190-240	180-230	-	220-320	150-260	
		ca. 0,45% C	650	-	160-180	170-190	170-190	170-190	220-250	170-200	170-200	170-190	-	180-250	140-210	
		ca. 0,75% C	1000	-	120-140	130-150	130-150	130-150	180-250	130-160	130-160	130-150	-	140-200	120-180	
	Niedrig legierter Stahl und Stahlguss		600	-	160-180	170-190	170-190	170-190	250-280	170-200	170-200	170-190	-	180-250	140-210	
			900	-	80-140	90-150	90-150	90-150	170-220	100-160	100-160	90-150	-	160-220	130-190	
			1200	-	60-120	70-130	70-130	70-130	150-200	80-140	80-140	70-130	-	140-200	120-180	
Hochlegierter Stahl und hochlegierter Werkzeugstahl und Stahlguss	geglüht	700	-	110-190	120-200	120-200	120-200	170-220	130-170	130-170	120-200	-	140-230	120-200		
	gehärtet und angelassen	1100	-	40-90	50-100	50-100	50-100	120-180	80-130	80-130	50-100	-	110-200	100-160		
Nichtrostender Stahl und Stahlguss	ferritisch / martensitisch, geglüht	700	-	130-170	140-180	140-180	140-180	-	130-180	130-180	140-180	-	170-260	140-240		
	martensitisch, vergütet	1000	-	100-150	110-140	110-140	110-140	150-230	110-160	110-160	110-160	-	110-200	110-200		
M	Nichtrostender Stahl und Stahlguss	austenitisch und austenitisch / ferritisch, abgeschreckt	450-600	-	100-180	100-180	120-200	120-200	-	100-170	100-170	110-190	120-180	210-250	100-170	
			600-900	-	70-140	70-140	90-160	90-160	-	-	-	80-150	-	100-170	80-150	
K	Grauguss	perlitisch, ferritisch	500-700	250-450	-	-	-	120-160	150-220	130-200	130-200	-	-	210-250	170-230	
		perlitisch, martensitisch	700-850	220-350	-	-	-	90-130	130-220	120-180	120-180	-	-	90-130	90-120	
			800-1100	-	-	-	-	-	-	-	-	-	-	-	90-130	90-120
	Gusseisen mit Kugelgraphit	ferritisch	550	220-380	-	-	-	120-160	200-360	120-170	120-170	-	-	210-250	170-230	
perlitisch		800	200-350	-	-	-	120-180	160-220	120-190	120-190	-	-	90-130	90-120		
Temperguss	ferritisch	450	200-400	-	-	-	140-220	180-350	150-230	150-230	-	-	210-250	170-230		
	perlitisch	750	180-320	-	-	-	110-160	160-260	120-170	120-170	-	-	90-130	90-120		
N	Aluminium-Knetlegierungen	nicht aushärtbar	200	-	-	-	-	-	-	-	-	-	-	-	-	
		aushärtbar, ausgehärtet	350	-	-	-	-	-	-	-	-	-	-	-	-	-
	Aluminium-Gusslegierungen	≤ 12% Si, ausgehärtet	250	-	-	-	-	-	-	-	-	-	-	-	-	-
		≤ 12% Si, aushärtbar, ausgehärtet	300	-	-	-	-	-	-	-	-	-	-	-	-	-
		≤ 12% Si, nicht aushärtbar	450	-	-	-	-	-	-	-	-	-	-	-	-	-
Kupfer und Kupferlegierungen (Bronze / Messing)	Automatenlegierung, Pb > 1%	400	-	-	-	-	-	-	-	-	-	-	-	-	-	
	Messing, Rotguss	300	-	-	-	-	-	-	-	-	-	-	-	-	-	
	Aluminiumbronze	500	-	-	-	-	-	-	-	-	-	-	-	-	-	
	Kupfer und Elektrolytkupfer	200	-	-	-	-	-	-	-	-	-	-	-	-	-	
Nichtmetallische Werkstoffe	Duroplaste		-	-	-	-	-	-	-	-	-	-	-	-	-	
	Faserverstärkte Kunststoffe		-	-	-	-	-	-	-	-	-	-	-	-	-	
	Hartgummi		-	-	-	-	-	-	-	-	-	-	-	-	-	
S	Warmfeste Legierungen	Fe-Basis geglüht	700	-	20-40	20-40	-	20-50	-	20-40	-	20-40	-	-	-	
		ausgehärtet	950	-	15-35	15-35	-	20-50	-	15-35	-	15-35	-	-	-	
		Ni- oder geglüht	800	-	8-25	8-25	-	15-40	20-40	10-30	-	8-25	-	-	-	
		Co-Basis gegossen	1100	-	4-15	4-15	-	10-25	20-30	5-18	-	4-15	-	-	-	
	ausgehärtet	1200	-	4-15	4-15	-	20-35	20-30	5-18	-	4-15	-	-	-		
	Titanlegierungen	Rein-Titan	500-700	-	80-130	80-130	-	80-140	-	80-130	-	80-130	-	-	-	
Alpha+Beta-Legierungen, ausgehärtet		700-1000	-	15-35	15-35	-	25-45	-	20-40	-	15-35	-	-	-		
H	Gehärteter Stahl	gehärtet und angelassen	1000-1350	-	-	-	-	-	-	-	-	-	-	-	-	
		gehärtet und angelassen	1350-1700	-	-	-	-	-	-	-	-	-	-	-	-	-
	Hartguss	gegossen	1350	-	-	-	-	-	-	-	-	-	-	-	-	-
Gehärtetes Gusseisen	gehärtet und angelassen	1900	-	-	-	-	-	-	-	-	-	-	-	-	-	

Drehen - Hartmetall / Hartmetall - hochpositiv, beschichtet

ISO	Werkstoff		Zugfestigkeit [N/mm²]	Schnittgeschwindigkeit Vc [m/min]												
				AM350	AM35C	AR170	AR270	AR27C	AR370	AL10	AL20	AT10	AT20	PVD1	PVD2	AD2
P	Unlegierter Stahl und Stahlguss	ca. 0,15% C	350	180-230	170-240	250-300	200-260	200-270	190-240	230-320	180-280	220-320	180-280	200-290	160-250	-
		ca. 0,45% C	650	170-190	150-200	220-250	180-220	180-230	170-200	180-290	160-250	180-290	160-250	160-260	140-220	-
		ca. 0,75% C	1000	100-140	80-150	150-220	120-180	120-180	100-150	150-250	120-220	150-250	120-220	130-230	110-180	-
	Niedrig legierter Stahl und Stahlguss		600	170-190	150-200	250-260	180-220	210-260	170-200	180-280	160-250	180-280	160-250	160-250	140-220	-
			900	90-150	80-160	170-220	120-180	120-190	100-160	170-250	140-230	170-250	140-230	150-230	130-200	-
		1200	70-130	60-140	150-200	120-150	120-160	80-140	150-220	120-200	150-220	120-200	130-200	110-190	-	
Hochlegierter Stahl und hochlegierter Werkzeugstahl und Stahlguss	geglüht	700	120-200	110-170	170-220	140-180	140-200	130-170	-	-	-	-	-	-	-	
	gehärtet und angelassen	1100	50-100	60-130	120-180	100-150	100-160	80-130	-	-	-	-	-	-	-	
Nichtrostender Stahl und Stahlguss	ferritisch / martensitisch, geglüht	700	140-180	110-180	-	170-220	170-230	130-180	170-290	160-280	170-290	160-280	150-260	130-220	-	
	martensitisch, vergütet	1000	110-160	90-160	150-230	130-180	130-190	110-160	140-280	130-280	140-280	130-280	120-250	110-200	-	
M	Nichtrostender Stahl und Stahlguss	austenitisch und austenitisch / ferritisch, abgeschreckt	450-600	120-190	100-170	150-220	150-200	150-220	100-170	140-280	140-240	140-280	140-240	120-250	120-200	-
			600-900	80-150	-	-	-	-	-	-	-	-	-	-	-	-
K	Grauguss	perlitisches, ferritisches	500-700	-	-	150-220	-	120-180	-	180-300	160-270	180-300	160-270	160-270	-	
		perlitisches, martensitisches	700-850	-	-	130-220	-	120-180	-	160-280	140-250	160-280	140-250	140-250	-	
			800-1100	-	-	100-180	-	100-150	-	120-240	110-220	120-240	110-220	110-220	-	
	Gusseisen mit Kugelgraphit	ferritisch	550	-	-	200-360	120-160	120-170	-	140-230	130-210	140-230	130-210	120-210	-	
perlitisches		800	-	-	160-220	120-180	120-190	-	120-170	110-150	120-170	110-150	110-150	-		
Temperguss	ferritisch	450	-	-	180-350	-	150-230	-	150-210	130-200	150-210	130-200	130-180	-		
	perlitisches	750	-	-	160-260	-	120-170	-	150-210	130-200	150-210	130-200	130-180	-		
N	Aluminium-Knetlegierungen	nicht aushärtbar	200	-	-	-	-	-	-	-	850-1300	850-1300	750-1200	750-1200	650-2000	
		aushärtbar, ausgehärtet	350	-	-	-	-	-	-	-	400-900	400-900	350-800	350-800	300-2000	
	Aluminium-Gusslegierungen	≤ 12% Si, ausgehärtet	250	-	-	-	-	-	-	-	260-800	260-800	230-700	230-700	650-2000	
		≤ 12% Si, aushärtbar, ausgehärtet	300	-	-	-	-	-	-	-	200-550	200-550	180-500	180-500	300-2000	
		≤ 12% Si, nicht aushärtbar	450	-	-	-	-	-	-	-	200-500	200-500	180-450	180-450	200-2000	
	Kupfer und Kupferlegierungen (Bronze / Messing)	Automatenlegierung, Pb > 1%	400	-	-	-	-	-	-	-	-	-	-	-	250-800	
Messing, Rotguss		300	-	-	-	-	-	-	-	-	-	-	-	250-800		
Aluminiumbronze		500	-	-	-	-	-	-	-	-	-	-	-	250-800		
Kupfer und Elektrolytkupfer		200	-	-	-	-	-	-	-	-	-	-	-	130-400		
Nichtmetallische Werkstoffe	Duroplaste		-	-	-	-	-	-	-	-	-	-	-	-		
	Faserverstärkte Kunststoffe		-	-	-	-	-	-	-	-	-	-	-	-		
	Hartgummi		-	-	-	-	-	-	-	-	-	-	-	-		
S	Warmfeste Legierungen	Fe-Basis geblüht	700	20-40	-	-	20-50	-	20-40	20-50	20-50	20-50	20-50	15-45	15-45	
		Fe-Basis ausgehärtet	950	15-35	-	-	20-50	-	15-35	20-50	20-50	20-50	20-50	15-45	15-45	
		Ni- oder Co-Basis geblüht	800	8-25	-	20-40	15-40	-	10-30	15-40	15-40	15-40	15-40	10-35	10-35	
		Ni- oder Co-Basis gegossen	1100	4-15	-	20-30	10-25	-	5-18	15-30	15-30	15-30	15-30	10-25	10-25	
	Ni- oder Co-Basis ausgehärtet	1200	4-15	-	20-30	20-35	-	5-18	15-30	15-30	15-30	15-30	10-25	10-25		
Titanlegierungen	Rein-Titan	500-700	-	-	-	20-60	-	-	-	-	-	-	-	-		
	Alpha+Beta-Legierungen, ausgehärtet	700-1000	-	-	-	25-45	-	-	-	-	-	-	-	-		
H	Gehärteter Stahl	gehärtet und angelassen	1000-1350	-	-	-	-	-	-	-	-	-	-	-		
		gehärtet und angelassen	1350-1700	-	-	-	-	-	-	-	-	-	-	-		
	Hartguss	gegossen	1350	-	-	-	-	-	-	-	-	-	-	-		
Gehärtetes Gusseisen	gehärtet und angelassen	1900	-	-	-	-	-	-	-	-	-	-	-			



Drehen - Hartmetall / Hartmetall - hochpositiv, unbeschichtet

ISO	Werkstoff		Zugfestigkeit [N/mm ²]	Schnittgeschwindigkeit Vc [m/min]				
				AK1010	AK1020	AP1020	AK10	AK20
P	Unlegierter Stahl und Stahlguss	ca. 0,15% C	350	-	-	110-160	-	-
		ca. 0,45% C	650	-	-	100-150	-	-
		ca. 0,75% C	1000	-	-	80-120	-	-
	Niedrig legierter Stahl und Stahlguss		600	-	-	100-150	-	-
			900	-	-	80-120	-	-
		1200	-	-	60-100	-	-	
Hochlegierter Stahl und hochlegierter Werkzeugstahl und Stahlguss	geglüht	700	-	-	-	-	-	
	gehärtet und angelassen	1100	-	-	-	-	-	
Nichtrostender Stahl und Stahlguss	ferritisch / martensitisch, geglüht	700	-	-	-	-	-	
	martensitisch, vergütet	1000	-	-	-	-	-	
M	Nichtrostender Stahl und Stahlguss	austenitisch und	450-600	-	-	80-120	-	-
		austenitisch / ferritisch, abgeschreckt	600-900	-	-	-	-	-
K	Grauguss	perlitisch, ferritisch	500-700	120-160	120-160	-	120-160	120-160
		perlitisch, martensitisch	700-850	90-140	90-140	-	90-140	90-140
			800-1100	80-140	80-140	-	80-140	80-140
	Gusseisen mit Kugelgraphit	ferritisch	550	130-170	130-170	-	130-170	130-170
		perlitisch	800	90-130	90-130	-	90-130	90-130
Temperguss	ferritisch	450	140-200	140-200	-	140-200	140-200	
	perlitisch	750	120-160	120-160	-	120-160	120-160	
N	Aluminium-Knetlegierungen	nicht aushärtbar	200	300-2500	300-2500	-	300-2500	300-2500
		aushärtbar, ausgehärtet	350	200-2000	200-2000	-	200-2000	200-2000
	Aluminium-Gusslegierungen	≤ 12% Si, ausgehärtet	250	400-1500	400-1500	-	400-1500	400-1500
		≤ 12% Si, aushärtbar, ausgehärtet	300	400-1500	400-1500	-	400-1500	400-1500
		≤ 12% Si, nicht aushärtbar	450	200-800	200-800	-	200-800	200-800
	Kupfer und Kupferlegierungen (Bronze / Messing)	Automatenlegierung, Pb > 1%	400	250-600	250-600	-	250-600	250-600
		Messing, Rotguss	300	200-600	200-600	-	200-600	200-600
		Aluminiumbronze	500	150-400	150-400	-	150-400	150-400
Kupfer und Elektrolytkupfer		200	150-300	150-300	-	150-300	150-300	
Nichtmetallische Werkstoffe	Duroplaste		80-180	80-180	-	80-180	80-180	
	Faserverstärkte Kunststoffe		60-150	60-150	-	60-150	60-150	
	Hartgummi		100-250	100-250	-	100-250	100-250	
S	Warmfeste Legierungen	Fe-Basis geblüht	700	15-40	-	-	15-40	-
		ausgehärtet	950	8-28	-	-	8-28	-
		Ni- oder geblüht	800	10-30	-	-	10-30	-
		Co-Basis gegossen	1100	8-25	-	-	8-25	-
		ausgehärtet	1200	8-25	-	-	8-25	-
	Titanlegierungen Alpha+Beta-Legierungen, ausgehärtet	Rein-Titan	500-700	60-120	60-120	-	60-120	60-120
		700-1000	30-80	30-80	-	30-80	30-180	
H	Gehärteter Stahl	gehärtet und angelassen	1000-1350	-	-	-	-	-
		gehärtet und angelassen	1350-1700	-	-	-	-	-
	Hartguss	gegossen	1350	-	-	-	-	-
Gehärtetes Gusseisen	gehärtet und angelassen	1900	-	-	-	-	-	

Drehen - Cermet / Hochharte Schneidstoffe / HSS-Schneidstoff

ISO	Werkstoff		Zugfestigkeit [N/mm ²]	Schnittgeschwindigkeit Vc [m/min]										
				AP6510	AC30C	AC90C	AP6010	ACE6	T15	AH7510	AH7520	AN8020	HSS-T1N	HSS-T1CN
P	Unlegierter Stahl und Stahlguss	ca. 0,15% C	350	100-500	170-580	160-460	100-450	100-400	100-400	-	-	-	70-100	80-110
		ca. 0,45% C	650	80-500	150-540	90-430	80-450	80-370	80-370	-	-	-	65-90	70-100
		ca. 0,75% C	1000	50-350	100-450	60-400	50-350	50-350	≥60-280	-	-	-	35-55	30-60
	Niedrig legierter Stahl und Stahlguss		600	80-500	160-580	90-350	80-450	80-300	80-300	-	-	-	30-80	35-90
			900	70-500	120-450	80-300	70-450	70-270	70-300	-	-	-	30-80	35-90
		1200	50-350	100-400	60-300	50-350	50-250	80-220	-	-	-	30-60	35-70	
Hochlegierter Stahl und hochlegierter Werkzeugstahl und Stahlguss	geglüht	700	60-320	-	90-230	60-250	80-200	60-200	-	-	-	30-60	35-70	
	gehärtet und angelassen	1100	50-180	-	60-180	50-180	50-160	60-200	-	-	-	-	-	
Nichtrostender Stahl und Stahlguss	ferritisch / martensitisch, geglüht	700	80-350	-	90-290	80-300	80-250	70-270	-	-	-	20-35	20-40	
	martensitisch, vergütet	1000	80-400	-	-	80-350	80-250	70-250	-	-	-	-	-	
M	Nichtrostender Stahl und Stahlguss	austenitisch und austenitisch / ferritisch, abgeschreckt	450-600	80-380	-	-	80-300	80-240	80-240	-	-	-	20-35	20-40
			600-900	60-350	-	-	60-300	80-240	80-200	-	-	-	-	-
K	Grauguss	perlitisch, ferritisch	500-700	100-500	140-290	-	100-300	80-300	-	900-2000	-	-	-	-
		perlitisch, martensitisch	700-850	100-380	120-260	-	100-300	80-260	-	500-900	-	-	-	-
			800-1100	100-350	90-260	-	100-300	80-240	-	300-500	-	-	-	-
	Gusseisen mit Kugelgraphit	ferritisch	550	80-350	-	80-300	100-300	80-300	80-300	-	-	-	-	-
perlitisch		800	80-350	-	80-250	100-300	80-250	80-250	-	-	-	-	-	
Temperguss	ferritisch	450	80-350	-	80-350	100-300	80-350	80-350	900-2000	-	-	-	-	
	perlitisch	750	80-350	-	60-250	100-300	60-250	60-250	500-900	-	-	-	-	
N	Aluminium-Knetlegierungen	nicht aushärtbar	200	-	-	-	-	-	-	-	-	300-3000	400-900	400-900
		aushärtbar, ausgehärtet	350	-	-	-	-	-	-	-	-	200-3000	140-240	150-250
	Aluminium-Gusslegierungen	≤ 12% Si, ausgehärtet	250	-	-	-	-	-	-	-	-	300-3000	140-240	150-250
		≤ 12% Si, aushärtbar, ausgehärtet	300	-	-	-	-	-	-	-	-	200-3000	140-240	150-250
		≤ 12% Si, nicht aushärtbar	450	-	-	-	-	-	-	-	-	200-3000	60-130	70-140
	Kupfer und Kupferlegierungen (Bronze / Messing)	Automatenlegierung, Pb > 1%	400	-	-	-	-	-	-	-	-	800-2000	90-110	100-120
		Messing, Rotguss	300	-	-	-	-	-	-	-	-	800-2000	-	-
Aluminiumbronze		500	-	-	-	-	-	-	-	-	800-2000	-	-	
Kupfer und Elektrolytkupfer		200	-	-	-	-	-	-	-	-	800-2000	110-180	120-200	
Nichtmetallische Werkstoffe	Duroplaste		-	-	-	-	-	-	-	-	-	80-140	90-150	
	Faserverstärkte Kunststoffe		-	-	-	-	-	-	-	-	400-900	-	-	
	Hartgummi		-	-	-	-	-	-	-	-	-	-	-	
S	Warmfeste Legierungen	Fe-Basis geglüht	700	-	-	-	-	-	-	300-500	-	-	10-20	10-25
		ausgehärtet	950	-	-	-	-	-	-	250-350	-	-	10-20	10-25
		Ni- oder geglüht	800	-	-	-	-	-	-	280-400	-	-	10-20	10-25
		Co-Basis gegossen	1100	-	-	-	-	-	-	200-300	-	-	-	-
		ausgehärtet	1200	-	-	-	-	-	-	200-300	-	-	-	-
	Titanlegierungen	Rein-Titan	500-700	-	-	-	-	-	-	-	-	300-500	15-30	15-35
Alpha+Beta-Legierungen, ausgehärtet		700-1000	-	-	-	-	-	-	-	-	200-350	15-30	15-35	
H	Gehärteter Stahl	gehärtet und angelassen	1000-1350	-	-	-	-	-	-	-	80-200	-	-	
		gehärtet und angelassen	1350-1700	-	-	-	-	-	-	-	50-150	-	-	
	Hartguss	gegossen	1350	-	-	-	-	-	-	60-150	-	-	-	
Gehärtetes Gusseisen	gehärtet und angelassen	1900	-	-	-	-	-	-	50-150	-	-	-		



Gewindedrehen

ISO	Werkstoff		Zugfestigkeit [N/mm ²]	Schnittgeschwindigkeit Vc [m/min]						
				AL100	AM7C	AM15C	AM35C	AK20(P)	AP30	HSS-TiN
P	Unlegierter Stahl und Stahlguss	ca. 0,15% C	350	115-190	-	140-200	80-150	-	70-100	20-50
		ca. 0,45% C	650	100-190	-	130-180	80-150	-	70-100	20-40
		ca. 0,75% C	1000	70-160	-	80-160	60-120	-	50-80	15-25
	Niedrig legierter Stahl und Stahlguss		600	85-145	-	100-155	70-130	-	70-100	20-45
			900	75-140	-	90-145	70-120	-	50-80	10-25
		1200	70-135	-	80-135	70-115	-	-	10-25	
Hochlegierter Stahl und hochlegierter Werkzeugstahl und Stahlguss	geglüht	700	70-110	-	70-115	60-110	-	10-80	-	
	gehärtet und angelassen	1100	50-100	-	50-100	50-90	-	20-55	-	
Nichtrostender Stahl und Stahlguss	ferritisch / martensitisch, geglüht	700	75-140	-	-	-	-	-	25-50	
	martensitisch, vergütet	1000	60-120	-	-	-	-	-	20-40	
M	Nichtrostender Stahl und Stahlguss	austenitisch und	450-600	70-130	70-150	70-120	-	-	-	
		austenitisch / ferritisch, abgeschreckt	600-900	40-110	40-120	40-90	-	-	-	
K	Grauguss	perlitisch, ferritisch	500-700	70-130	-	-	-	-	-	
		perlitisch, martensitisch	700-850	60-120	-	-	-	-	-	
			800-1100	60-115	-	-	-	-	-	
	Gusseisen mit Kugelgraphit	ferritisch	550	125-160	-	-	-	-	-	
perlitisch		800	90-120	-	-	-	-	-		
Temperguss	ferritisch	450	80-180	-	70-150	-	70-95	-		
	perlitisch	750	-	-	-	-	-	-		
N	Aluminium-Knetlegierungen	nicht aushärtbar	200	100-365	-	100-240	-	100-250	-	30-60
		aushärtbar, ausgehärtet	350	80-220	-	80-170	-	80-160	-	25-50
	Aluminium-Gusslegierungen	≤ 12% Si, ausgehärtet	250	200-400	-	-	-	80-120	-	25-50
		≤ 12% Si, aushärtbar, ausgehärtet	300	200-280	-	-	-	70-100	-	20-40
		≤ 12% Si, nicht aushärtbar	450	60-180	-	-	-	50-120	-	15-30
	Kupfer und Kupferlegierungen (Bronze / Messing)	Automatenlegierung, Pb > 1%	400	80-200	120-200	100-250	100-200	110-190	-	15-35
		Messing, Rotguss	300	80-225	-	80-200	-	70-170	-	15-35
Aluminiumbronze		500	-	-	-	-	-	-	15-30	
Kupfer und Elektrolytkupfer		200	120-240	120-300	100-250	100-200	110-190	-	15-35	
Nichtmetallische Werkstoffe	Duroplaste		-	-	-	-	-	-	-	
	Faserverstärkte Kunststoffe		-	-	-	-	-	-	-	
	Hartgummi		-	-	-	-	-	-	-	
S	Warmfeste Legierungen	Fe-Basis geblüht	700	45-60	-	-	-	30-50	-	-
		ausgehärtet	950	30-50	-	-	-	25-40	-	-
		Ni- oder geblüht	800	20-30	-	-	-	20-30	-	-
		Co-Basis gegossen	1100	-	-	-	-	-	-	-
	ausgehärtet	1200	15-25	-	-	-	15-25	-	-	
Titanlegierungen	Rein-Titan	500-700	140-170	-	-	-	60-100	-	-	
Alpha+Beta-Legierungen, ausgehärtet		700-1000	50-70	-	-	-	40-60	-	-	
H	Gehärteter Stahl	gehärtet und angelassen	1000-1350	-	-	-	-	-	-	
		gehärtet und angelassen	1350-1700	-	-	-	-	-	-	
	Hartguss	gegossen	1350	-	-	-	-	-	-	
Gehärtetes Gusseisen	gehärtet und angelassen	1900	45-60	-	45-60	-	-	-		

Turning - Carbide / Carbide - high positive, coated

ISO	Material		Tensile strength [N/mm ²]	Cutting speed Vc [m/min]											
				AK2010	AM2030	AM2035	AM5020	AM5025	AP2015	AP2025	AP2030	AP2035	AL355	AM15C	AM25C
P	Unalloyed steel and cast steel	ca. 0,15% C	350	-	170-220	180-230	180-230	180-230	250-300	190-240	190-240	180-230	-	220-320	150-260
		ca. 0,45% C	650	-	160-180	170-190	170-190	170-190	220-250	170-200	170-200	170-190	-	180-250	140-210
		ca. 0,75% C	1000	-	120-140	130-150	130-150	130-150	180-250	130-160	130-160	130-150	-	140-200	120-180
	Low alloyed steel and cast steel		600	-	160-180	170-190	170-190	170-190	250-280	170-200	170-200	170-190	-	180-250	140-210
		900	-	80-140	90-150	90-150	90-150	170-220	100-160	100-160	90-150	-	160-220	130-190	
		1200	-	60-120	70-130	70-130	70-130	150-200	80-140	80-140	70-130	-	140-200	120-180	
High alloyed steel, high alloyed tool-steel and cast steel	annealed	700	-	110-190	120-200	120-200	120-200	170-220	130-170	130-170	120-200	-	140-230	120-200	
	hardened and tempered	1100	-	40-90	50-100	50-100	50-100	120-180	80-130	80-130	50-100	-	110-200	100-160	
Stainless steel and cast steel	ferritic / martensitic, annealed	700	-	130-170	140-180	140-180	140-180	-	130-180	130-180	140-180	-	170-260	140-240	
	martensitic, hardened and tempered	1000	-	100-150	110-140	110-140	110-140	150-230	110-160	110-160	110-160	-	110-200	110-200	
M	Stainless steel and cast steel	austenitic and austenitic/ferritic, chilled	450-600	-	100-180	100-180	120-200	120-200	-	100-170	100-170	110-190	120-180	210-250	100-170
			600-900	-	70-140	70-140	90-160	90-160	-	-	-	80-150	-	100-170	80-150
K	Cast iron	pearlitic, ferritic	500-700	250-450	-	-	-	120-160	150-220	130-200	130-200	-	-	210-250	170-230
		pearlitic, martensitic	700-850	220-350	-	-	-	90-130	130-220	120-180	120-180	-	-	90-130	90-120
			800-1100	-	-	-	-	-	-	-	-	-	-	90-130	90-120
	Cast iron with nodular graphite	ferritic	550	220-380	-	-	-	120-160	200-360	120-170	120-170	-	-	210-250	170-230
pearlitic		800	200-350	-	-	-	120-180	160-220	120-190	120-190	-	-	90-130	90-120	
Malleable cast iron	ferritic	450	200-400	-	-	-	140-220	180-350	150-230	150-230	-	-	210-250	170-230	
	pearlitic	750	180-320	-	-	-	110-160	160-260	120-170	120-170	-	-	90-130	90-120	
N	Aluminium alloys, long chipping	not heat treatable	200	-	-	-	-	-	-	-	-	-	-	-	-
		heat treatable, heat - treated	350	-	-	-	-	-	-	-	-	-	-	-	-
	Casted aluminium alloys	≤ 12% Si, hardened	250	-	-	-	-	-	-	-	-	-	-	-	-
		≤ 12% Si, heat treatable, hardened	300	-	-	-	-	-	-	-	-	-	-	-	-
		≤ 12% Si, not heat treatable	450	-	-	-	-	-	-	-	-	-	-	-	-
	Copper and copper alloys (brass / bronze)	Lead alloys, Pb > 1%	400	-	-	-	-	-	-	-	-	-	-	-	-
Brass, bronze		300	-	-	-	-	-	-	-	-	-	-	-	-	
Aluminium bronze		500	-	-	-	-	-	-	-	-	-	-	-	-	
Copper and electrolyte copper		200	-	-	-	-	-	-	-	-	-	-	-	-	
Non ferrous materials	Duroplastics		-	-	-	-	-	-	-	-	-	-	-	-	
	Re - inforced plastics		-	-	-	-	-	-	-	-	-	-	-	-	
	Hard rubber		-	-	-	-	-	-	-	-	-	-	-	-	
S	High temperature resistant alloys	Fe-alloyed annealed	700	-	20-40	20-40	-	20-50	-	20-40	-	20-40	-	-	-
		heat - treated	950	-	15-35	15-35	-	20-50	-	15-35	-	15-35	-	-	-
		Ni- or annealed	800	-	8-25	8-25	-	15-40	20-40	10-30	-	8-25	-	-	-
		Co based casting	1100	-	4-15	4-15	-	10-25	20-30	5-18	-	4-15	-	-	-
	heat - treated	1200	-	4-15	4-15	-	20-35	20-30	5-18	-	4-15	-	-	-	
Titanium alloys, high strength	Pure titan	500-700	-	80-130	80-130	-	80-140	-	80-130	-	80-130	-	-	-	
Alpha- and Beta- alloys, hardened		700-1000	-	15-35	15-35	-	25-45	-	20-40	-	15-35	-	-	-	
H	Hardened steel	hardened and tempered	1000-1350	-	-	-	-	-	-	-	-	-	-	-	
		hardened and tempered	1350-1700	-	-	-	-	-	-	-	-	-	-	-	
	Hard cast iron	casting	1350	-	-	-	-	-	-	-	-	-	-	-	
Hardened cast iron	hardened and tempered	1900	-	-	-	-	-	-	-	-	-	-	-		



Turning - Carbide / Carbide - high positive, coated

ISO	Material		Tensile strength [N/mm ²]	Cutting speed Vc [m/min]												
				AM350	AM35C	AR170	AR270	AR27C	AR370	AL10	AL20	AT10	AT20	PVD1	PVD2	AD2
P	Unalloyed steel and cast steel	ca. 0,15% C	350	180-230	170-240	250-300	200-260	200-270	190-240	230-320	180-280	220-320	180-280	200-290	160-250	-
		ca. 0,45% C	650	170-190	150-200	220-250	180-220	180-230	170-200	180-290	160-250	180-290	160-250	160-260	140-220	-
		ca. 0,75% C	1000	100-140	80-150	150-220	120-180	120-180	100-150	150-250	120-220	150-250	120-220	130-230	110-180	-
	Low alloyed steel and cast steel		600	170-190	150-200	250-260	180-220	210-260	170-200	180-280	160-250	180-280	160-250	160-250	140-220	-
M	High alloyed steel, high alloyed tool-steel and cast steel	annealed	700	120-200	110-170	170-220	140-180	140-200	130-170	-	-	-	-	-	-	-
		hardened and tempered	1100	50-100	60-130	120-180	100-150	100-160	80-130	-	-	-	-	-	-	-
	Stainless steel and cast steel	ferritic / martensitic, annealed	700	140-180	110-180	-	170-220	170-230	130-180	170-290	160-280	170-290	160-280	150-260	130-220	-
		martensitic, hardened and tempered	1000	110-160	90-160	150-230	130-180	130-190	110-160	140-280	130-280	140-280	130-280	120-250	110-200	-
K	Stainless steel and cast steel	austenitic and austenitic/ferritic, chilled	450-600	120-190	100-170	150-220	150-200	150-220	100-170	140-280	140-240	140-280	140-240	120-250	120-200	-
			600-900	80-150	-	-	-	-	-	-	-	-	-	-	-	-
			500-700	-	-	150-220	-	120-180	-	180-300	160-270	180-300	160-270	160-270	-	-
	Cast iron	pearlitic, ferritic	700-850	-	-	130-220	-	120-180	-	160-280	140-250	160-280	140-250	140-250	-	-
pearlitic, martensitic		800-1100	-	-	100-180	-	100-150	-	120-240	110-220	120-240	110-220	110-220	-	-	
N	Cast iron with nodular graphite	ferritic	550	-	-	200-360	120-160	120-170	-	140-230	130-210	140-230	130-210	120-210	-	
		pearlitic	800	-	-	160-220	120-180	120-190	-	120-170	110-150	120-170	110-150	110-150	-	
S	Malleable cast iron	ferritic	450	-	-	180-350	-	150-230	-	150-210	130-200	150-210	130-200	130-180	-	
		pearlitic	750	-	-	160-260	-	120-170	-	150-210	130-200	150-210	130-200	130-180	-	
	Aluminium alloys, long chipping	not heat treatable	200	-	-	-	-	-	-	-	-	850-1300	850-1300	750-1200	750-1200	650-2000
		heat treatable, heat - treated	350	-	-	-	-	-	-	-	-	400-900	400-900	350-800	350-800	300-2000
H	Casted aluminium alloys	≤ 12% Si, hardened	250	-	-	-	-	-	-	-	-	260-800	260-800	230-700	230-700	650-2000
		≤ 12% Si, heat treatable, hardened	300	-	-	-	-	-	-	-	-	200-550	200-550	180-500	180-500	300-2000
		≤ 12% Si, not heat treatable	450	-	-	-	-	-	-	-	-	200-500	200-500	180-450	180-450	200-2000
	Copper and copper alloys (brass / bronze)	Lead alloys, Pb > 1%	400	-	-	-	-	-	-	-	-	-	-	-	-	250-800
Brass, bronze		300	-	-	-	-	-	-	-	-	-	-	-	-	250-800	
H	Non ferrous materials	Aluminium bronze	500	-	-	-	-	-	-	-	-	-	-	-	250-800	
		Copper and electrolyte copper	200	-	-	-	-	-	-	-	-	-	-	-	130-400	
H	High temperature resistant alloys	Duroplastics		-	-	-	-	-	-	-	-	-	-	-	-	
		Re - inforced plastics		-	-	-	-	-	-	-	-	-	-	-	-	
		Hard rubber		-	-	-	-	-	-	-	-	-	-	-	-	
		Fe-alloyed annealed	700	20-40	-	-	20-50	-	20-40	20-50	20-50	20-50	20-50	15-45	15-45	-
		heat - treated	950	15-35	-	-	20-50	-	15-35	20-50	20-50	20-50	20-50	15-45	15-45	-
H	Titanium alloys, high strength Alpha- and Beta- alloys, hardened	Ni- or annealed	800	8-25	-	20-40	15-40	-	10-30	15-40	15-40	15-40	10-35	10-35	-	
		Co based casting	1100	4-15	-	20-30	10-25	-	5-18	15-30	15-30	15-30	10-25	10-25	-	
		heat - treated	1200	4-15	-	20-30	20-35	-	5-18	15-30	15-30	15-30	10-25	10-25	-	
		Pure titan	500-700	-	-	-	20-60	-	-	-	-	-	-	-	-	
H	Hardened steel	hardened and tempered	1000-1350	-	-	-	-	-	-	-	-	-	-	-	-	
		hardened and tempered	1350-1700	-	-	-	-	-	-	-	-	-	-	-	-	
		casting	1350	-	-	-	-	-	-	-	-	-	-	-	-	
H	Hardened cast iron	hardened and tempered	1900	-	-	-	-	-	-	-	-	-	-	-	-	
		hardened and tempered		-	-	-	-	-	-	-	-	-	-	-	-	

Turning - Carbide / Carbide - high positive, uncoated

ISO	Material		Tensile strength [N/mm ²]	Cutting speed Vc [m/min]				
				AK1010	AK1020	AP1020	AK10	AK20
P	Unalloyed steel and cast steel	ca. 0,15% C	350	-	-	110-160	-	-
		ca. 0,45% C	650	-	-	100-150	-	-
		ca. 0,75% C	1000	-	-	80-120	-	-
	Low alloyed steel and cast steel		600	-	-	100-150	-	-
			900	-	-	80-120	-	-
			1200	-	-	60-100	-	-
	High alloyed steel, high alloyed tool-steel and cast steel	annealed	700	-	-	-	-	-
hardened and tempered		1100	-	-	-	-	-	
Stainless steel and cast steel	ferritic / martensitic, annealed	700	-	-	-	-	-	
	martensitic, hardened and tempered	1000	-	-	-	-	-	
M	Stainless steel and cast steel	austenitic and austenitic/ferritic, chilled	450-600	-	-	80-120	-	-
			600-900	-	-	-	-	-
K	Cast iron	pearlitic, ferritic	500-700	120-160	120-160	-	120-160	120-160
		pearlitic, martensitic	700-850	90-140	90-140	-	90-140	90-140
			800-1100	80-140	80-140	-	80-140	80-140
	Cast iron with nodular graphite	ferritic	550	130-170	130-170	-	130-170	130-170
		pearlitic	800	90-130	90-130	-	90-130	90-130
Malleable cast iron	ferritic	450	140-200	140-200	-	140-200	140-200	
	pearlitic	750	120-160	120-160	-	120-160	120-160	
N	Aluminium alloys, long chipping	not heat treatable	200	300-2500	300-2500	-	300-2500	300-2500
		heat treatable, heat - treated	350	200-2000	200-2000	-	200-2000	200-2000
	Casted aluminium alloys	≤ 12% Si, hardened	250	400-1500	400-1500	-	400-1500	400-1500
		≤ 12% Si, heat treatable, hardened	300	400-1500	400-1500	-	400-1500	400-1500
		≤ 12% Si, not heat treatable	450	200-800	200-800	-	200-800	200-800
	Copper and copper alloys (brass / bronze)	Lead alloys, Pb > 1%	400	250-600	250-600	-	250-600	250-600
		Brass, bronze	300	200-600	200-600	-	200-600	200-600
		Aluminium bronze	500	150-400	150-400	-	150-400	150-400
		Copper and electrolyte copper	200	150-300	150-300	-	150-300	150-300
Non ferrous materials	Duroplastics		80-180	80-180	-	80-180	80-180	
	Re - inforced plastics		60-150	60-150	-	60-150	60-150	
	Hard rubber		100-250	100-250	-	100-250	100-250	
S	High temperature resistant alloys	Fe-alloyed annealed	700	15-40	-	-	15-40	-
		heat - treated	950	8-28	-	-	8-28	-
		Ni- or annealed	800	10-30	-	-	10-30	-
		Co based casting	1100	8-25	-	-	8-25	-
		heat - treated	1200	8-25	-	-	8-25	-
	Titanium alloys, high strength	Pure titan	500-700	60-120	60-120	-	60-120	60-120
Alpha- and Beta- alloys, hardened		700-1000	30-80	30-80	-	30-80	30-180	
H	Hardened steel	hardened and tempered	1000-1350	-	-	-	-	-
		hardened and tempered	1350-1700	-	-	-	-	-
	Hard cast iron	casting	1350	-	-	-	-	-
Hardened cast iron	hardened and tempered	1900	-	-	-	-	-	

Turning - Cermet / Ultra-hard cutting materials / HSS cutting materials

ISO	Material		Tensile strength [N/mm ²]	Cutting speed Vc [m/min]											
				AP6510	AC30C	AC90C	AP6010	ACE6	T15	AH7510	AH7520	AN8020	HSS-T1N	HSS-T1CN	
P	Unalloyed steel and cast steel	ca. 0,15% C	350	100-500	170-580	160-460	100-450	100-400	100-400	-	-	-	70-100	80-110	
		ca. 0,45% C	650	80-500	150-540	90-430	80-450	80-370	80-370	-	-	-	65-90	70-100	
		ca. 0,75% C	1000	50-350	100-450	60-400	50-350	50-350	80-280	-	-	-	35-55	30-60	
	Low alloyed steel and cast steel		600	80-500	160-580	90-350	80-450	80-300	80-300	-	-	-	30-80	35-90	
		900	70-500	120-450	80-300	70-450	70-270	70-300	-	-	-	30-80	35-90		
		1200	50-350	100-400	60-300	50-350	50-250	80-220	-	-	-	30-60	35-70		
High alloyed steel, high alloyed tool-steel and cast steel	annealed	700	60-320	-	90-230	60-250	80-200	60-200	-	-	-	30-60	35-70		
	hardened and tempered	1100	50-180	-	60-180	50-180	50-160	60-200	-	-	-	-	-		
Stainless steel and cast steel	ferritic / martensitic, annealed	700	80-350	-	90-290	80-300	80-250	70-270	-	-	-	20-35	20-40		
	martensitic, hardened and tempered	1000	80-400	-	-	80-350	80-250	70-250	-	-	-	-	-		
M	Stainless steel and cast steel	austenitic and austenitic/ferritic, chilled	450-600	80-380	-	-	80-300	80-240	80-240	-	-	-	20-35	20-40	
			600-900	60-350	-	-	60-300	80-240	80-200	-	-	-	-	-	
K	Cast iron	pearlitic, ferritic	500-700	100-500	140-290	-	100-300	80-300	-	900-2000	-	-	-	-	
		pearlitic, martensitic	700-850	100-380	120-260	-	100-300	80-260	-	500-900	-	-	-	-	
			800-1100	100-350	90-260	-	100-300	80-240	-	300-500	-	-	-	-	
	Cast iron with nodular graphite	ferritic	550	80-350	-	80-300	100-300	80-300	80-300	-	-	-	-	-	
pearlitic		800	80-350	-	80-250	100-300	80-250	80-250	-	-	-	-	-		
Malleable cast iron	ferritic	450	80-350	-	80-350	100-300	80-350	80-350	900-2000	-	-	-	-		
	pearlitic	750	80-350	-	60-250	100-300	60-250	60-250	500-900	-	-	-	-		
N	Aluminium alloys, long chipping	not heat treatable	200	-	-	-	-	-	-	-	-	300-3000	400-900	400-900	
		heat treatable, heat - treated	350	-	-	-	-	-	-	-	-	200-3000	140-240	150-250	
	Casted aluminium alloys	≤ 12% Si, hardened	250	-	-	-	-	-	-	-	-	-	300-3000	140-240	150-250
		≤ 12% Si, heat treatable, hardened	300	-	-	-	-	-	-	-	-	-	200-3000	140-240	150-250
		≤ 12% Si, not heat treatable	450	-	-	-	-	-	-	-	-	-	200-3000	60-130	70-140
	Copper and copper alloys (brass / bronze)	Lead alloys, Pb > 1%	400	-	-	-	-	-	-	-	-	-	800-2000	90-110	100-120
		Brass, bronze	300	-	-	-	-	-	-	-	-	-	800-2000	-	-
Aluminium bronze		500	-	-	-	-	-	-	-	-	-	800-2000	-	-	
Copper and electrolyte copper		200	-	-	-	-	-	-	-	-	-	800-2000	110-180	120-200	
Non ferrous materials	Duroplastics		-	-	-	-	-	-	-	-	-	-	80-140	90-150	
	Re - inforced plastics		-	-	-	-	-	-	-	-	-	400-900	-	-	
	Hard rubber		-	-	-	-	-	-	-	-	-	-	-	-	
S	High temperature resistant alloys	Fe-alloyed annealed	700	-	-	-	-	-	-	300-500	-	-	10-20	10-25	
		heat - treated	950	-	-	-	-	-	-	250-350	-	-	10-20	10-25	
		Ni- or annealed	800	-	-	-	-	-	-	280-400	-	-	10-20	10-25	
		Co based casting	1100	-	-	-	-	-	-	200-300	-	-	-	-	
	heat - treated	1200	-	-	-	-	-	-	200-300	-	-	-	-		
Titanium alloys, high strength	Pure titan	500-700	-	-	-	-	-	-	-	-	300-500	15-30	15-35		
Alpha- and Beta- alloys, hardened		700-1000	-	-	-	-	-	-	-	-	200-350	15-30	15-35		
H	Hardened steel	hardened and tempered	1000-1350	-	-	-	-	-	-	-	80-200	-	-	-	
		hardened and tempered	1350-1700	-	-	-	-	-	-	-	50-150	-	-	-	
	Hard cast iron	casting	1350	-	-	-	-	-	-	60-150	-	-	-	-	
Hardened cast iron	hardened and tempered	1900	-	-	-	-	-	-	50-150	-	-	-	-		

Threading

ISO	Material		Tensile strength [N/mm ²]	Cutting speed Vc [m/min]						
				AL100	AM7C	AM15C	AM35C	AK20(P)	AP30	HSS-TiN
P	Unalloyed steel and cast steel	ca. 0,15% C	350	115-190	-	140-200	80-150	-	70-100	20-50
		ca. 0,45% C	650	100-190	-	130-180	80-150	-	70-100	20-40
		ca. 0,75% C	1000	70-160	-	80-160	60-120	-	50-80	15-25
	Low alloyed steel and cast steel		600	85-145	-	100-155	70-130	-	70-100	20-45
			900	75-140	-	90-145	70-120	-	50-80	10-25
			1200	70-135	-	80-135	70-115	-	-	10-25
	High alloyed steel, high alloyed tool-steel and cast steel	annealed	700	70-110	-	70-115	60-110	-	10-80	-
hardened and tempered		1100	50-100	-	50-100	50-90	-	20-55	-	
Stainless steel and cast steel	ferritic / martensitic, annealed	700	75-140	-	-	-	-	-	25-50	
	martensitic, hardened and tempered	1000	60-120	-	-	-	-	-	20-40	
M	Stainless steel and cast steel	austenitic and austenitic/ferritic, chilled	450-600	70-130	70-150	70-120	-	-	-	-
			600-900	40-110	40-120	40-90	-	-	-	-
K	Cast iron	pearlitic, ferritic	500-700	70-130	-	-	-	-	-	-
		pearlitic, martensitic	700-850	60-120	-	-	-	-	-	-
			800-1100	60-115	-	-	-	-	-	-
	Cast iron with nodular graphite	ferritic	550	125-160	-	-	-	-	-	-
pearlitic		800	90-120	-	-	-	-	-	-	
Malleable cast iron	ferritic	450	80-180	-	70-150	-	70-95	-	-	
	pearlitic	750	-	-	-	-	-	-	-	
N	Aluminium alloys, long chipping	not heat treatable	200	100-365	-	100-240	-	100-250	-	30-60
		heat treatable, heat - treated	350	80-220	-	80-170	-	80-160	-	25-50
	Casted aluminium alloys	≤ 12% Si, hardened	250	200-400	-	-	-	80-120	-	25-50
		≤ 12% Si, heat treatable, hardened	300	200-280	-	-	-	70-100	-	20-40
		≤ 12% Si, not heat treatable	450	60-180	-	-	-	50-120	-	15-30
	Copper and copper alloys (brass / bronze)	Lead alloys, Pb > 1%	400	80-200	120-200	100-250	100-200	110-190	-	15-35
		Brass, bronze	300	80-225	-	80-200	-	70-170	-	15-35
Aluminium bronze		500	-	-	-	-	-	-	15-30	
Copper and electrolyte copper		200	120-240	120-300	100-250	100-200	110-190	-	15-35	
Non ferrous materials	Duroplastics		-	-	-	-	-	-	-	
	Re - inforced plastics		-	-	-	-	-	-	-	
	Hard rubber		-	-	-	-	-	-	-	
S	High temperature resistant alloys	Fe-alloyed annealed	700	45-60	-	-	-	30-50	-	-
		heat - treated	950	30-50	-	-	-	25-40	-	-
		Ni- or annealed	800	20-30	-	-	-	20-30	-	-
		Co based casting	1100	-	-	-	-	-	-	-
	heat - treated	1200	15-25	-	-	-	15-25	-	-	
Titanium alloys, high strength	Pure titan	500-700	140-170	-	-	-	60-100	-	-	
Alpha- and Beta- alloys, hardened		700-1000	50-70	-	-	-	40-60	-	-	
H	Hardened steel	hardened and tempered	1000-1350	-	-	-	-	-	-	
		hardened and tempered	1350-1700	-	-	-	-	-	-	
	Hard cast iron	casting	1350	-	-	-	-	-	-	
Hardened cast iron	hardened and tempered	1900	45-60	-	45-60	-	-	-		





Рекомендации по выбору режимов резания

Точение - Твёрдые сплавы / Твёрдые сплавы с высокопозитивной геометрией - с покрытием

ISO	Materiale		Предел прочности (N/mm ²)	Скорость резания Vc [m/min]											
				AK2010	AM2030	AM2035	AM5020	AM5025	AP2015	AP2025	AP2030	AP2035	AL355	AM15C	AM25C
P	Нелегированная сталь и стальное литьё	с содержанием углерода до 0,15% C	350	-	170-220	180-230	180-230	180-230	250-300	190-240	190-240	180-230	-	220-320	150-260
		с содержанием углерода до 0,45% C	650	-	160-180	170-190	170-190	170-190	220-250	170-200	170-200	170-190	-	180-250	140-210
		с содержанием углерода до 0,75% C	1000	-	120-140	130-150	130-150	130-150	180-250	130-160	130-160	130-150	-	140-200	120-180
	Низколегированная сталь и стальное литьё		600	-	160-180	170-190	170-190	170-190	250-280	170-200	170-200	170-190	-	180-250	140-210
			900	-	80-140	90-150	90-150	90-150	170-220	100-160	100-160	90-150	-	160-220	130-190
			1200	-	60-120	70-130	70-130	70-130	150-200	80-140	80-140	70-130	-	140-200	120-180
	Высоколегированная сталь, высоколегированная инструментальная сталь и стальное литьё	отожжённые	700	-	110-190	120-200	120-200	120-200	170-220	130-170	130-170	120-200	-	140-230	120-200
		закалённые и термообработанные	1100	-	40-90	50-100	50-100	50-100	120-180	80-130	80-130	50-100	-	110-200	100-160
	Нержавеющая сталь и стальное литьё	ферритные/мартенситные, отожжённые	700	-	130-170	140-180	140-180	140-180	-	130-180	130-180	140-180	-	170-260	140-240
		мартенситные, закалённые и термообработанные	1000	-	100-150	110-140	110-140	110-140	150-230	110-160	110-160	110-160	-	110-200	110-200
M	Нержавеющая сталь и стальное литьё	аустенитные и ферритно-аустенитные	450-600	-	100-180	100-180	120-200	120-200	-	100-170	100-170	110-190	120-180	210-250	100-170
закалённые		600-900	-	70-140	70-140	90-160	90-160	-	-	-	80-150	-	100-170	80-150	
K	Серый чугун	перлитный, ферритный	500-700	250-450	-	-	-	120-160	150-220	130-200	130-200	-	-	210-250	170-230
		перлитный, мартенситный	700-850	220-350	-	-	-	90-130	130-220	120-180	120-180	-	-	90-130	90-120
			800-1100	-	-	-	-	-	-	-	-	-	-	90-130	90-120
	Чугун с шаровидным графитом	ферритный	550	220-380	-	-	-	120-160	200-360	120-170	120-170	-	-	210-250	170-230
перлитный		800	200-350	-	-	-	120-180	160-220	120-190	120-190	-	-	90-130	90-120	
	Ковкий чугун	ферритный	450	200-400	-	-	-	140-220	180-350	150-230	150-230	-	-	210-250	170-230
		перлитный	750	180-320	-	-	-	110-160	160-260	120-170	120-170	-	-	90-130	90-120
N	Алюминиевые сплавы	нетермообработываемые	200	-	-	-	-	-	-	-	-	-	-	-	-
		термообработываемые, термообработанные	350	-	-	-	-	-	-	-	-	-	-	-	-
	Алюминиевые питьевые сплавы	Содержание Si ≤ 12% термообработанные	250	-	-	-	-	-	-	-	-	-	-	-	-
		Содержание Si ≤ 12% термообработываемые, термообработанные	300	-	-	-	-	-	-	-	-	-	-	-	-
		Содержание Si ≤ 12% нетермообработываемые	450	-	-	-	-	-	-	-	-	-	-	-	-
Медь и медные сплавы (бронза, латунь)	Сплавы со свинцом, Pb > 1%	400	-	-	-	-	-	-	-	-	-	-	-	-	
	Латунь, бронза	300	-	-	-	-	-	-	-	-	-	-	-	-	
	Алюминиевая бронза	500	-	-	-	-	-	-	-	-	-	-	-	-	
	Медь и электролитная медь	200	-	-	-	-	-	-	-	-	-	-	-	-	
Неметаллические материалы	Твердые пластики		-	-	-	-	-	-	-	-	-	-	-	-	
	Армированные пластики		-	-	-	-	-	-	-	-	-	-	-	-	
	Твёрдая резина		-	-	-	-	-	-	-	-	-	-	-	-	
S	Жаропрочные сплавы	на базе железа - отожжённые	700	-	20-40	20-40	-	20-50	-	20-40	-	20-40	-	-	-
		- термообработанные	950	-	15-35	15-35	-	20-50	-	15-35	-	15-35	-	-	-
		на базе никеля - отожжённые	800	-	8-25	8-25	-	15-40	20-40	10-30	-	8-25	-	-	-
		на базе кобальта - литьё	1100	-	4-15	4-15	-	10-25	20-30	5-18	-	4-15	-	-	-
		- термообработанные	1200	-	4-15	4-15	-	20-35	20-30	5-18	-	4-15	-	-	-
Титановые сплавы	чистый титан	500-700	-	80-130	80-130	-	80-140	-	80-130	-	80-130	-	-	-	
	Альфа- и Бета- сплавы, упрочнённые	700-1000	-	15-35	15-35	-	25-45	-	20-40	-	15-35	-	-	-	
H	Закалённые стали	закалённые и термообработанные	1000-1350	-	-	-	-	-	-	-	-	-	-	-	
		закалённые и термообработанные	1350-1700	-	-	-	-	-	-	-	-	-	-	-	
	Высокопрочный чугун	литьё	1350	-	-	-	-	-	-	-	-	-	-	-	
Упрочнённые чугуны	термообработанный	1900	-	-	-	-	-	-	-	-	-	-	-		



Рекомендации по выбору режимов резания

Точение - Твёрдые сплавы / Твёрдые сплавы с высокопозитивной геометрией - с покрытием

ISO	Обрабатываемый материал		Твёрдость по HB	Скорость резания Vc [m/min]													
				AM350	AM35C	AR170	AR270	AR27C	AR370	AL10	AL20	AT10	AT20	PVD1	PVD2	AD2	
P	Нелегированная сталь и стальное литьё	с содержанием углерода до 0,15% C	350	180-230	170-240	250-300	200-260	200-270	190-240	220-320	180-280	220-320	180-280	200-290	160-250	-	
		с содержанием углерода до 0,45% C	650	170-190	150-200	220-250	180-220	180-230	170-200	180-290	160-250	180-290	160-250	160-260	140-220	-	
		с содержанием углерода до 0,75% C	1000	100-140	80-150	150-220	120-180	120-180	100-150	150-250	120-220	150-250	120-220	130-230	110-180	-	
	Низколегированная сталь и стальное литьё		600	170-190	150-200	250-280	180-220	210-260	170-200	180-280	160-250	180-280	160-250	160-250	140-220	-	
		900	90-150	80-160	170-220	120-180	120-190	100-160	170-250	140-230	170-250	140-230	150-230	130-200	-		
		1200	70-130	60-140	150-200	120-150	120-160	80-140	150-220	120-200	150-220	120-200	130-200	110-190	-		
Высоколегированная сталь, высоколегированная инструментальная сталь и стальное литьё	отожжённые	700	120-200	110-170	170-220	140-180	140-200	130-170	-	-	-	-	-	-	-		
	закалённые и термообработанные	1100	50-100	60-130	120-180	100-150	100-160	80-130	-	-	-	-	-	-	-		
Нержавеющая сталь и стальное литьё	ферритные/мартенситные, отожжённые мартенситные, закалённые и термообработанные	700	140-180	110-180	-	170-220	170-230	130-180	170-290	160-280	170-290	160-280	150-260	130-220	-		
		1000	110-160	90-160	150-230	130-180	130-190	110-160	140-280	130-280	140-280	130-280	120-250	110-200	-		
M	Нержавеющая сталь и стальное литьё	аустенитные и ферритно-аустенитные	450-600	120-190	100-170	150-220	150-200	150-220	100-170	140-280	140-240	140-280	140-240	120-250	120-200	-	
		закалённые	600-900	80-150	-	-	-	-	-	-	-	-	-	-	-	-	
K	Серый чугун	перлитный, ферритный	500-700	-	-	150-220	-	120-180	-	180-300	160-270	180-300	160-270	160-270	-		
		перлитный, мартенситный	700-850	-	-	130-220	-	120-180	-	160-280	140-250	160-280	140-250	140-250	-		
			800-1100	-	-	100-180	-	100-150	-	120-240	110-220	120-240	110-220	110-220	-		
	Чугун с шаровидным графитом	ферритный	550	-	-	200-360	120-160	120-170	-	140-230	130-210	140-230	130-210	120-210	-		
	перлитный	800	-	-	160-220	120-180	120-190	-	120-170	110-150	120-170	110-150	110-150	-			
Ковкий чугун	ферритный	450	-	-	180-350	-	150-230	-	150-210	130-200	150-210	130-200	130-180	-			
	перлитный	750	-	-	160-260	-	120-170	-	150-210	130-200	150-210	130-200	130-180	-			
N	Алюминиевые сплавы	нетермообработываемые	200	-	-	-	-	-	-	-	-	850-1300	850-1300	750-1200	750-1200	650-2000	
		термообработываемые, термообработанные	350	-	-	-	-	-	-	-	-	-	400-900	400-900	350-800	350-800	300-2000
	Алюминиевые литейные сплавы	Содержание Si ≤ 12% термообработанные	250	-	-	-	-	-	-	-	-	-	260-800	260-800	230-700	230-700	650-2000
		Содержание Si ≤ 12% термообработываемые, термообработанные	300	-	-	-	-	-	-	-	-	-	200-550	200-550	180-500	180-500	300-2000
		Содержание Si ≤ 12% нетермообработываемые	450	-	-	-	-	-	-	-	-	-	200-500	200-500	180-450	180-450	200-2000
Медь и медные сплавы (бронза, латунь)	Сплавы со свинцом, Pb > 1%	400	-	-	-	-	-	-	-	-	-	-	-	-	-	250-800	
	Латунь, бронза	300	-	-	-	-	-	-	-	-	-	-	-	-	-	250-800	
	Алюминиевая бронза	500	-	-	-	-	-	-	-	-	-	-	-	-	-	250-800	
	Rame e rame elettrolitico	200	-	-	-	-	-	-	-	-	-	-	-	-	-	130-400	
Неметаллические материалы	Твердые пластики		-	-	-	-	-	-	-	-	-	-	-	-	-	-	
	Армированные пластики		-	-	-	-	-	-	-	-	-	-	-	-	-	-	
	Твёрдая резина		-	-	-	-	-	-	-	-	-	-	-	-	-	-	
S	Жаропрочные сплавы	на базе железа - отожжённые	700	20-40	-	-	20-50	-	20-40	20-50	20-50	20-50	20-50	15-45	15-45	-	
		- термообработанные	950	15-35	-	-	20-50	-	15-35	20-50	20-50	20-50	20-50	15-45	15-45	-	
		на базе никеля - отожжённые	800	8-25	-	20-40	15-40	-	10-30	15-40	15-40	15-40	15-40	10-35	10-35	-	
		на базе кобальта - литьё	1100	4-15	-	20-30	10-25	-	5-18	15-30	15-30	15-30	15-30	10-25	10-25	-	
		- термообработанные	1200	4-15	-	20-30	20-35	-	5-18	15-30	15-30	15-30	15-30	10-25	10-25	-	
Титановые сплавы	чистый титан	500-700	-	-	-	20-60	-	-	-	-	-	-	-	-	-	-	
	Альфа- и Бета- сплавы, упрочнённые	700-1000	-	-	-	25-45	-	-	-	-	-	-	-	-	-	-	
H	Закалённые стали	закалённые и термообработанные	1000-1350	-	-	-	-	-	-	-	-	-	-	-	-	-	
		закалённые и термообработанные	1350-1700	-	-	-	-	-	-	-	-	-	-	-	-	-	
	Высокопрочный чугун	литые	1350	-	-	-	-	-	-	-	-	-	-	-	-	-	
Упрочнённые чугуны	термообработанный	1900	-	-	-	-	-	-	-	-	-	-	-	-	-		



Рекомендации по выбору режимов резания

Точение - Твёрдые сплавы / Твёрдые сплавы с высокопозитивной геометрией - без покрытия

ISO	Обрабатываемый материал		Твёрдость по HB	Скорость резания Vc [m/min]				
				AK1010	AK1020	AP1020	AK10	AK20
P	Нелегированная сталь и стальное литьё	с содержанием углерода до 0,15% C	350	-	-	110-160	-	-
		с содержанием углерода до 0,45% C	650	-	-	100-150	-	-
		с содержанием углерода до 0,75% C	1000	-	-	80-120	-	-
	Низколегированная сталь и стальное литьё		600	-	-	100-150	-	-
		900	-	-	80-120	-	-	
		1200	-	-	60-100	-	-	
P	Высоколегированная сталь, высоколегированная инструментальная сталь и стальное литьё	отожжённые	700	-	-	-	-	-
		закалённые и термообработанные	1100	-	-	-	-	-
P	Нержавеющая сталь и стальное литьё	ферритные/мартенситные, отожжённые, мартенситные, закалённые и термообработанные	700	-	-	-	-	-
			1000	-	-	-	-	-
M	Нержавеющая сталь и стальное литьё	аустенитные и ферритно-аустенитные закалённые	450-600 600-900	-	-	80-120	-	-
K	Серый чугун	перлитный, ферритный	500-700	120-160	120-160	-	120-160	120-160
		перлитный, мартенситный	700-850	90-140	90-140	-	90-140	90-140
			800-1100	80-140	80-140	-	80-140	80-140
	Чугун с шаровидным графитом	ферритный	550	130-170	130-170	-	130-170	130-170
перлитный		800	90-130	90-130	-	90-130	90-130	
K	Чугун с шаровидным графитом	ферритный	450	140-200	140-200	-	140-200	140-200
		перлитный	750	120-160	120-160	-	120-160	120-160
N	Алюминиевые сплавы	нетермообрабатываемые	200	300-2500	300-2500	-	300-2500	300-2500
		термообрабатываемые, термообработанные	350	200-2000	200-2000	-	200-2000	200-2000
	Алюминиевые литейные сплавы	Содержание Si ≤ 12% термообработанные	250	400-1500	400-1500	-	400-1500	400-1500
		Содержание Si ≤ 12% термообрабатываемые, термообработанные	300	400-1500	400-1500	-	400-1500	400-1500
Содержание Si ≤ 12% нетермообрабатываемые		450	200-800	200-800	-	200-800	200-800	
N	Медь и медные сплавы (бронза, латунь)	Сплавы со свинцом, Pb > 1%	400	250-600	250-600	-	250-600	250-600
		Латунь, бронза	300	200-600	200-600	-	200-600	200-600
		Алюминиевая бронза	500	150-400	150-400	-	150-400	150-400
		Медь и электролитная медь	200	150-300	150-300	-	150-300	150-300
N	Materiali non ferrosi	Твёрдые пластики		80-180	80-180	-	80-180	80-180
		Армированные пластики		60-150	60-150	-	60-150	60-150
		Твёрдая резина		100-250	100-250	-	100-250	100-250
S	Жаропрочные сплавы	на базе железа - отожжённые	700	15-40	-	-	15-40	-
		- термообработанные	950	8-28	-	-	8-28	-
		на базе никеля - отожжённые	800	10-30	-	-	10-30	-
		на базе кобальта - литьё	1100	8-25	-	-	8-25	-
		- термообработанные	1200	8-25	-	-	8-25	-
S	Титановые сплавы	чистый титан	500-700	60-120	60-120	-	60-120	60-120
		Альфа- и Бета- сплавы, упрочнённые	700-1000	30-80	30-80	-	30-80	30-180
H	Закалённые стали	закалённые и термообработанные	1000-1350	-	-	-	-	-
		закалённые и термообработанные	1350-1700	-	-	-	-	-
	Высокопрочный чугун	литьё	1350	-	-	-	-	-
H	Упрочнённые чугуны	термообработанный	1900	-	-	-	-	-



Рекомендации по выбору режимов резания

Точение - Cermet

ISO	Обрабатываемый материал		Твёрдость по HB	Скорость резания Vc [m/min]										
				AP6510	AC30C	AC90C	AP6010	ACE6	T15	AH7510	AH7520	AN8020	HSS-TiN	HSS-TiCN
P	Нелегированная сталь и стальное литьё	с содержанием углерода до 0,15% C	350	100-500	170-580	160-460	100-450	100-400	100-400	-	-	-	70-100	80-110
		с содержанием углерода до 0,45% C	650	80-500	150-540	90-430	80-450	80-370	80-370	-	-	-	65-90	70-100
		с содержанием углерода до 0,75% C	1000	50-350	100-450	60-400	50-350	50-350	а60-280	-	-	-	35-55	30-60
	Низколегированная сталь и стальное литьё		600	80-500	160-580	90-350	80-450	80-300	80-300	-	-	-	30-80	35-90
			900	70-500	120-450	80-300	70-450	70-270	70-300	-	-	-	30-80	35-90
			1200	50-350	100-400	60-300	50-350	50-250	80-220	-	-	-	30-60	35-70
Высоколегированная сталь, высоколегированная инструментальная сталь и стальное литьё	отожжённые	700	60-320	-	90-230	60-250	80-200	60-200	-	-	-	30-60	35-70	
	закалённые и термообработанные	1100	50-180	-	60-180	50-160	50-160	60-200	-	-	-	-	-	
Нержавеющая сталь и стальное литьё	ферритные/мартенситные, отожжённые мартенситные, закалённые и термообработанные	700	80-350	-	90-290	80-300	80-250	70-270	-	-	-	20-35	20-40	
		1000	80-400	-	-	80-350	80-250	70-250	-	-	-	-	-	
M	Нержавеющая сталь и стальное литьё	аустенитные и ферритно-аустенитные	450-600	80-380	-	-	80-300	80-240	80-240	-	-	-	20-35	20-40
закалённые		600-900	60-350	-	-	60-300	80-240	80-200	-	-	-	-	-	
K	Серый чугун	перлитный, ферритный	500-700	100-500	140-290	-	100-300	80-300	-	900-2000	-	-	-	-
		перлитный, мартенситный	700-850	100-380	120-260	-	100-300	80-260	-	500-900	-	-	-	-
			800-1100	100-350	90-260	-	100-300	80-240	-	300-500	-	-	-	-
	Чугун с шаровидным графитом	ферритный	550	80-350	-	80-300	100-300	80-300	80-300	-	-	-	-	-
перлитный		800	80-350	-	80-250	100-300	80-250	80-250	-	-	-	-	-	
Ковкий чугун	ферритный	450	80-350	-	80-350	100-300	80-350	80-350	900-2000	-	-	-	-	
	перлитный	750	80-350	-	60-250	100-300	60-250	60-250	500-900	-	-	-	-	
N	Алюминиевые сплавы	нетермообработываемые	200	-	-	-	-	-	-	-	-	300-3000	400-900	400-900
		термообработываемые, термообработанные	350	-	-	-	-	-	-	-	-	200-3000	140-240	150-250
	Алюминиевые литевые сплавы	Содержание Si ≤ 12% термообработанные	250	-	-	-	-	-	-	-	-	300-3000	140-240	150-250
		Содержание Si ≤ 12% термообработываемые, термообработанные	300	-	-	-	-	-	-	-	-	200-3000	140-240	150-250
		Содержание Si ≤ 12% нетермообработываемые	450	-	-	-	-	-	-	-	-	200-3000	60-130	70-140
	Медь и медные сплавы (бронза, латунь)	Сплавы со свинцом, Pb > 1%	400	-	-	-	-	-	-	-	-	800-2000	90-110	100-120
Латунь, бронза		300	-	-	-	-	-	-	-	-	800-2000	-	-	
Алюминиевая бронза		500	-	-	-	-	-	-	-	-	800-2000	-	-	
Медь и электролитная медь		200	-	-	-	-	-	-	-	-	800-2000	110-180	120-200	
Неметаллические материалы	Твёрдые пластики		-	-	-	-	-	-	-	-	-	80-140	90-150	
	Армированные пластики		-	-	-	-	-	-	-	-	400-900	-	-	
	Твёрдая резина		-	-	-	-	-	-	-	-	-	-	-	
S	Жаропрочные сплавы	на базе железа - отожжённые	700	-	-	-	-	-	-	300-500	-	-	10-20	10-25
		- термообработанные	950	-	-	-	-	-	-	250-350	-	-	10-20	10-25
		на базе никеля - отожжённые	800	-	-	-	-	-	-	280-400	-	-	10-20	10-25
		на базе кобальта - литьё	1100	-	-	-	-	-	-	200-300	-	-	-	-
		- термообработанные	1200	-	-	-	-	-	-	200-300	-	-	-	-
Титановые сплавы	чистый титан	500-700	-	-	-	-	-	-	-	-	300-500	15-30	15-35	
	Альфа- и Бета- сплавы, упрочнённые	700-1000	-	-	-	-	-	-	-	-	200-350	15-30	15-35	
H	Закалённые стали	закалённые и термообработанные	1000-1350	-	-	-	-	-	-	80-200	-	-	-	
		закалённые и термообработанные	1350-1700	-	-	-	-	-	-	50-150	-	-	-	
	Высокопрочный чугун	литьё	1350	-	-	-	-	-	60-150	-	-	-	-	
Упрочнённые чугуны	термообработанный	1900	-	-	-	-	-	-	50-150	-	-	-		

Die Tabellenwerte sind Richtwerte. Es kann notwendig sein, die Werte den jeweiligen Bearbeitungsbedingungen anzupassen.
 The data given are only approximate values. It can be necessary to adjust these data to the individual machining operation.
 Приведённые в таблице режимы являются ориентировочными. В зависимости от конкретных условий обработки, они могут подвергаться корректировке.





Рекомендации по выбору режимов резания

Резьба

ISO	Обрабатываемый материал		Твёрдость по HB	Скорость резания Vc (m/min)						
				AL100	AM7C	AM15C	AM35C	AK20(P)	AP30	HSS-TiN
P	Нелегированная сталь и стальное литьё	с содержанием углерода до 0,15% C	350	115-190	-	140-200	80-150	-	70-100	20-50
		с содержанием углерода до 0,45% C	650	100-190	-	130-180	80-150	-	70-100	20-40
		с содержанием углерода до 0,75% C	1000	70-160	-	80-160	60-120	-	50-80	15-25
	Низколегированная сталь и стальное литьё		600	85-145	-	100-155	70-130	-	70-100	20-45
			900	75-140	-	90-145	70-120	-	50-80	10-25
			1200	70-135	-	80-135	70-115	-	-	10-25
Высоколегированная сталь, высоколегированная инструментальная сталь и стальное литьё	отожжённые	700	70-110	-	70-115	60-110	-	10-80	-	
	закалённые и термообработанные	1100	50-100	-	50-100	50-90	-	20-55	-	
Нержавеющая сталь и стальное литьё	ферритные/мартенситные, отожжённые, закалённые и термообработанные	700	75-140	-	-	-	-	-	25-50	
		1000	60-120	-	-	-	-	-	20-40	
M	Нержавеющая сталь и стальное литьё	аустенитные и ферритно-аустенитные	450-600	70-130	70-150	70-120	-	-	-	
		закалённые	600-900	40-110	40-120	40-90	-	-	-	
K	Серый чугун	перлитный, ферритный	500-700	70-130	-	-	-	-	-	
		перлитный, мартенситный	700-850	60-120	-	-	-	-	-	
			800-1100	60-115	-	-	-	-	-	
	Чугун с шаровидным графитом	ферритный	550	125-160	-	-	-	-	-	
Ковкий чугун	перлитный	800	90-120	-	-	-	-	-		
	ферритный	450	80-180	-	70-150	-	70-95	-		
	перлитный	750	-	-	-	-	-	-		
N	Алюминиевые сплавы	нетермообработываемые	200	100-365	-	100-240	-	100-250	-	30-60
		термообработываемые, термообработанные	350	80-220	-	80-170	-	80-160	-	25-50
	Алюминиевые литейные сплавы	Содержание Si ≤ 12% термообработанные	250	200-400	-	-	-	80-120	-	25-50
		Содержание Si ≤ 12% термообработываемые, термообработанные	300	200-280	-	-	-	70-100	-	20-40
		Содержание Si ≤ 12% нетермообработываемые	450	60-180	-	-	-	50-120	-	15-30
Медь и медные сплавы (бронза, латунь)	Сплавы со свинцом, Pb > 1%	400	80-200	120-200	100-250	100-200	110-190	-	15-35	
	Латунь, бронза	300	80-225	-	80-200	-	70-170	-	15-35	
	Алюминиевая бронза	500	-	-	-	-	-	-	15-30	
	Медь и электролитная медь	200	120-240	120-300	100-250	100-200	110-190	-	15-35	
Неметаллические материалы	Твёрдые пластики		-	-	-	-	-	-	-	
	Армированные пластики		-	-	-	-	-	-	-	
	Твёрдая резина		-	-	-	-	-	-	-	
S	Жаропрочные сплавы	на базе железа - отожжённые	700	45-60	-	-	-	30-50	-	-
		- термообработанные	950	30-50	-	-	-	25-40	-	-
		на базе никеля - отожжённые	800	20-30	-	-	-	20-30	-	-
		на базе кобальта - литьё	1100	-	-	-	-	-	-	-
		- термообработанные	1200	15-25	-	-	-	15-25	-	-
Титановые сплавы	чистый титан	500-700	140-170	-	-	-	60-100	-	-	
Альфа- и Бета- сплавы, упрочнённые		700-1000	50-70	-	-	-	40-60	-	-	
H	Закалённые стали	закалённые и термообработанные	1000-1350	-	-	-	-	-	-	
		закалённые и термообработанные	1350-1700	-	-	-	-	-	-	
	Высокопрочный чугун	литьё	1350	-	-	-	-	-	-	
Упрочнённые чугуны	термообработанный	1900	45-60	-	45-60	-	-	-		

Bezeichnung Designation	Seite Page
7...	
70808-2 R/L	3.11
70808-3 R/L	3.11
71010-2 R/L	3.11
71010-3 R/L	3.11
71212-2 R/L	3.11
71212-3 R/L	3.11
71616-2 R/L	3.11
71616-3 R/L	3.11
A...	
A12K STFO R/L ...	3.7
A16M STFO R/L ...	3.7
AL...	1.103
A-SCFC...	1.23
A-SCLC...	1.24
A-SCLD...	1.25
A-SCLD... (abgesetzt)	1.26
A-SCUP...	1.27
A-SCXP...	1.28
A-SDQC...	1.29
A-SDUC...	1.30
A-STFC...	1.31 / 1.32
A-STUC...	1.33
A-SV95C...	1.36
A-SVLC...	1.34
A-SVOC...	1.35
A-SVVC...	1.37
A-SVXC...	1.38
A-SWFC...	1.39
A-SWLC...	1.40
A-SWUC... (abgesetzt)	1.42
AVR...	1.105
B...	
BNVR...	1.107
BNVR...-5L	1.108
C...	
CAVRC...	1.106
CCGT...	1.57
CCGT... (hochpositiv)	1.70
CCGT...-CERMET	1.81
CCGW...	1.57
CCGX...	1.57
CCMT...	1.58
CCMT...-CERMET	1.82
CCMX...	1.58 / 1.59
CCXT...	1.58
CCXT... (hochpositiv)	1.71
CDGT...	1.59
CDGT... (hochpositiv)	1.71
CDGT...-CERMET	1.82
CDGW...	1.59
CDGW...-CERMET	1.82
CLCC R ... -A7-A	3.14

Bezeichnung Designation	Seite Page
CNGM... (hochpositiv)	1.72
CNVR...	1.106
CPET...	1.60
CPET...-CERMET	1.83
CPGT...	1.60
CPGT... (hochpositiv)	1.72
CPGT...-CERMET	1.83
CPGW...	1.60
CPGW...-CERMET	1.83
CPMT...	1.60
CPMT...-CERMET	1.83
D...	
DCGT...	1.61
DCGT... (hochpositiv)	1.73
DCGT...-CERMET	1.84
DCGW...	1.61
DCGX...	1.62
DCMT...	1.61
DCMT...-CERMET	1.85
DCMX...	1.61
DCXT...	1.62
DCXT... (hochpositiv)	1.73
E...	
E-SCFC...	1.23
E-SCLC...	1.24
E-SCLD...	1.25
E-SCLD... (abgesetzt)	1.26
E-SCUP...	1.27
E-SCXP...	1.28
E-SDQC...	1.29
E-SDUC...	1.30
E-STFC...	1.32
E-SV95C...	1.36
E-SVLC...	1.34
E-SVVC...	1.37
E-SVXC...	1.38
E-SWFC...	1.39
E-SWLC...	1.40
E-SWUC...	1.41
E-SWUC... (abgesetzt)	1.42
H...	
HSAV 20 ...	4.15
HSAV 25 ...	4.15
K...	
KCGX...	1.63
KCGX... (hochpositiv)	1.74
KCGX...-CERMET	1.86
L...	
LAB...F L-R	2.9
LAB...F L-R-PF	2.9
LAB...F R/L	2.8
LAB...F R/L-PF	2.8

Bezeichnung Designation	Seite Page
LAB...F R-L	2.9
LGE...F R/L	2.13
LPET...	5.8
LPNT...	5.9
LRD...F R/L	2.14
LRD...F R/L-P	2.14
LRD...F R/L-SP	2.15
LRO...F R/L	2.16
LST...F R/L	2.10
LST...F R/L-P	2.11
LVD...F R/L	2.12
LVD...F R/L-P	2.12
M...	
M3770- ...	4.10
M472- ...	4.12
M7993- ...	4.11
MA- ...	4.9
MB- ...	4.6
MD- ...	4.6
MF- ...	4.7
MG- ...55	4.4
MG- ...60	4.4
MG- ...ISO	4.4
MG- ...NPT	4.5
MG- ...NPTF	4.5
MG- ...UN	4.5
MG- ...W	4.5
MH- ...	4.13
MK- ...	4.7
MKL- ...	4.7
MR- ...	4.8
N...	
NL...	1.103
NL...V...	1.104
NVR...	1.105
O...	
OV...	1.109
OVR...	1.109
S...	
SAV15...R/L	4.14
SAV20...R/L	4.14
SAV25...R/L	4.14
SAV30...R/L	4.14
SAV40...R/L	4.14
SC AD20.. (Mini)	5.10
SC...G.. (1.5 x D)	5.4
SC...R/L (Mini)	5.10
SC...R/L...-ALU (Mini)	5.10
SC...SP.. (2.25 x D)	5.4
SC...SP.. (3 x D)	5.5
SCAC...	1.5
SCAP...	1.6
SCGT... (hochpositiv)	1.74

Bezeichnung Designation	Seite Page
SCLC...	1.7
SCMC...	1.8
SCMT...	1.64
SCMT...-CERMET	1.86
SDAC...	1.9
SDHC...	1.10
SDJC...	1.11
SDNC...	1.12
SIN 20M ...	3.12
SLAO...	2.3
SLCO...	2.4
SLXO L...	2.6
SLXO R...	2.5
SNVR...	1.107
SNVR...-5L	1.108
S-SCLC...	1.24
S-SCLD...	1.25
S-SCLD... (abgesetzt)	1.26
S-SCUP...	1.27
S-SCXP...	1.28
S-SDQC...	1.29
S-SDUC...	1.30
S-STFC...	1.31
S-STUC...	1.33
S-SV95C...	1.36
S-SVLC...	1.34
S-SVVC...	1.37
S-SVXC...	1.38
S-SWLC...	1.40
S-SWUC... (abgesetzt)	1.42
STAC...	1.13
STGO R/L ... -A7	3.6
STGO R/L ... -A7/3	3.6
STGO R/L ... -A7/4	3.6
SVAC	1.14
SVJC...	1.15
SVVC...	1.16
SVXC...	1.17
T...	
TCGT... (hochpositiv)	1.75
TCGT...-CERMET	1.87
TCGW...	1.65
TCMT...	1.65
TCMT...-CERMET	1.87
TPMT...-CERMET	1.88
V...	
VBMT...-CERMET	1.88
VCGT...	1.66
VCGT... (hochpositiv)	1.76 / 1.77
VCGT...-CERMET	1.89
VCGW...	1.66
VCGW...-CERMET	1.89
VCGX...	1.67
VCMT...	1.67

Bezeichnung Designation	Seite Page
VCMT...-CERMET	1.89
VCXT...	1.67
VCXT... (hochpositiv)	1.77
VPGT... (hochpositiv)	1.78
VPXT... (hochpositiv)	1.78
W...	
WCGT...	1.68
WCGT... (hochpositiv)	1.79
WCGT...-CERMET	1.90
WCGW...	1.68
WCGW...-CERMET	1.90
WCMT...	1.68
WCMT...-CERMET	1.90
X...	
XLCO R/L ... -20	3.16
XLCO R/L ... -26	3.16
XLCO R/L ... -32	3.16

Bezeichnung Designation	Seite Page
----------------------------	---------------